

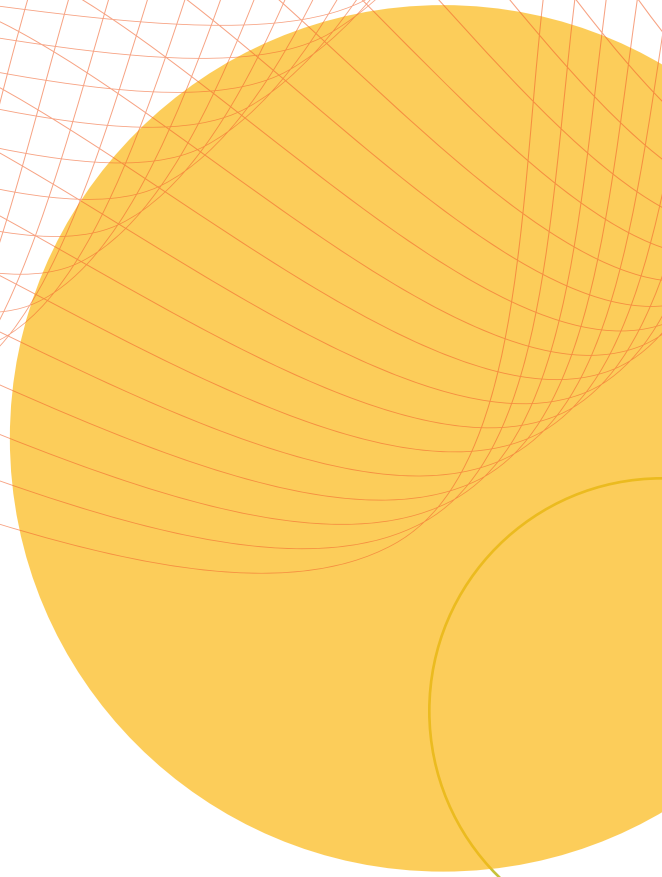

**CPC**<sup>TM</sup>

A **DOVER** COMPANY

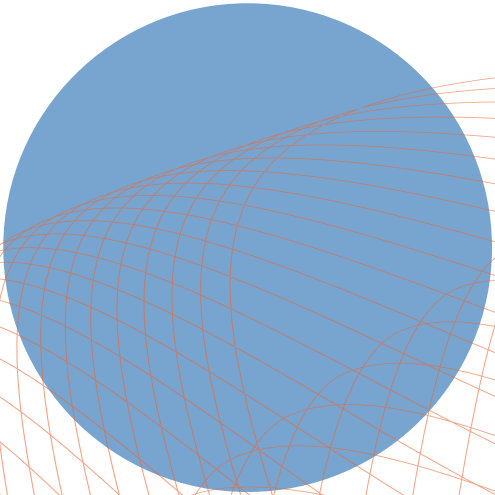

**NSF CONNECTIONS for  
FOOD & BEVERAGE**





## ***Smart fluid handling to take you forward, faster*** ● ● ●

CPC (Colder Products Company) has been designing and manufacturing quick disconnect couplings, fittings and connectors since 1978. Our broad range of products are found in thousands of applications across many life sciences, specialty industrial and chemical handling markets. Used in a wide range of products, machinery, devices and processes, CPC's innovative coupling and connection technologies allow flexible tubing to be quickly and safely connected and disconnected. The robust and easy-to-use design of CPC's quick disconnect couplings and fittings provides reliable, secure and leak-free connections for fluid and air management. CPC makes people's lives better by developing innovative high quality products that make fluid handling safe and easy.

### **WHERE TO BUY**

Find your local distributor by visiting [cpcworldwide.com](http://cpcworldwide.com) or call CPC's Customer Service at 1-800-444-2474 or 651-645-0091. You can also send an email to [info@cpcworldwide.com](mailto:info@cpcworldwide.com).

### **QUALITY**

CPC meets or exceeds our customers' expectations. Everyone is involved, from our suppliers to our distribution network, and most importantly, our employees. CPC measures and continually improves our standards of product quality, support services and overall customer and employee satisfaction. CPC's Quality System conforms to ISO 9001:2008 and ISO 13485 standards. Our cleanroom is ISO Class 7 certified.

# OUR CAPABILITIES

CPC's engineered, custom solutions improve the overall functionality and design of the equipment and processes in which they are used. Special product features include precise hose barbs for superior grip, built-in shutoff valves to prevent product spills and an easy-to-use, push-button thumb latch for quick connecting and disconnecting.

## NSF / FOOD-GRADE CONNECTIONS

CPC manufactures thousands of connection solutions specifically for the Food and Beverage marketplace. All of these products are listed under NSF/ANSI Standard 169, are made from FDA-approved materials and available with certification. All of our NSF-listed products are available with built-in shutoff valves that automatically shut off the media when you disconnect the coupling.

Applications may include:

- Office coffee service
- Water filtration
- Condiment dispensing
- Dairy processing

## VISIT US ONLINE FOR INTERACTIVE WEB TOOLS

[cpcworldwide.com](http://cpcworldwide.com)

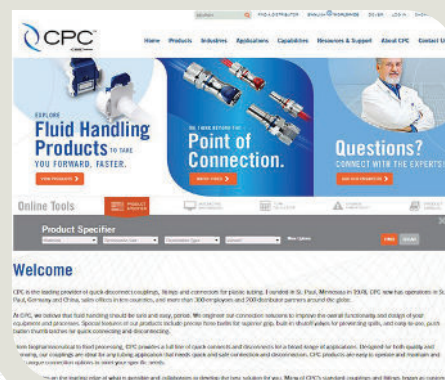

## ALSO ON THE WEB

- Part Specifier
- Chemical Compatibility
- Ask Our Engineers
- CAD Models
- Watch Product Videos
- Application Articles
- Regulatory & Compliance Documents

# TABLE OF CONTENTS

## LEGEND

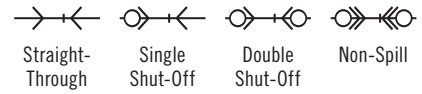

Note: Product images may not be to scale

## NSF-Grade Couplings

PAGE | DESCRIPTION



**6 LC NSF SERIES:** Durable and able to withstand higher pressure and temperature; easy one-hand connection and disconnection.

**Material:** Chrome-plated brass

**Tubing ID Sizes:** 1/4" to 3/8" (6.4mm to 9.5mm)

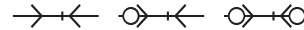

**8 APC NSF SERIES:** Features plastic thumb latch, fewer moving parts and a smooth contoured design to deliver ease-of-use and excellent flow.

**Material:** Acetal

**Tubing ID Sizes:** 1/4" to 3/8" (6.4mm to 9.5mm)

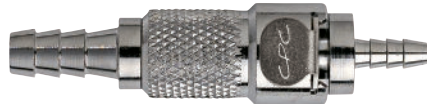

**12 MC NSF SERIES:** Durable and able to withstand higher pressure and temperature; easy one-hand connection and disconnection.

**Material:** Chrome-plated brass

**Tubing ID Sizes:** 1/8" to 1/4" (3.2mm to 6.4mm)



**14 PMC NSF SERIES:** Features one-hand connection and disconnection and integral terminations; easier to use than ball-and-sleeve designs.

**Material:** Acetal

**Tubing ID Sizes:** 1/16" to 1/4" (1.6mm to 6.4mm)

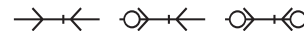

**18 PLC NSF SERIES:** Widest selection of sizes and configurations offered; resistant to most mild chemical solutions.

**Material:** Acetal

**Tubing ID Sizes:** 1/4" to 3/8" (6.4mm to 9.5mm)

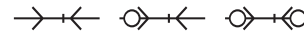

**22 HFC12 NSF SERIES:** Efficient valve design leads to high flow and exceptionally low spillage; shrouded thumb latch is easy to grip and simple to operate.

**Material:** Polypropylene

**Tubing ID Sizes:** 3/8" to 3/4" (9.5mm to 19.0mm)



**24 HFC35 NSF SERIES:** Withstand harsh environments and harmful rays without affecting performance.

**Material:** Polysulfone (white)

**Tubing ID Sizes:** 3/8" to 3/4" (9.5mm to 19.0mm)



**26 UDC NSF SERIES:** Provides closed connection to bag-in-box packaging with 38mm threaded and snap-in necks.

**Material:** Polypropylene and acetal

**Tubing ID Sizes:** 3/8" to 3/4" (9.5mm to 19.0mm)



# LC SERIES CONNECTOR



## Specifications ● ● ●

### PRESSURE:

Vacuum to 250 psi, 17.3 bar

### TEMPERATURE:

-40°F to 180°F (-40°C to 82°C)

### MATERIALS:

**Main components:** Chrome-plated brass

**Thumb latch:** Stainless steel

**Valves:** Acetal

**Valve springs:** 316 stainless steel

**External springs and pin:** Stainless steel

**O-rings:** Buna-N

**FINISH:** Chrome

### TUBING SIZES:

1/4" to 3/8" ID, 6.4mm to 9.5mm ID

**WARNING:** Pressure, temperature, chemicals, and operating environment can affect the performance of couplings. It is the customer's responsibility to test the suitability of CPC's products in their own application conditions.

**CPC's LC Series chrome-plated brass** couplings are built tough and made to last in the most demanding applications. Ideal for use with higher temperature or pressure, the LC Series features a one-hand operation for swift and easy connects and disconnects. These couplings offer the flexibility of multiple configurations and terminations to mate with both the PLC acetal and PLC12 polypropylene couplings.

## FEATURES

Brass material

Chrome plating

CPC thumb latch

Compatible

## BENEFITS

Durable construction withstands higher pressure and temperature

Attractive appearance

One-hand connection and disconnection

LC mates with PLC Series couplings

LC Air Flow, 100 psig Inlet Pressure

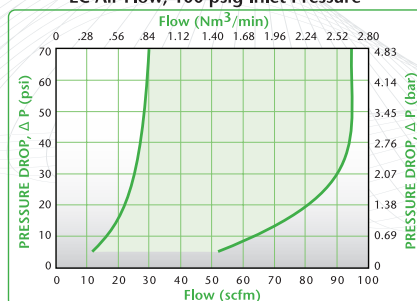

LC Water Flow

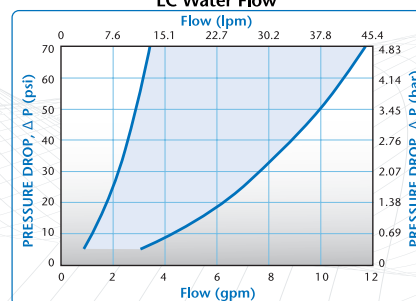

◀ These graphs are intended to give you a general idea of the performance capabilities of each product line. The shaded area of each graph represents the operating range of the product family, i.e., upper and lower values are shown. Therefore, depending on the exact coupling configurations selected, you can reasonably expect values to fall within the shaded area.

# LC DIMENSIONS

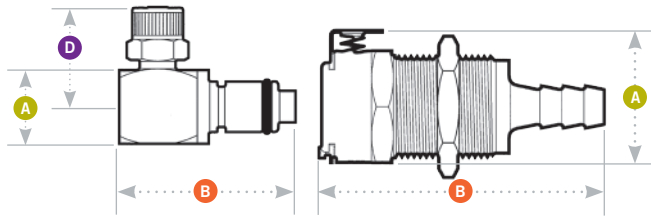

- A** = Height/Diameter
- B** = Total Length
- D** = Elbow Radial Length

## Product Dimensions

	PANEL OPENING	PANEL THICKNESS MAX.-MIN.	PANEL NUT HEX	PANEL NUT THREAD
<b>COUPLING BODIES</b>	see drawing	.50 – .05	13/16	11/16-24UNEF
<b>COUPLING INSERTS</b>	see drawing	.090 – .300	13/16	11/16-24UNEF

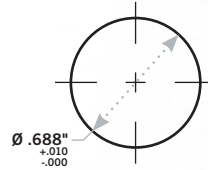

## Coupling Bodies • CHROME-PLATED BRASS



TERMINATION	TUBING/THREAD SIZE	METRIC EQ.	NSF PN	STANDARD PN	A	B
<b>IN-LINE HOSE BARB</b>	1/4" ID	6.4mm	76300	LC17004 NSF	.88	2.00
	1/4" ID	6.4mm ID	70800	LCD17004 NSF	.88	2.00
	3/8" ID	9.5mm	76400	LC17006 NSF		
	3/8" ID	9.5mm	76500	LCD17006 NSF		
<b>PANEL MOUNT HOSE BARB</b>	1/4" ID	6.4mm ID	70300	LCD16004 NSF	.88	2.00
	1/4" ID	6.4mm ID	70200	LC16004 NSF	.88	2.00
<b>IN-LINE PIPE THREAD</b>	1/4" NPT		71200	LC10004 NSF	.88	1.15

## Coupling Inserts • CHROME-PLATED BRASS



TERMINATION	TUBING/THREAD SIZE	METRIC EQ.	NSF PN	STANDARD PN	A	B	D
<b>IN-LINE HOSE BARB</b>	1/4" ID	6.4mm	70100	LC22004 NSF	.63	1.35	
	1/4" ID	6.4mm	70500	LCD22004 NSF	.63	2.00	
	3/8" ID	9.5mm	70900	LCD22006 NSF	.63	1.83	
<b>ELBOW HOSE BARB</b>	1/4" ID	6.4mm	70300	LCD23004 NSF	.62	1.43	1.28
	3/8" ID	9.5mm	71300	LCD23006 NSF	.62	1.43	1.28
<b>PANEL MOUNT HOSE BARB</b>	1/4" ID	6.4mm	72900	LC42004 NSF	.94	2.11	
<b>IN-LINE PIPE THREAD</b>	1/4" NPT		71400	LC24004 NSF	.72	1.25	
	1/4" NPT		71500	LCD24004 NSF	.72	1.68	
	1/4" BSPT		71800	LC24004BSPT NSF	.72	1.25	
	1/4" BSPT		71900	LCD24004BSPT NSF	.72	1.68	
	3/8" NPT		72200	LC24006 NSF	.87	1.25	
	3/8" NPT		72300	LCD24006 NSF	.87	1.55	
	3/8" BSPT		72400	LC24006BSPT NSF	.87	1.25	
	3/8" BSPT		72500	LCD24006BSPT NSF	.87	1.55	
<b>IN-LINE PIPE THREAD (FEMALE)</b>	1/4" NPT		76400	LC26004 NSF	.72	1.25	
<b>PANEL MOUNT PIPE THREAD</b>	1/4" PTF		72600	LC40004 NSF	.94	1.83	
	3/8" PTF		70700	LCD40006 NSF	.94	2.11	

# APC SERIES CONNECTOR

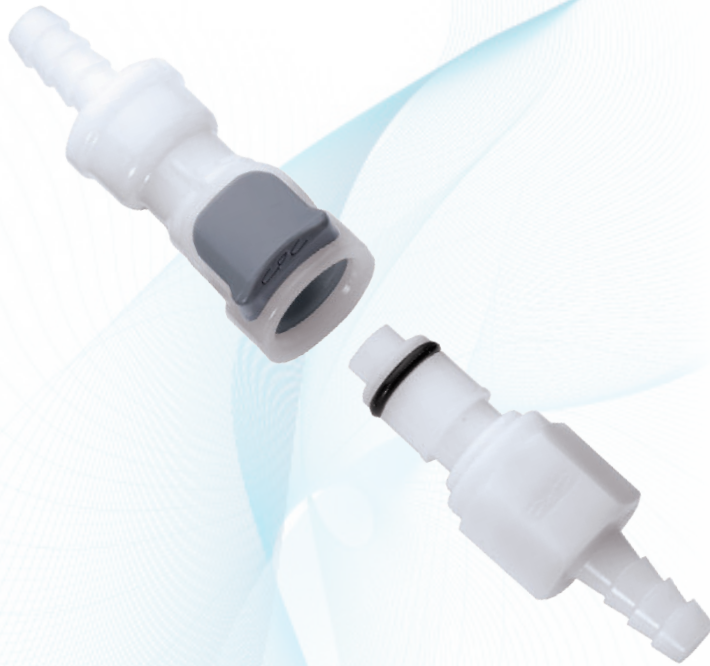

## Specifications ● ● ●

### PRESSURE:

Vacuum to 120 psi, 8.3 bar

### TEMPERATURE:

-40°F to 180°F (-40°C to 82°C)

### MATERIALS:

**Main components and valves:** Acetal

**Thumb latch:** Acetal

**Valve springs:** 316 stainless steel

**External springs and pin:** Stainless steel

**O-rings:** Buna-N

**COLOR:** Natural white with light gray latch

### TUBING SIZES:

1/4" to 3/8" ID, 6.4mm to 9.5mm ID

**WARNING:** Pressure, temperature, chemicals, and operating environment can affect the performance of couplings. It is the customer's responsibility to test the suitability of CPC's products in their own application conditions.

The 1/4" flow APC Series couplings feature a plastic thumb latch, fewer moving parts and a smooth contoured design to deliver ease-of-use and excellent flow in a compact size. The APC Series includes couplings with valves and thumb latch shrouds. A more rugged design on some models adds durability to increase the APC's application range.

## FEATURES

Plastic thumb latch

Shrouded thumb latch

Integral terminations

## BENEFITS

No exposed metal parts

Protects against accidental disconnects

Fewer leak points, shorter assemblies, faster installations

APC Air Flow, 100 psig Inlet Pressure

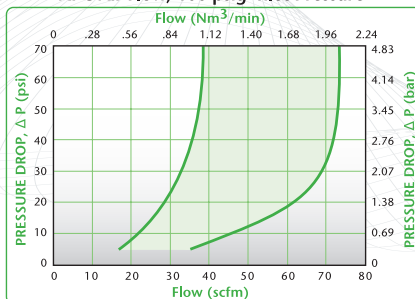

APC Water Flow

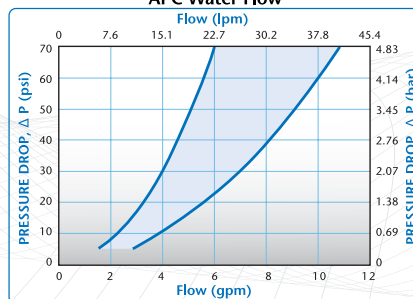

◀ These graphs are intended to give you a general idea of the performance capabilities of each product line. The shaded area of each graph represents the operating range of the product family, i.e., upper and lower values are shown. Therefore, depending on the exact coupling configurations selected, you can reasonably expect values to fall within the shaded area.

## DID YOU KNOW?

**THE SHELF LIFE OF A CONNECTOR IS DEPENDENT UPON THE CONNECTOR MATERIALS AND THE STORAGE CONDITIONS.** CPC manufactures quick disconnect couplings and connections made from a variety of metal, plastic and elastomeric raw materials. In general, it is best to store any CPC product in an environment shielded from light at a temperature between 50°F and 90°F.

The shelf life of CPC couplings and connections is estimated to be 3 years minimum if the storage conditions comply with those shown above.

**Note:** For product containing lubricated o-rings, the lubricant will dry out over time. Prior to use, it may be advisable to re-lubricate external o-rings. For product containing silicone o-rings, if lube is allowable, use of a synthetic lube is recommended.

### Liquid Flow Rate Information for Couplings

The chart below shows the flow rate for CPC couplings. Each coupling was tested with water at 70°F (21°C). To determine flow rates for specific coupling configurations use the formula at the right.

$$Q = C_v \sqrt{\frac{\Delta P}{S}}$$

- Q = Flow rate in gallons per minute
- C<sub>v</sub> = Average coefficient across various flow rates (see chart)
- ΔP = Pressure drop across coupling (psi)
- S = Specific gravity of liquid

#### C<sub>v</sub> VALUES FOR APC COUPLINGS

BODIES	INSERTS	APC 20004	APCD 20004	APC 20006	APCD 20006	APC 22004	APCD 22004	APC 22006	APCD 22006	APC 24004	APCD 24004	APC 24006	APCD 24006
	APC10004	0.4	0.4	1.2	0.9	1.0	0.9	2.0	0.9	1.9	0.8	1.7	0.8
	APCD10004	0.36	0.4	1.0	0.7	1.0	0.7	0.8	0.7	1.2	0.6	0.8	0.6
	APC10006	0.4	0.4	1.2	0.9	1.2	0.7	1.8	0.9	2.0	0.9	1.7	0.8
	APCD10006	0.37	0.4	1.3	0.8	0.6	0.5	1.1	0.7	1.3	0.7	1.0	0.7
	APC13004SH	0.38	0.5	0.5	0.4	0.4	0.4	0.5	0.4	0.5	0.4	0.4	0.4
	APCD13004SH	0.38	0.5	0.4	0.4	0.4	0.4	0.4	0.4	0.4	0.4	0.4	0.4
	APC13006SH	0.38	0.4	1.0	0.7	0.9	0.6	1.1	0.7	1.1	0.7	1.0	0.7
	APCD13006SH	0.37	0.4	0.8	0.6	0.7	0.5	0.8	0.6	0.9	0.6	0.8	0.6
	APC17004SH	0.38	0.4	0.8	0.6	1.0	0.7	0.9	0.7	0.8	0.6	0.7	0.6
	APCD17004SH	0.38	0.4	0.7	0.5	0.8	0.6	0.7	0.6	0.7	0.5	0.6	0.5
	APC17006SH	0.4	0.4	1.2	0.9	1.4	0.9	1.4	0.9	2.0	0.9	1.9	0.8
	APCD17006SH	0.4	0.4	1.2	0.8	1.3	0.8	1.2	0.7	1.2	0.7	1.1	0.7

#### NOTES:

# APC DIMENSIONS

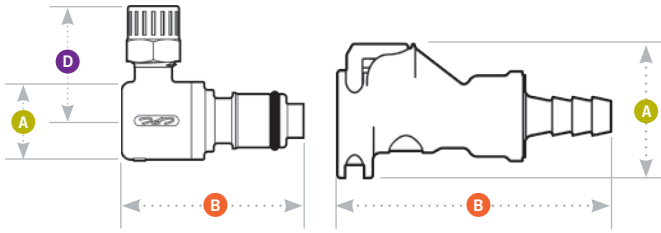

- A** = Height/Diameter
- B** = Total Length
- D** = Elbow Radial Length

## Panel Dimensions

	PANEL OPENING	PANEL THICKNESS MAX.-MIN.	PANEL NUT HEX	PANEL NUT THREAD
<b>COUPLING BODIES</b>	see drawing	.05- .02	13/16	11/16-24UNF

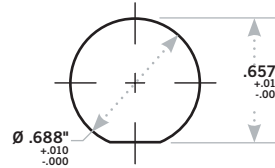

## Coupling Bodies • ACETAL



### TERMINATION IN-LINE PIPE THREAD

TUBING/THREAD SIZE	METRIC EQ.	NSF PN	STANDARD PN	A	B
1/4" NPT		44400	APC10004 NSF	.93	1.40
1/4" NPT		45600	APCD10004 NSF	.93	1.40
3/8" NPT		49200	APC10006	.93	1.40
3/8" NPT		45700	APCD10006 NSF	.93	1.40
3/8" BSPT		9203301	APCD10006BPST NSF	.93	1.40

### IN-LINE HOSE BARB

1/4" ID	6.4mm ID	40700	APC17004 NSF	.93	1.35
3/8" ID	9.5mm ID	40800	APC17006 NSF	.93	1.35

### IN-LINE HOSE BARB WITH SHROUD

1/4" ID	6.4mm ID	42100	APCD17004SH NSF	1.30	2.07
3/8" ID	9.5mm ID	42200	APCD17006SH NSF	1.30	2.07

### IN-LINE WITH SHROUD FERRULELESS POLYTUBE FITTING, PTF†

1/4" OD, .17" ID	6.4mm OD, 4.3mm ID	49300	APC13004SH NSF	1.30	1.94
1/4" OD, .17" ID	6.4mm OD, 4.3mm ID	43200	APCD13004SH NSF	1.30	1.94
3/8" OD, .25" ID	9.5mm OD, 6.4mm ID	43300	APCD13006SH NSF	1.03	2.10

### IN-LINE FLARE (FEMALE)

1/4" Flare		42000	APC NSF NON-VALVED BODY		
------------	--	-------	-------------------------	--	--

### PANEL MOUNT FERRULELESS POLYTUBE FITTING, PTF†

1/4" OD, .17" ID	6.4mm OD, 4.3mm ID	9207100	APCD12004	1.03	1.97
------------------	--------------------	---------	-----------	------	------

### PANEL MOUNT HOSE BARB

1/4" ID	6.4mm ID	9207900	APC16004 NSF	1.03	2.10
1/4" ID	6.4mm ID	9208200	APCD16004 NSF	1.03	2.10
3/8" ID	9.5mm ID	9208400	APCD16006 NSF	1.03	2.10

### PANEL MOUNT FEMAL THREAD

5/8-UNF		45500	APC NSF VALVED BODY		
---------	--	-------	---------------------	--	--

### IN-LINE COMPRESSION

1/4" Compression		9203800	APC NSF NON-VALVED BODY		
1/4" Compression		46000	APC NSF VALVED BODY		
3/8" Compression		46100	APC NSF VALVED BODY		

All measurements are in inches (millimeters) unless otherwise noted. Tubing must meet stated inside and outside diameters.  
†NOTE: CPC's Ferruleless Polytube Fitting terminations do not require ferrules to achieve a secure connection, which makes them easier to use and reuse. PTF fittings are designed for semi-rigid tubing, i.e., polyethylene, nylon, polyurethane, etc.

## Coupling Inserts • ACETAL



**TERMINATION**  
**IN-LINE**  
**PIPE THREAD**

TUBING/THREAD SIZE	METRIC EQ.	NSF PN	STANDARD PN	A	B	D
1/4" NPT		42300	APC24004 NSF	.72	1.43	
1/4" NPT		42400	APCD24004 NSF	.72	1.77	
3/8" NPT		42500	APC24006 NSF	.72	1.50	
3/8" NPT		48600	APCD24006 NSF	.72	1.64	

**IN-LINE**  
**FERRULELESS**  
**POLYTUBE FITTING,**  
**PTF†**

1/4" OD, .17" ID	6.4mm OD, 4.3mm ID	43400	APCD20004 NSF	.72	1.99	
3/8" OD, .25" ID	9.5mm OD, 6.4mm ID	43500	APCD20006 NSF	.72	1.91	

**IN-LINE**  
**HOSE BARB**

1/4" ID	6.4mm ID	40900	APC22004 NSF	.60	1.40	
1/4" ID	6.4mm ID	42600	APCD22004 NSF	.72	2.10	
3/8" ID	9.5mm ID	41000	APC22006 NSF	.63	1.40	
3/8" ID	9.5mm ID	42700	APCD22006 NSF	.72	1.92	

**ELBOW**  
**FERRULELESS**  
**POLYTUBE FITTING,**  
**PTF†**

1/4" OD, .17" ID	6.4mm OD, 4.3mm ID	49500	APC21004 NSF	1.22	1.32	.91
1/4" OD, .17" ID	6.4mm OD, 4.3mm ID	43000	APCD21004 NSF	1.22	1.45	.91
3/8" OD, .25" ID	9.5mm OD, 6.4mm ID	43100	APCD21006 NSF	1.27	1.46	.96

**ELBOW**  
**HOSE BARB**

1/4" ID	6.4mm ID	46200	APC23004 NSF	.63	1.20	.96
1/4" ID	6.4mm ID	42800	APCD23004 NSF	.63	1.45	.96
3/8" ID	9.5mm ID	44700	APC23006 NSF	.63	1.20	.96
3/8" ID	9.5mm ID	42900	APCD23006 NSF	.63	1.50	.96

**IN-LINE**  
**COMPRESSION**

1/4" Compression		44900	APC NSF VALVED INSERT			
3/8" Compression		45000	APC NSF VALVED INSERT			

All measurements are in inches (millimeters) unless otherwise noted. Tubing must meet stated inside and outside diameters.  
†NOTE: CPC's Ferruleless Polytube Fitting terminations do not require ferrules to achieve a secure connection, which makes them easier to use and reuse. PTF fittings are designed for semi-rigid tubing, i.e., polyethylene, nylon, polyurethane, etc.

# MC SERIES CONNECTOR



**CPC's MC Series chrome-plated brass couplings** are built tough and made to last in the most demanding applications. Ideal for use with higher temperatures or pressures, MC Series couplings feature one-hand operation for swift and easy connects and disconnects. These couplings offer the flexibility of multiple configurations and terminations and mate with both PMC acetal and PMC12 polypropylene couplings.

## Specifications ● ● ●

### PRESSURE:

Vacuum to 250 psi, 17.3 bar

### TEMPERATURE:

-40°F to 180°F (-40°C to 82°C)  
(High temperature versions available with ratings to 400°F)

### MATERIALS:

**Main components:**

Chrome-plated brass

**Thumb latch:** Stainless steel

**Valves:** Acetal

**Valve spring:** 316 stainless steel

**External springs and pin:** Stainless steel

**O-rings:** Buna-N

### FINISH:

Chrome

### TUBING SIZES:

1/8" to 1/4" ID, 3.2mm to 6.4mm ID

**WARNING:** Pressure, temperature, chemicals, and operating environment can affect the performance of couplings. It is the customer's responsibility to test the suitability of CPC products in their own application conditions. Use the graph to the right as a guide.

## FEATURES

Brass material

CPC thumb latch

Compatible

## BENEFITS

Durable and able to withstand higher pressure and temperature

One-hand connection and disconnection

MC mates with PMC and PMC12 Series couplings

MC Air Flow, 100 psig Inlet Pressure

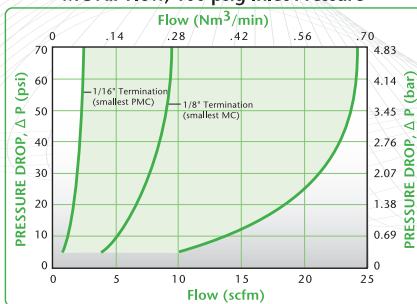

MC Water Flow

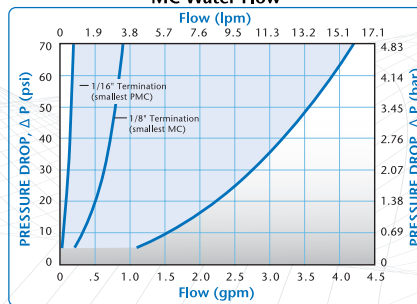

◀ These graphs are intended to give you a general idea of the performance capabilities of each product line. The shaded area of each graph represents the operating range of the product family, i.e., upper and lower values are shown. Therefore, depending on the exact coupling configurations selected, you can reasonably expect values to fall within the shaded area.

# MC DIMENSIONS

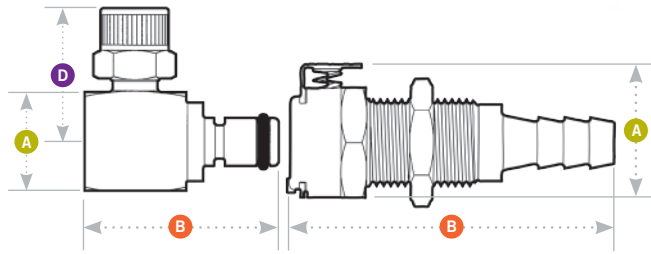

- A** = Height/Diameter
- B** = Total Length
- D** = Elbow Radial Length

## Panel Dimensions

	PANEL OPENING	PANEL THICKNESS MAX. - MIN.	PANEL NUT HEX	PANEL NUT THREAD
<b>COUPLING BODIES</b> (except male thread)	see drawing	.50 - .05	5/8	1/2-24UNS
<b>MALE THREAD</b>	see drawing	.21 - .06	5/8	1/2-24UNS
<b>COUPLING INSERTS</b>	see drawing	.30 - .06	5/8	1/2-24UNS

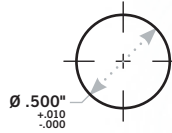

## Coupling Bodies • CHROME-PLATED BRASS



**TERMINATION**  
**IN-LINE**  
**PIPE THREAD**

**IN-LINE**  
**FERRULELESS**  
**POLYTUBE FITTING,**  
**PTF†**

**IN-LINE**  
**HOSE BARB**

**TUBING/THREAD SIZE**    **METRIC EQ.**

1/8" NPT  
1/8" NPT  
1/4" NPT  
1/4" NPT

15200  
15500  
15800  
15900

**NSF PN**

15200  
15500  
15800  
15900

**STANDARD PN**

MC1002 NSF  
MCD1002 NSF  
MC1004 NSF  
MCD1004 NSF

**A**

.76  
.76  
.76  
.76

**B**

1.00  
1.00  
1.10  
1.10

1/4" OD, .17" ID  
1/4" OD, .17" ID

6.4mm OD, 4.3mm ID  
6.4mm OD, 4.3mm ID

16800  
16900

MC1304 NSF  
MCD1304 NSF

.76  
.76

1.77  
1.77

1/8" ID  
1/4" ID

3.2mm ID  
6.4mm ID

17100  
17200

MCD1702 NSF  
MCD1704 NSF

.76  
.76

1.67  
1.89

## Coupling Inserts • CHROME-PLATED BRASS



**TERMINATION**  
**IN-LINE**  
**PIPE THREAD**

**IN-LINE**  
**PIPE THREAD**  
**(FEMALE)**

**PANEL MOUNT**  
**FERRULELESS**  
**POLYTUBE FITTING,**  
**PTF†**

**PANEL MOUNT**  
**HOSE BARB**

**IN-LINE**  
**FERRULELESS**  
**POLYTUBE FITTING,**  
**PTF†**

**IN-LINE**  
**HOSE BARB**

**ELBOW**  
**HOSE BARB**

**TUBING/THREAD SIZE**    **METRIC EQ.**

1/8" NPT  
1/8" NPT  
1/4" NPT

17300  
17400  
18000

**NSF PN**

17300  
17400  
18000

**STANDARD PN**

MC2402 NSF  
MCD2402 NSF  
MCD2404 NSF

**A**

.58  
.58  
.65

**B**

1.03  
1.43  
1.43

**D**

1/8" NPT Female  
1/4" NPT Female

17500  
18200

17500  
18200

MC2602 NSF  
MCD2604 NSF

.58  
.72

.95  
1.82

1/4" OD, .17" ID

6.4mm OD, 4.3mm ID

18600

MCD4004 NSF

.72

1.85

1/8" ID

3.2mm ID

18800

MCD4202 NSF

.72

1.75

1/4" OD, .17" ID  
1/4" OD, .17" ID

6.4mm OD, 4.3mm ID  
6.4mm OD, 4.3mm ID

19100  
19200

MC2004 NSF  
MCD2004 NSF

.58  
.58

1.15  
1.55

1/8" ID  
1/4" ID

3.2mm ID  
6.4mm ID

19400  
19600

MCD2202 NSF  
MCD2204 NSF

.58  
.58

1.05/1.65  
1.25/1.67

1/8" ID  
1/4" ID

3.2mm ID  
6.4mm ID

19900  
15100

MC2302 NSF  
MCD2304 NSF

.62  
.63

1.18  
1.28

.76  
.76

All measurements are in inches (millimeters) unless otherwise noted. Tubing must meet stated inside and outside diameters. †Note: CPC's Ferruleless PTF (polytube fitting) terminations do not require ferrules to achieve a secure connection and are therefore easier to use and reuse. PTF fittings are designed for semi-rigid tubing, i.e., polyethylene, nylon, polyurethane, etc.

# PMC SERIES CONNECTOR



## Specifications ● ● ●

### PRESSURE:

Vacuum to 120 psi, 8.3 bar

### TEMPERATURE:

-40°F to 180°F (-40°C to 82°C)

### MATERIALS:

Main components and valves: Acetal

Thumb latch: Stainless steel

Valve spring: 316 stainless steel

External springs and pin: Stainless steel

O-rings: Buna-N

### COLOR:

Natural white, others available

### TUBING SIZES:

1/16" to 1/4" ID, 1.6mm to 6.4mm ID

**WARNING:** Pressure, temperature, chemicals, and operating environment can affect the performance of couplings. It is the customer's responsibility to test the suitability of CPC products in their own application conditions.

**The 1/8" flow PMC** coupling covers a wide variety of general-purpose applications. Featuring the CPC thumb latch, the PMC is easier to use than ball-and-sleeve designs. One-hand connection/disconnection and integral terminations make the PMC the choice for ease of use and manufacture.

## FEATURES

- Hose barb shroud
- Integral terminations
- Compatible
- Clicks when connected

## BENEFITS

- Extra protection for the 1/16" hose barb
- Fewer leak points, shorter assemblies, faster installations
- Mates with PMC12 and MC Series couplings
- Assurance of a reliable connection

⚠ These graphs are intended to give you a general idea of the performance capabilities of each product line. The shaded area of each graph represents the operating range of the product family, i.e., upper and lower values are shown. Therefore, depending on the exact coupling configurations selected, you can reasonably expect values to fall within the shaded area.

PMC Air Flow, 100 psig Inlet Pressure

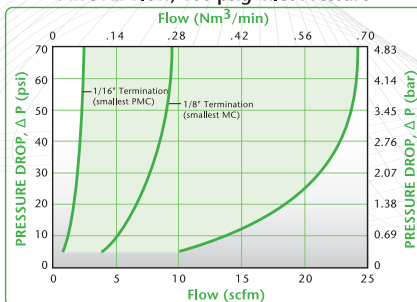

PMC Water Flow

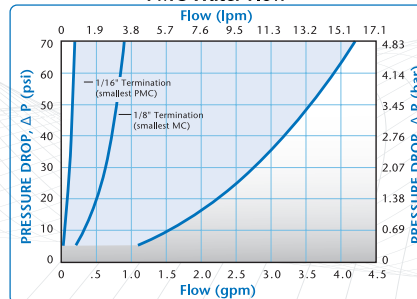

PMC Pressure Range

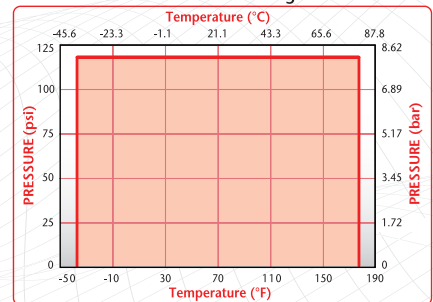

**NOTES:**



**Liquid Flow Rate Information for Couplings**

The chart below shows the flow rate for CPC couplings. Each coupling was tested with water at 70°F (21°C). To determine flow rates for specific coupling configurations use the formula at the right.

$$Q = C_v \sqrt{\frac{\Delta P}{S}}$$

- Q = Flow rate in gallons per minute
- C<sub>v</sub> = Average coefficient across various flow rates (see chart)
- ΔP = Pressure drop across coupling (psi)
- S = Specific gravity of liquid

**C<sub>v</sub> VALUES FOR 1/8" FLOW PMC COUPLINGS**

INSERTS BODIES	PMC 2004	PMCD 2004	PMC 2006	PMCD 2006	PMC 2202	PMCD 2202	PMC 2204	PMCD 2204	PMC 2402	PMCD 2402	PMC 2404	PMCD 2304	PMC 2602	PMCD 2304	PMC 2104	PMCD 2304	PMC 2203	PMCD 2203	PMC 2201	PMCD 2201
PMC1002	.40	.18	.50	.19	.25	.16	.50	.19	.50	.20	.51	.19	.50	.50	.38	.24	.30	.17	.03	.03
PMCD1002	.27	.18	.31	.18	.24	.16	.28	.20	.26	.20	.29	.18	.26	.26	.27	.24	.25	.17	.03	.03
PMC1004	.40	.21	.50	.24	.26	.18	.50	.24	.50	.20	.51	.24	.50	.50	.38	.26	.30	.19	.03	.03
PMCD1004	.29	.19	.32	.23	.25	.17	.30	.23	.27	.21	.28	.23	.27	.28	.29	.24	.25	.18	.03	.03
PMC1204	.40	.18	.50	.18	.25	.16	.40	.18	.40	.16	.36	.18	.40	.40	.38	.21	.30	.17	.03	.03
PMCD1204	.21	.17	.22	.17	.20	.16	.22	.17	.21	.17	.20	.17	.21	.22	.21	.18	.21	.16	.03	.03
PMC1602	.23	.15	.28	.18	.19	.14	.27	.15	.27	.15	.28	.18	.27	.27	.23	.16	.20	.14	.03	.03
PMCD1602	.19	.15	.19	.15	.17	.14	.19	.15	.18	.15	.18	.15	.18	.19	.19	.15	.18	.14	.03	.03
PMC1604	.33	.23	.44	.24	.24	.18	.44	.23	.44	.20	.38	.24	.38	.44	.33	.26	.26	.19	.03	.03
PMCD1604	.23	.17	.26	.21	.22	.16	.26	.21	.26	.19	.25	.21	.21	.26	.23	.24	.22	.16	.03	.03
PMC1703	.25	.20	.30	.20	.20	.17	.30	.20	.30	.19	.28	.20	.28	.30	.25	.18	.21	.17	.03	.03
PMCD1703	.20	.17	.20	.17	.19	.15	.21	.17	.19	.17	.20	.17	.19	.20	.20	.16	.19	.16	.03	.03
PMC1701	.03	.03	.03	.03	.03	.03	.03	.03	.03	.03	.03	.03	.03	.03	.03	.03	.03	.03	.03	.02
PMCD1701	.03	.03	.03	.03	.03	.03	.03	.03	.03	.03	.03	.03	.03	.03	.03	.03	.03	.03	.03	.02

# PMC DIMENSIONS

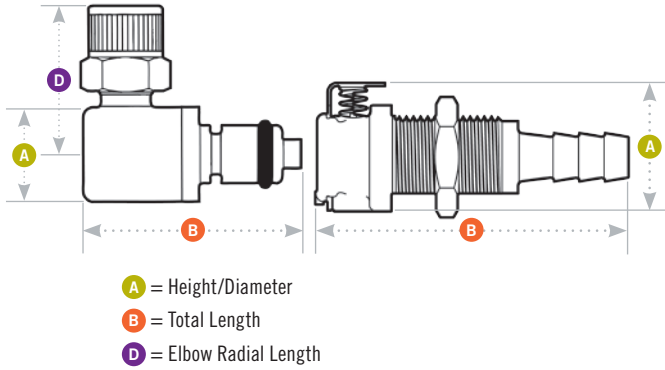

## Panel Dimensions

	PANEL OPENING	PANEL THICKNESS MAX. - MIN.	PANEL NUT HEX	PANEL NUT THREAD
<b>COUPLING BODIES</b>	see drawing	.50 - .05	5/8	1/2-24UNS
<b>COUPLING INSERTS</b>	1/2	.30 - .05	5/8	1/2-24UNS

## Coupling Bodies • ACETAL

	TUBING/THREAD SIZE	METRIC EQ.	NSF PN	STANDARD PN	<span style="color: green;">A</span>	<span style="color: red;">B</span>
<b>TERMINATION IN-LINE PIPE THREAD</b>	1/8" NPT		11700	PMC1002 NSF	.79	1.00
	1/8" NPT		11800	PMCD1002 NSF	.79	1.00
	1/8" BSPT		12000	PMCD1002BSPT NSF	.79	1.00
	1/4" NPT		10700	PMG1004 NSF	.79	1.10
	1/4" NPT		12100	PMCD1004 NSF	.79	1.10
<b>PANEL MOUNT FERRULELESS POLYTUBE FITTING, PTF†</b>	1/4" OD, .17" ID	6.4mm OD, 4.3mm ID	12400	PMC1204 NSF	.77	1.72
	1/4" OD, .17" ID	6.4mm OD, 4.3mm ID	12500	PMCD1204 NSF	.77	1.72
<b>PANEL MOUNT HOSE BARB</b>	1/8" ID	3.2mm ID	12600	PMC1602 NSF	.77	1.65
	1/8" ID	3.2mm ID	12700	PMCD1602 NSF	.77	1.65
	3/16" ID	4.8mm ID	9001800	PMCD1603 NSF	.77	1.85
	1/4" ID	6.4mm ID	12900	PMCD1604 NSF	.77	1.85
<b>PANEL MOUNT FEMALE THREAD</b>	10-32 UNF		9007200	PMC181032 NSF	.77	1.25
<b>IN-LINE HOSE BARB</b>	1/8" ID	3.2mm ID	13200	PMC1702 NSF	.81	1.45
	1/8" ID	3.2mm ID	13300	PMCD1702 NSF	.81	1.65
	3/16" ID	4.8mm ID	9001900	PMC1703 NSF	.81	1.65
	1/4" ID	6.4mm ID	10900	PMC1704 NSF	.81	1.65
	1/4" ID	6.4mm ID	11400	PMCD1704 NSF	.81	1.85

All measurements are in inches (millimeters) unless otherwise noted. Tubing must meet stated inside and outside diameters. †NOTE: CPC's Ferruleless PTF (polytube fitting) terminations do not require ferrules to achieve a secure connection and are therefore easier to use and reuse. PTF fittings are designed for semi-rigid tubing, i.e., polyethylene, nylon, polyurethane, etc.

## Coupling Inserts • ACETAL



**TERMINATION  
IN-LINE  
PIPE THREAD**

TUBING/THREAD SIZE	METRIC EQ.	NSF PN	STANDARD PN	A	B	D
1/8" NPT		13400	PMC2402 NSF	.58	1.03	
1/8" BSPT		13500	PMC2402BSPT NSF	.58	1.03	
1/4" NPT		13700	PMCD2404 NSF	.65	1.42	

**PANEL MOUNT  
FERRULELESS  
POLYTUBE FITTING,  
PTF†**

1/4" OD, .17" ID	6.4mm OD, 4.3mm ID	14100	PMCD4004 NSF	.72	1.82	
------------------	--------------------	-------	--------------	-----	------	--

**PANEL MOUNT  
HOSE BARB**

1/8" ID	3.2mm ID	14200	PMC4202 NSF	.72	1.63	
1/8" ID	3.2mm ID	14300	PMCD4202 NSF	.72	1.75	
1/4" ID	6.4mm ID	11000	PMCD4204 NSF	.72	1.95	

**IN-LINE  
FERRULELESS  
POLYTUBE FITTING,  
PTF†**

1/4" OD, .17" ID	6.4mm OD, 4.3mm ID	14500	PMC2004 NSF	.58	1.15	
1/4" OD, .17" ID	6.4mm OD, 4.3mm ID	14600	PMCD2004 NSF	.58	1.57	

**IN-LINE  
HOSE BARB**

1/8" ID	3.2mm ID	14700	PMC2202 NSF	.50	1.00	
1/8" ID	3.2mm ID	10400	PMCD2202 NSF	.50	1.67	
3/16" ID	4.8mm ID	90019003	PMC2203 NSF	.50	1.20	
1/4" ID	6.4mm ID	11600	PMC2204 NSF	.50	1.22	
1/4" ID	6.4mm ID	10800	PMCD2204 NSF	.50	1.70	

**ELBOW  
FERRULELESS  
POLYTUBE FITTING,  
PTF†**

1/4" OD, .17" ID	6.4mm OD, 4.3mm ID	10600	PMC2104 NSF	.50	1.17	.77
------------------	--------------------	-------	-------------	-----	------	-----

**ELBOW  
HOSE BARB**

1/8" ID	3.2mm ID	14900	PMC2302 NSF	.50	.85	.75
1/8" ID	3.2mm ID	15000	PMCD2302 NSF	.50	1.21	.69
1/4" ID	6.4mm ID	9000100	PMC2304 NSF	.50	1.00	.95
1/4" ID	6.4mm ID	9000200	PMCD2304 NSF	.50	1.21	.90

All measurements are in inches (millimeters) unless otherwise noted. Tubing must meet stated inside and outside diameters. Couplings are pictured with valves unless otherwise noted. †NOTE: CPC's Ferruleless PTF (polytube fitting) terminations do not require ferrules to achieve a secure connection and are therefore easier to use and reuse. PTF fittings are designed for semi-rigid tubing, i.e., polyethylene, nylon, polyurethane, etc.

# PLC SERIES CONNECTOR



The 1/4" flow PLC Series is proven worldwide in thousands of applications and offers the widest selection of sizes and configurations. PLC couplings are injection molded from acetal thermoplastic and are resistant to most mild chemical solutions. One-hand connection/disconnection, plus integral terminations make the PLC Series the choice for ease of use and manufacture.

## Specifications ● ● ●

### PRESSURE:

Vacuum to 120 psi, 8.3 bar

### TEMPERATURE:

-40°F to 180° F (-40°C to 82°C)

### MATERIALS:

**Main components and valves:** Acetal

**Thumb latch:** Stainless steel

**Valve spring:** 316 stainless steel

**External springs and pin:** Stainless steel

**O-rings:** Buna-N

**COLOR:** Natural white, others available

### TUBING SIZES:

1/4" to 3/8" ID, 6.4mm to 9.5mm ID

#### JG® TUBING SPECIFICATIONS:

**Tube tolerances:** 1/4" OD, +0.001/-0.004 | 3/8" OD, +0.001/-0.004

**Tube Types:** Plastic tube: Polyethylene, nylon, polyurethane. For soft or thin wall tubing with JG® terminations, tube supports are recommended.

**Metal tube:** Brass, copper and mild steel

## FEATURES

CPC thumb latch

Integral terminations

Clicks when connected

Compatible

## BENEFITS

One-hand connection and disconnection

Fewer leak points, shorter assemblies, faster installations

Assurance of a reliable connection

Mates with LC and PLC12 Series couplings

⚠ These graphs are intended to give you a general idea of the performance capabilities of each product line. The shaded area of each graph represents the operating range of the product family, i.e., upper and lower values are shown. Therefore, depending on the exact coupling configurations selected, you can reasonably expect values to fall within the shaded area.

PLC Air Flow, 100 psig Inlet Pressure

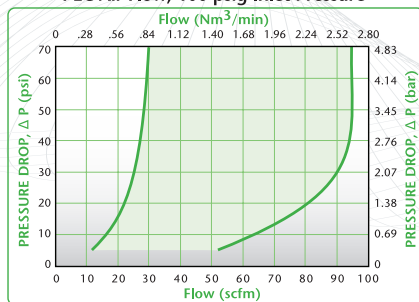

PLC Water Flow

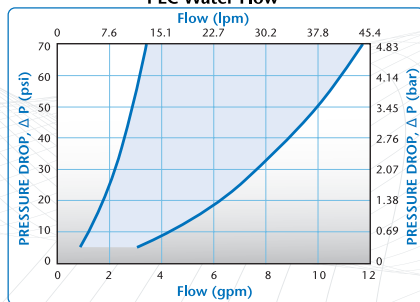

PLC Pressure Range

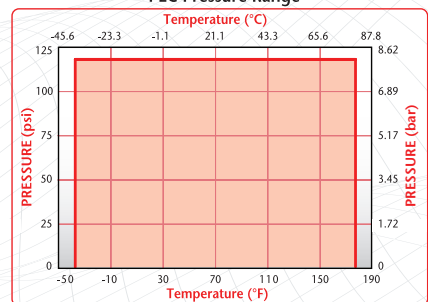

**NOTES:**

**Liquid Flow Rate Information for Couplings**

The chart below shows the flow rate for CPC couplings. Each coupling was tested with water at 70°F (21°C). To determine flow rates for specific coupling configurations use the formula at the right.

$$Q = C_v \sqrt{\frac{\Delta P}{S}}$$

- Q = Flow rate in gallons per minute
- C<sub>v</sub> = Average coefficient across various flow rates (see chart)
- ΔP = Pressure drop across coupling (psi)
- S = Specific gravity of liquid

**C<sub>v</sub> VALUES FOR 1/4" FLOW PLC COUPLINGS**

BODIES	INSERTS	PLC 20004	PLCD 20004	PLC 20006	PLCD 20006	PLC 22004	PLCD 22004	PLC 22006	PLCD 22006	PLC 24004	PLCD 24004	PLC 24006	PLCD 24006	PLC 26004
	PLC10004	.40	.36	1.05	.58	.83	.56	1.40	.82	1.40	.75	1.40	.77	.83
	PLCD10004	.36	.31	.73	.48	.66	.41	.82	.50	.80	.45	.77	.45	.81
	PLC10006	.40	.36	1.05	.60	.83	.56	1.40	.81	1.40	.76	1.40	.76	.83
	PLCD10006	.37	.31	.81	.47	.70	.43	1.02	.51	.98	.46	.99	.48	.98
	PLC12006	.38	.36	.84	.63	.74	.56	1.14	.75	1.14	.70	1.14	.72	.74
	PLCD12006	.38	.33	.78	.49	.68	.44	.84	.49	.81	.43	.82	.44	.81
	PLC16004	.38	.37	.87	.54	.95	.51	1.00	.70	.95	.64	1.00	.66	.95
	PLCD16004	.37	.31	.61	.44	.57	.41	.78	.44	.78	.43	.75	.46	.78
	PLC16006	.38	.37	1.00	.57	.95	.53	1.40	.80	1.40	.71	1.40	.73	1.40
	PLCD16006	.38	.32	.71	.49	.63	.42	.89	.51	.96	.45	.92	.49	.97

# PLC DIMENSIONS

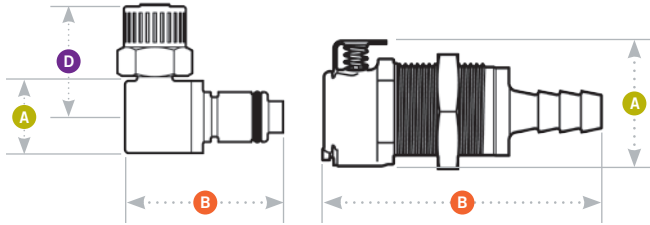

## Panel Dimensions

	PANEL OPENING	PANEL THICKNESS MAX.-MIN.	PANEL NUT HEX	PANEL NUT THREAD
<b>COUPLING BODIES</b>	see drawing	.50 - .05	13/16	11/16-24UNEF
<b>COUPLING INSERTS</b>	see drawing	.30 - .05	13/16	11/16-24UNEF

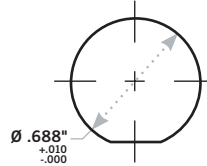

## Coupling Bodies • ACETAL



### TERMINATION IN-LINE PIPE THREAD

### TUBING/THREAD SIZE METRIC EQ.

### NSF PN

### STANDARD PN

**A**

**B**

1/4" NPT		20400	PLC10004 NSF	.90	1.17
1/4" NPT		21000	PLCD10004 NSF	.90	1.17
1/4" BSPT		31600	PLCD10004BSPT NSF	.90	1.15
3/8" NPT		22600	PLC10006 NSF	.90	1.15
3/8" NPT		20600	PLCD10006 NSF	.90	1.15

### PANEL MOUNT FERRULELESS POLYTUBE FITTING, PTF†

3/8" OD, .25" ID	9.5mm OD, 6.4mm ID	29700	PLCD12006 NSF	.88	1.95
------------------	--------------------	-------	---------------	-----	------

### PANEL MOUNT HOSE BARB

1/4" ID	6.4mm ID	28000	PLC16004 NSF	.88	1.95
1/4" ID	6.4mm ID	21100	PLCD16004 NSF	.88	1.95
3/8" ID	9.5mm ID	26700	PLCD16006 NSF	.88	1.95

### PANEL MOUNT JG® PUSH-TO- CONNECT

1/4" OD	6.4mm OD	30100	PLC11004 NSF	.88	1.95
1/4" OD	6.4mm OD	28200	PLCD11004 NSF	.88	1.95

### IN-LINE FERRULELESS POLYTUBE FITTING, PTF†

1/4" OD, .17" ID	6.4mm OD, 4.3mm ID	23200	PLC13004 NSF	.94	1.82
1/4" OD, .17" ID	6.4mm OD, 4.3mm ID	24300	PLCD13004 NSF	.94	1.82
3/8" OD, .25" ID	9.5mm OD, 6.4mm ID	24500	PLCD13006 NSF	.94	1.95

### IN-LINE HOSE BARB

1/4" ID	6.4mm ID	22500	PLC17004 NSF	.94	1.80
1/4" ID	6.4mm ID	22100	PLCD17004 NSF	.94	1.95
3/8" ID	9.5mm ID	20500	PLC17006 NSF	.94	1.80
3/8" ID	9.5mm ID	20800	PLCD17006 NSF	.94	1.95

### IN-LINE JG® PUSH-TO- CONNECT

1/4" OD	6.4mm OD	23000	PLC14004 NSF	.94	1.95
1/4" OD	6.4mm OD	22900	PLCD14004 NSF	.94	1.95
3/8" OD	9.5mm OD	22300	PLCD14006 NSF	.94	2.09

All measurements are in inches (millimeters) unless otherwise noted. Tubing must meet stated inside and outside diameters.  
†NOTE: CPC's Ferruleless Polytube Fitting terminations do not require ferrules to achieve a secure connection, which makes them easier to use and reuse. PTF fittings are designed for semi-rigid tubing, i.e., polyethylene, nylon, polyurethane, etc. NOTE: JG is a registered trademark of John Guest USA, Inc.

## Coupling Inserts • ACETAL



### TERMINATION IN-LINE PIPE THREAD

TUBING/THREAD SIZE	METRIC EQ.	NSF PN	STANDARD PN	A	B	D
1/4" NPT		20400	PLC24004 NSF	.72	1.25	
1/4" NPT		21000	PLCD24004 NSF	.72	1.66	
1/4" BSPT		26100	PLCD24004BSPT	.72	1.66	
3/8" NPT		30400	PLC24006 NSF	.87	1.25	
3/8" NPT		22200	PLCD24006 NSF	.87	1.63	

### PANEL MOUNT FERRULELESS POLYTUBE FITTING, PTF†

1/4" OD, .17" ID	6.4mm OD, 4.3mm ID	30700	PLC40004 NSF	.94	1.78	
1/4" OD, .17" ID	6.4mm OD, 4.3mm ID	26000	PLCD40004 NSF	.94	1.91	
3/8" OD, .25" ID	9.5mm OD, 6.4mm ID	30900	PLCD40006 NSF	.94	2.05	

### PANEL MOUNT HOSE BARB

1/4" ID	6.4mm ID	22400	PLC42004 NSF	.94	1.91	
1/4" ID	6.4mm ID	26600	PLCD42004 NSF	.94	2.05	
3/8" ID	9.5mm ID	31200	PLC42006 NSF	.94	1.91	

### IN-LINE FERRULELESS POLYTUBE FITTING, PTF†

1/4" OD, .17" ID	6.4mm OD, 4.3mm ID	23300	PLC20004 NSF	.72	1.25	
1/4" OD, .17" ID	6.4mm OD, 4.3mm ID	25000	PLCD20004 NSF	.72	1.88	
3/8" OD, .25" ID	9.5mm OD, 6.4mm ID	25200	PLCD20006 NSF	.72	1.82	

### IN-LINE HOSE BARB

1/4" ID	6.4mm ID	22400	PLC22004 NSF	.62	1.35	
1/4" ID	6.4mm ID	21500	PLCD22004 NSF	.62	1.99	
3/8" ID	9.5mm ID	20100	PLC22006 NSF	.62	1.36	
3/8" ID	9.5mm ID	21400	PLCD22006 NSF	.62	1.81	

### IN-LINE JG® PUSH-TO- CONNECT

1/4" OD	6.4mm OD	24700	PLCD29004 NSF	.63	1.95	
3/8" OD	9.5mm OD	24800	PLC29006 NSF	.78	1.51	
3/8" OD	9.5mm OD	24900	PLCD29006 NSF	.78	2.11	

### ELBOW HOSE BARB

3/8" ID	9.5mm ID	20200	PLC23006 NSF	.67	1.25	.90
---------	----------	-------	--------------	-----	------	-----

All measurements are in inches (millimeters) unless otherwise noted. Tubing must meet stated inside and outside diameters.  
†NOTE: CPC's Ferruleless Polytube Fitting terminations do not require ferrules to achieve a secure connection, which makes them easier to use and reuse. PTF fittings are designed for semi-rigid tubing, i.e., polyethylene, nylon, polyurethane, etc. NOTE: JG is a registered trademark of John Guest USA, Inc.

# HFC12 SERIES CONNECTOR



**HFC12 Series couplings** have flow comparable to many 1/2" flow couplings in a 3/8" body size. Compact and lightweight, HFC couplings replace bulky and heavy brass ball-and-sleeve couplings in a wide range of applications. An ergonomic design and a large, shrouded thumb latch pad produce a coupling that is easy to grip and simple to operate. An efficient valve design leads to high flow and low spillage.

## FEATURES

- High efficiency valve
- Ergonomic design
- Polypropylene material
- Compatible

## BENEFITS

- More flow in a compact size
- Easy to grip, simple to operate
- Chemically resistant and gamma sterilizable
- Mates with CPC HFC35 Series couplings

## Specifications ● ● ●

### PRESSURE:

Vacuum to 60 psi, 4.2 bar

### TEMPERATURE:

32°F to 160°F (0°C to 71°C)

### MATERIALS:

- Main components and valves: Polypropylene
- Thumb latch: Polypropylene
- Valve spring (wetted): 316 stainless steel
- External springs: 316 stainless steel
- O-rings: EPDM
- Panel mount gasket: EPDM
- Compression nut, gripper, ferrule: Polypropylene

### COLOR: Gray with dark gray latch

### TUBING SIZES:

3/8" to 3/4" ID, 9.5mm to 19.0mm ID

**WARNING:** Pressure, temperature, chemicals, and operating environment can affect the performance of couplings. It is the customer's responsibility to test the suitability of CPC's products in their own application conditions.

For compression termination specifications: 3/8" OD or 1/2" OD, +0.010/-0.000

*Note: Optional o-ring and spring materials are available, please contact CPC for details.*

⚠ These graphs are intended to give you a general idea of the performance capabilities of each product line. The shaded area of each graph represents the operating range of the product family, i.e., upper and lower values are shown. Therefore, depending on the exact coupling configurations selected, you can reasonably expect values to fall within the shaded area.

HFC12 Air Flow, 100 psig Inlet Pressure

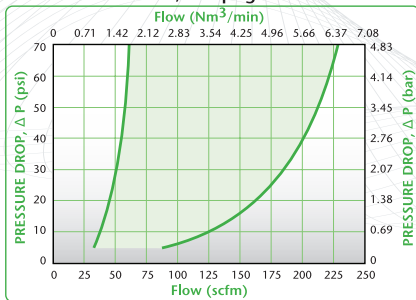

HFC12 Water Flow

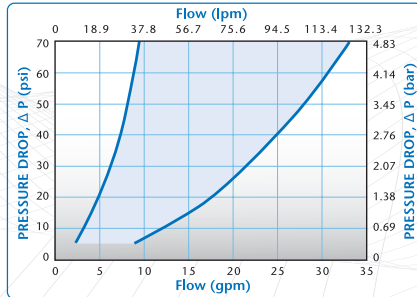

HFC12 Pressure Range

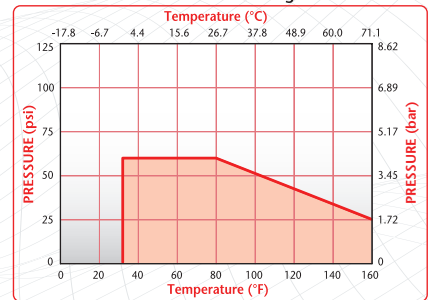

# HFC12 DIMENSIONS

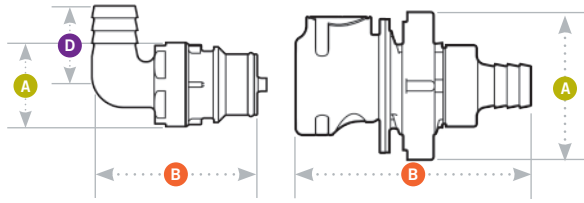

- A = Height/Diameter
- B = Total Length
- D = Elbow Radial Length

## Panel Dimensions

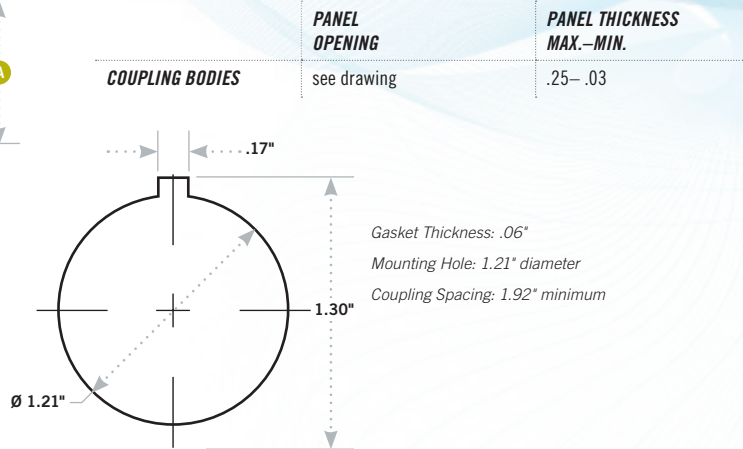

## Coupling Bodies • POLYPROPYLENE



TERMINATION	TUBING/THREAD SIZE	METRIC EQ.	NSF PN	STANDARD PN	A	B
IN-LINE PIPE THREAD	3/8" NPT		63400	HFC10612 NSF	1.44	2.69
	3/8" NPT		63300	HFCD10612 NSF	1.44	2.69
	1/2" NPT		61200	HFC10812 NSF	1.44	2.88
	1/2" NPT		62800	HFCD10812 NSF	1.44	2.88
	3/4" NPT		63500	HFC101212 NSF	1.44	3.07
BULKHEAD PANEL MOUNT HOSE BARB	3/4" NPT		61800	HFC101212 NSF	1.44	3.07
BULKHEAD PANEL MOUNT COMPRESSION	3/8" ID	9.5mm ID	63800	HFC16612 NSF	1.82	2.82
	3/8" ID	9.5mm ID	62600	HFCD16612 NSF	1.82	2.82
	1/2" ID	12.7mm ID	63900	HFC16812 NSF	1.82	2.82
	1/2" ID	12.7mm ID	60300	HFCD16812 NSF	1.82	2.82
	3/4" ID	19.0mm ID	62000	HFCD161212 NSF	1.82	2.94
IN-LINE HOSE BARB	3/8" ID	9.5mm ID	63600	HFC17612 NSF	1.44	2.79
	3/8" ID	9.5mm ID	60600	HFCD17612 NSF	1.44	2.79
	1/2" ID	12.7mm ID	61500	HFC17812 NSF	1.44	2.79
	1/2" ID	12.7mm ID	60700	HFCD17812 NSF	1.44	2.79
	5/8" ID	15.9mm ID	64900	HFCD171012 NSF	1.44	2.94
	3/4" ID	19.0mm ID	63700	HFC171212 NSF	1.44	2.94
	3/4" ID	19.0mm ID	61900	HFCD171212 NSF	1.44	2.94

## Coupling Inserts • POLYPROPYLENE



TERMINATION	TUBING/THREAD SIZE	METRIC EQ.	NSF PN	STANDARD PN	A	B	D
IN-LINE PIPE THREAD	3/8" NPT		62500	HFC24612 NSF	1.16	1.77	
	3/8" NPT		60500	HFCD24612 NSF	1.16	1.89	
	1/2" NPT		64000	HFC24812 NSF	1.16	1.95	
	1/2" NPT		64000	HFCD24812 NSF	1.16	2.07	
	3/4" NPT		62100	HFCD241212 NSF	1.23	2.26	
IN-LINE HOSE BARB	3/8" ID	9.5mm ID	65500	HFC22612 NSF	1.00	1.97	
	3/8" ID	9.5mm ID	62700	HFCD22612 NSF	1.00	2.09	
	1/2" ID	12.7mm ID	61300	HFC22812 NSF	1.00	1.97	
	1/2" ID	12.7mm ID	61400	HFCD22812 NSF	1.00	2.09	
	5/8" ID	15.9mm ID	65100	HFCD221012 NSF	1.00	2.13	
	3/4" ID	19.0mm ID	62200	HFCD221212 NSF	1.00	2.26	
ELBOW HOSE BARB	3/8" ID	9.5mm ID	65200	HFC23612 NSF	1.00	1.93	.93
	3/8" ID	9.5mm ID	61100	HFCD23612 NSF	1.00	2.05	.93
	1/2" ID	12.7mm ID	64400	HFC23812 NSF	1.00	1.97	.93
	1/2" ID	12.7mm ID	61000	HFCD23812 NSF	1.00	2.09	.93
	3/4" ID	19.0mm ID	65400	HFC231212 NSF	1.00	1.95	.93
	3/4" ID	19.0mm ID	65300	HFCD231212 NSF	1.00	2.07	.93

All measurements are in inches (millimeters) unless otherwise noted. Tubing must meet stated inside and outside diameters.

# HFC35 SERIES CONNECTOR



**HFC35 Series polysulfone couplings** are able to withstand demanding applications and feature physical strength, chemical resistance and autoclavability. An ergonomic design and a large, shrouded thumb latch pad produce a coupling that is easy to grip and simple to operate. An efficient valve design leads to high flow and exceptionally low spillage. HFC35 Series couplings are also offered with bulkhead panel mount, garden hose thread and Hastelloy® C spring options.

## FEATURES

- Polysulfone
- High efficiency valve
- Ergonomic design
- Compatible

## BENEFITS

- Physically strong and autoclavable
- More flow and less spillage in a compact size
- Easy to grip, simple to operate
- Mates with HFC12 couplings

## Specifications ● ● ●

### PRESSURE:

Vacuum to 125 psi, 8.6 bar

### TEMPERATURE:

-40°F to 280°F (-40°C to 138°C)

### MATERIALS:

**Main components and valves:** Polysulfone

**Thumb latch:** Polysulfone

**Valve spring:** 316 stainless steel

**External springs:** 316 stainless steel

**O-rings:** EPDM

**Panel mount gasket:** EPDM

**Female GHT gasket:** FDA EPDM

### COLORS:

Natural white, dark gray latch

### TUBING SIZES:

3/8" to 3/4" ID, 9.5mm to 19.0mm ID

**WARNING:** Pressure, temperature, chemicals, and operating environment can affect the performance of couplings. It is the customer's responsibility to test the suitability of CPC products in their own application conditions. Use the graphs on the following page as a guide.

⚠ These graphs are intended to give you a general idea of the performance capabilities of each product line. The shaded area of each graph represents the operating range of the product family, i.e., upper and lower values are shown. Therefore, depending on the exact coupling configurations selected, you can reasonably expect values to fall within the shaded area.

**HFC35/S7 Air Flow, 100 psig Inlet Pressure**

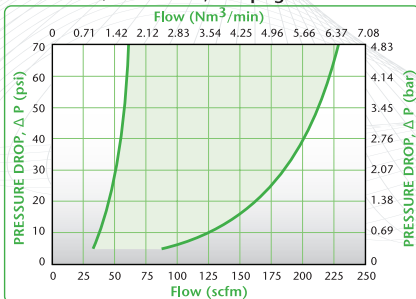

**HFC35/S7 Water Flow**

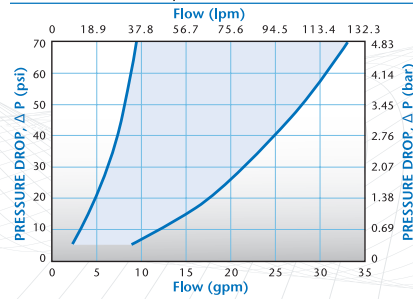

**HFC35/S7 Pressure Range**

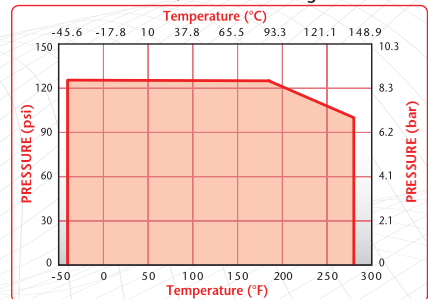

# HFC35 DIMENSIONS

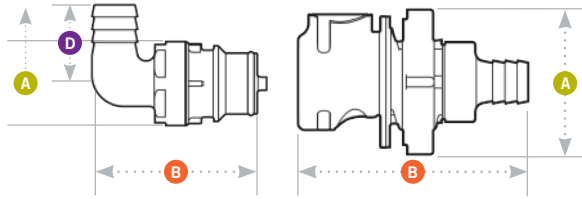

- A = Height/Diameter
- B = Total Length
- D = Elbow Radial Length

## HFC35 Coupling Bodies • POLYSULFONE

TERMINATION	TUBING/THREAD SIZE	METRIC EQ.	NSF PN	STANDARD PN	A	B
IN-LINE PIPE THREAD	3/8" NPT		86300	HFC10635 NSF	1.44	2.73
	3/8" NPT		80100	HFCD10635 NSF	1.44	2.73
	3/8" BSPT		86800	HFCD10635BSPT NSF	1.44	2.73
	1/2" NPT		86400	HFC10835 NSF	1.44	2.88
	1/2" NPT		80200	HFCD10835 NSF	1.44	2.88
	3/4" NPT		87000	HFC101235 NSF	1.44	3.12
	3/4" BSPT		87100	HFCD101235BSPT NSF	1.44	3.12
	3/4" GHT		85900	HFC101235GHT NSF	1.44	2.94
	3/4" GHT		86000	HFCD101235GHT NSF	1.44	2.94
	IN-LINE PIPE THREAD (FEMALE)	3/4" GHT		86100	HFC191235GHT NSF	1.44
3/4" GHT			86200	HFCD191235GHT NSF	1.44	2.70
3/8" ID		9.5mm ID	86500	HFC16635 NSF	1.44	2.82
BULKHEAD PANEL MOUNT HOSE BARB	3/8" ID	9.5mm ID	80300	HFCD16635 NSF	1.44	2.82
	1/2" ID	12.7mm ID	86600	HFC16835 NSF	1.44	2.82
	1/2" ID	12.7mm ID	80400	HFCD16835 NSF	1.44	2.82
IN-LINE HOSE BARB	3/4" ID	19.0mm ID	80500	HFCD161235 NSF	1.44	2.94
	3/8" ID	9.5mm ID	83500	HFC17635 NSF	1.44	2.82
	3/8" ID	9.5mm ID	85600	HFCD17635 NSF	1.44	2.82
	1/2" ID	12.7mm ID	83200	HFC17835 NSF	1.44	2.82
	1/2" ID	12.7mm ID	80700	HFCD17835 NSF	1.44	2.82
	5/8" ID	15.9mm ID	87600	HFCD171035 NSF	1.44	2.94
	3/4" ID	19.0mm ID	82400	HFC171235 NSF	1.44	2.94

## HFC35 Coupling Inserts • POLYSULFONE

TERMINATION	TUBING/THREAD SIZE	METRIC EQ.	NSF PN	STANDARD PN	A	B	D	
IN-LINE PIPE THREAD	3/8" NPT		83600	HFC24635 NSF	1.16	1.82		
	3/8" NPT		81400	HFCD24635 NSF	1.16	1.94		
	3/8" BSPT		87900	HFC24635BSPT NSF	1.16	1.97		
	3/8" BSPT		88000	HFCD24635BSPT NSF	1.16	2.09		
	1/2" NPT		88100	HFC24835 NSF	1.16	1.97		
	1/2" NPT		81500	HFCD24835 NSF	1.16	2.09		
	1/2" BSPT		88200	HFCD24835BSPT NSF	1.16	2.09		
	3/4" NPT		82500	HFC241235 NSF	1.23	2.22		
	IN-LINE PIPE THREAD (FEMALE)	3/4" GHT		82600	HFC261235GHT NSF	1.37	1.79	
		3/4" GHT		89600	HFCD261235GHT NSF	1.37	1.91	
3/4" BSPP			88900	HFC261235BSPP NSF	1.37	1.79		
IN-LINE HOSE BARB	3/8" ID	9.5mm ID	89100	HFC22635 NSF	1.00	1.91		
	3/8" ID	9.5mm ID	80900	HFCD22635 NSF	1.00	2.03		
	1/2" ID	12.7mm ID	83100	HFC22835 NSF	1.00	1.91		
	1/2" ID	12.7mm ID	81000	HFCD22835 NSF	1.00	2.03		
	5/8" ID	15.9mm ID	89300	HFCD221035 NSF	1.00	2.15		
	3/4" ID	19.0mm ID	89400	HFC221235 NSF	1.00	2.03		
ELBOW HOSE BARB	3/8" ID	9.5mm ID	89500	HFC23635 NSF	1.00	1.92	.93	
	3/8" ID	9.5mm ID	81200	HFCD23635 NSF	1.00	2.04	.93	
	1/2" ID	12.7mm ID	83400	HFC23835 NSF	1.00	1.96	.93	
	1/2" ID	12.7mm ID	81300	HFCD23835 NSF	1.00	2.08	.93	

All measurements are in inches (millimeters) unless otherwise noted. Tubing must meet stated inside and outside diameters.

# UDC SERIES CONNECTOR



**The patented 3/8" flow Universal Dispensing Coupler (UDC)** provides a universal connection to a 38mm threaded or snap-in fitment neck. Make instant connections to bulk packaging systems including bag-in-box (BIB), flexible and rigid packaging styles. Automatic flush face valves minimize costly or dangerous spillage. An ergonomic design and a large, shrouded thumb latch pad produce a coupling that is easy to grip and simple to operate.

## FEATURES

- Universal 38mm cap
- Flush face/non-spill valves
- Integral terminations
- Shrouded thumb latch

## BENEFITS

- Fits industry standard fitment necks
- Minimize spillage
- Fewer leak points, shorter assemblies, faster installations
- Protects against accidental disconnects

## Specifications ● ● ●

### PRESSURE:

20" Hg vacuum to 15 psi, 1.0 bar (body only)

### TEMPERATURE:

32°F to 160°F (0°C to 71°C)

### MATERIALS:

**Main body components and valves:**  
Polypropylene

**Springs:**  
Body: 316 stainless steel  
Cap: 302 stainless steel

**UDC caps:** Acetal, polypropylene

**O-rings (food grade):**  
UDC: EPDM, silicone, Buna-N

iUDC: EPDM, silicone

**CIP adapter:** Acetal

**COLOR:** Light gray with dark gray latch

**CLOSURE SIZE:** SP-400 thread/38mm snap-in

### TUBING SIZES:

3/8" to 3/4" ID, 9.5mm to 19.0mm ID

All UDC series products are listed under NSF/ANSI standard 169



# UDC SERIES DIMENSIONS

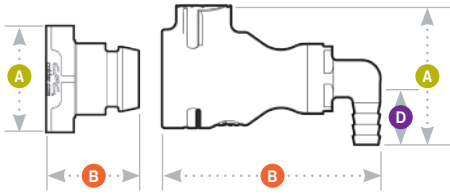

- A** = Height/Diameter
- B** = Total Length
- D** = Elbow Radial Length

## Coupling Bodies • POLYPROPYLENE



TERMINATION	TUBING SIZE	SILICONE O-RING	BUNA-N O-RING	EPDM O-RING	A	B	D
IN-LINE HOSE BARB	3/8" ID	99000	98400	98500	1.73	3.06	
	1/2" ID	95600	97600	95300	1.73	3.06	
	5/8" ID	99100	97900	98100	1.73	3.20	
	3/4" ID	99200	98600	98700	1.73	3.21	
ELBOW HOSE BARB	3/8" ID	99300	97800	99400	1.73	3.25	.93
	1/2" ID	95400	97700	95100	1.73	3.25	.93

## Caps • ACETAL



TERMINATION	DESCRIPTION	SILICONE O-RING	BUNA-N O-RING	EPDM O-RING	A	B
THREAD-ON 38MM VALVED	Without thread seal	95800	96400	97400	1.70	1.47
	With thread seal	95801	96401	97401	1.70	1.47

## • POLYPROPYLENE



TERMINATION	DESCRIPTION	SILICONE O-RING	EPDM O-RING	A	B
SNAP-IN 38MM VALVED		9461300	9500000	1.15	1.77
THREAD-ON 38MM VALVED	With thread seal		9462000	1.70	1.48

*Note: Snap-in closure designed to fit Scholle 900 bag necks.*

## Clean-in-Place (CIP) Adapter • ACETAL



TERMINATION	DESCRIPTION	PART NO.	A	B
IN-LINE	1/2" HB (no o-ring)	96000	1.15	1.56

All measurements are in inches (millimeters) unless otherwise noted. Tubing must meet stated inside and outside diameters. Couplings are pictured with valves unless otherwise noted.

# PUNCTURE SEAL SERIES CONNECTOR

## Specifications ● ● ●

### PRESSURE:

120 psi, 8.3 bar (coupling body)

### TEMPERATURE:

32°F to 160°F (0°C to 71°C)

### MATERIALS:

**Main components and valves:** Polypropylene

**38mm closure:** Polyethylene (LDPE)

**Thumb latch:** Stainless steel

**Valve spring:** 316 stainless steel

**External spring and pin:** Stainless steel

**O-rings:** EPDM

### CLOSURE SIZE: SP-400 38mm

### TUBING SIZES:

1/4" and 3/8" ID, 6.4mm and 9.5mm ID

**The 1/4" flow Puncture Seal** dispensing system provides clean and safe liquid dispensing from bag-in-box (BIB) or other types of flexible packaging. The system consists of a Puncture Seal closure cap and a specially designed quick disconnect coupling body. The closure makes a positive thread or snap-in seal with a 38mm fitment neck. The Puncture Seal coupling body automatically breaks the membrane seal on the closure cap when connected. To switch to a new container, simply depress the CPC thumb latch to disconnect the system and then connect the Puncture Seal coupling body to a fresh container.

## FEATURES

Puncture Seal coupling

Polypropylene and polyethylene materials

Puncture Seal membrane

CPC thumb latch

## BENEFITS

Easily breaks the Puncture Seal membrane

Greater chemical resistance

Eliminates shipping caps and o-rings

One-hand connection and disconnection

## Coupling Bodies • POLYPROPYLENE



**TERMINATION**  
IN-LINE  
HOSE BARB

**TUBING SIZE**  
1/4" ID  
3/8" ID

**METRIC EQ.**  
6.4mm ID  
9.5 mm ID

**STRAIGHT THRU**  
PS1700412  
PS1700612

**SHUTOFF**  
PSD1700412  
PSD1700612

**LENGTH**  
1.95  
1.95

## Closure • POLYETHYLENE

*Note: Snap-in closure designed to fit Scholle 900 bag necks.*



**TERMINATION**  
THREAD-ON  
38MM VALVED

**PART NO.**  
PSC38MM

**LENGTH**  
1.7

**HEIGHT**  
1.12



**SNAP-IN 38MM**  
VALVED

496200

1.88

1.62

## Closure Detail

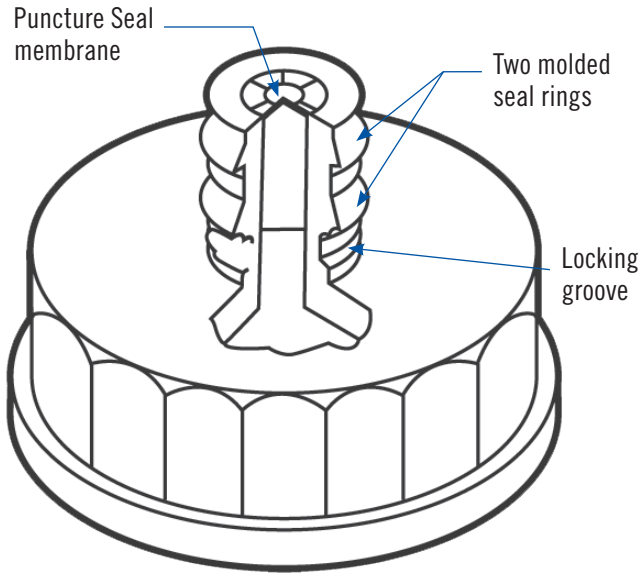

## DID YOU KNOW?

### **CPC'S PUNCTURE SEAL CLOSURES CAN BE USED TO DISPENSE VIRTUALLY ANY LIQUID FROM FLEXIBLE PACKAGES?**

The Puncture Seal makes transporting and dispensing cleaning concentrates, dry cleaning chemicals and soaps cleaner and safer. Printing inks, photo developers and dyeing agents can also be dispensed quickly and easily, without messy drips or spills. The Puncture Seal can also be used with beverage and condiment dispensing systems, just look for the NSF-listed part numbers.

## **NOTES:**

# REGULATORY AND COMPLIANCE

## ***ISO 13485:2003 Certification***

ISO 13485:2003 is recognized by regulators around the world as a good basis for addressing medical device design and manufacturing regulatory requirements. It allows us to enhance product safety by proactively identifying and managing product and project risks. Becoming ISO 13485:2003 certified has allowed us to better control the consistency of manufactured products.

## ***ISO 9001:2008 Certification***

ISO 9001:2008 is a standard which assures consistency of a product ordered by customers. Organizations having ISO 9001:2008 certification have demonstrated compliance to the ISO 9001:2008 requirements by an independent registration authority. CPC's Quality Management System has been approved and certified under the ISO 9001:2008 standard.

## ***Cleanroom Manufacturing***

CPC manufactures certain Life Sciences and Chemical Management product lines in a cleanroom certified by an external testing service to meet or exceed ISO Class 7 (10,000) at 0.5 mm per ISO 14644 and the former Federal Standard 209E. Certification data is available upon request.

## ***FDA and USDA***

The U.S. Food and Drug Administration publishes, through the Code of Federal Regulations, standardized criteria which govern the acceptability of materials used in food contact. The U.S. Department of Agriculture publishes similar standards that mirror FDA criteria. Neither agency approves or disapproves products for particular applications. Most of CPC's products are made using resins that comply with applicable FDA or USDA standards. When necessary, the standard o-ring seals are replaced with specific, recognized materials.

## ***REACH***

REACH is the Regulation for Registration, Evaluation, Authorisation and Restriction of Chemicals. It entered into force on 1st June 2007 to streamline and improve the former legislative framework on chemicals of the European Union (EU). REACH places greater responsibility on industry to manage the risks that chemicals may pose to the health and the environment. CPC publishes a list of CPC products that are compliant with the EU regulation 1907/2006.

## ***Regulation of Hazardous Substances***

The RoHS Directive stands for "the restriction of the use of certain hazardous substances in electrical and electronic equipment." This Directive bans the placing on the EU market of new electrical and electronic equipment containing more than agreed levels of lead, cadmium, mercury, hexavalent chromium, polybrominated biphenyl (PBB) and polybrominated diphenyl ether (PBDE) flame retardants.

## ***NSF***

NSF International, based in Ann Arbor, Michigan, develops and publishes consensual criteria that govern the acceptability of materials and equipment used in food and beverage processing. They also do testing to verify the performance of materials or devices to their published criteria. CPC lists many of its product lines under the criteria of NSF/ANSI Standard 169 (formerly C-2), which governs components used in food and beverage contact applications.

Distributed by:

**COLDER PRODUCTS COMPANY**  
1001 WESTGATE DRIVE  
ST. PAUL, MINNESOTA 55114  
U.S.A.

**PHONE:** +1 651-645-0091  
**FAX:** +1 651-645-5404  
**TOLL FREE:** 800-444-2474  
info@cpcworldwide.com  
cpcworldwide.com

**COLDER PRODUCTS COMPANY GMBH**  
OSTRING 19  
D-63762 GROSSOSTHEIM  
GERMANY

**PHONE:** +49-6026-9973-0  
**FAX:** +49-6026-9973-173

cpcgmbh@cpcworldwide.com  
cpcworldwide.com

**COLDER PRODUCTS COMPANY LIMITED**  
FLAT B, 29/F, WEST GATE TOWER,  
7 WING HONG STREET, CHEUNG SHA WAN  
KOWLOON, HONG KONG

**PHONE:** +852-2987-5272  
**FAX:** +852-2987-2509

asiapacific@cpcworldwide.com  
cpcworldwide.com



**CPC WARRANTY STATEMENT:** CPC (Colder Products Company) warrants its products against defects in workmanship and materials for a period of 12 months from the date of sale by CPC to its initial customer (regardless of any subsequent sale of the products). This warranty is void if the product is misused, altered, tampered with or is installed or used in a manner that is inconsistent with CPC's written recommendations, specifications and/or instructions, or fails to perform due to normal wear and tear. CPC does not warrant the suitability of the product for any particular application. Determining product application suitability is solely the customer's responsibility. CPC is not liable for special, indirect, incidental, consequential or other damages including, but not limited to, loss, damage, personal injury, or any other expense directly or indirectly arising from the use of or inability to use its products either separately or in combination with other products. **ALL OTHER WARRANTIES EXPRESS OR IMPLIED, WHETHER ORAL, WRITTEN OR IN ANY OTHER FORM, INCLUDING BUT NOT LIMITED TO WARRANTIES OF MERCHANTABILITY OR FITNESS FOR A PARTICULAR PURPOSE, ARE EXPRESSLY EXCLUDED.** The sole and exclusive remedy under this warranty is limited, at the option of CPC, to replacement of the defective product or an account credit in the amount of the original selling price. All allegedly defective CPC products must be returned prepaid transportation to CPC, together with information describing the product's application and performance, unless otherwise authorized in writing by CPC.

**CPC PATENT STATEMENT:** CPC takes pride in its innovative quick disconnect coupling and fittings solutions, many of which have been awarded United States and international patents. CPC has a strong tradition of

leadership in the quick disconnect market, and aggressively pursues and protects its proprietary information and intellectual property. In cases where it is practical and has a benefit to its customers, CPC has licensed its proprietary technology. Please contact CPC to discuss your unique needs.

**CPC TRADEMARK STATEMENT:** AseptiQuik<sup>®</sup>, BottleQuik<sup>®</sup>, BreakAway<sup>®</sup>, ChemQuik<sup>®</sup>, DrumQuik<sup>®</sup>, FitQuik<sup>®</sup>, IdentiQuik<sup>®</sup>, Nu-Seal<sup>®</sup>, SnapQuik<sup>®</sup>, Steam-Thru<sup>®</sup>, Softube<sup>®</sup> are registered trademarks with the U.S. Patent & Trademark Office. All other trademarks or service marks are property of their respective owners. **WARNING:** Due to the wide variety of possible fluid media and operating conditions, unintended consequences may result from the use of this product, all of which are beyond the control of CPC. It is the user's responsibility to carefully determine and test for compatibility for use with their application. All such risks shall be assumed by the buyer.

**WARNING:** Due to the wide variety of possible fluid media and operating conditions, unintended consequences may result from the use of this product, all of which are beyond the control of CPC. It is the user's responsibility to carefully determine and test for compatibility for use with their application. All such risks shall be assumed by the buyer.