



WE INSPIRE CONFIDENCE AT
**EVERY POINT
OF CONNECTION.**





SMART FLUID® HANDLING TO TAKE YOU FORWARD, FASTER

CPC (Colder Products Company) has been designing and manufacturing quick disconnect couplings, fittings and connectors since 1978. Our broad range of products are found in thousands of applications across many life sciences, specialty industrial and chemical handling markets. Used in a wide range of products, machinery, devices and processes, CPC's innovative coupling and connection technologies allow flexible tubing to be quickly and safely connected and disconnected. The robust and easy-to-use design of CPC's quick disconnect couplings and fittings provides reliable, secure and leak-free connections for fluid and air management. CPC makes people's lives better by developing innovative high quality products that make fluid handling safe and easy.

WHERE TO BUY

Find your local distributor by visiting cpcworldwide.com or call CPC's Customer Service at 1-800-444-2474 or 651-645-0091. You can also send an email to info@cpcworldwide.com.

QUALITY

CPC meets or exceeds our customers' expectations. Everyone is involved, from our suppliers to our distribution network, and most importantly, our employees. CPC measures and continually improves our standards of product quality, support services and overall customer and employee satisfaction. CPC's Quality System conforms to ISO 9001:2008 and ISO 13485 standards. Our cleanroom is ISO Class 7 certified.

GENERAL PURPOSE PAGES 22-99

24 SMC & SMF1: Twist-to-connect design provides reliable and secure alternative to luer-type connections.

MATERIAL: Acetal, polypropylene, ABS, chrome-plated brass

TUBING ID SIZES: 1/16" to 1/8" (1.6mm to 3.2mm)



28 NS1: Smallest plastic non-spill coupling features enable secure connection and drip-free disconnect.

MATERIAL: Glass-filled polypropylene, PEEK®, polypropylene

TUBING: Microbore to 1/8" (Microbore to 3.2mm)



30 PMC: Features one-hand connection and disconnection and wide range of tubing connection options; easier to use than ball-and-sleeve designs.

MATERIAL: Acetal

TUBING ID SIZES: 1/16" to 1/4" (1.6mm to 6.4mm)



34 PMC12: Offered with a variety of configurations and chemical resistance for demanding applications; gamma sterilizable.

MATERIAL: Polypropylene

TUBING ID SIZES: Microbore to 1/4" (Microbore to 6.4mm)



38 MC: Durable and able to withstand higher pressure and temperature; easy one-hand connection and disconnection.

MATERIAL: Chrome-plated brass

TUBING ID SIZES: 1/8" to 1/4" (3.2mm to 6.4mm)



42 NS212: Twist-to-connect design features non-spill valves designed to provide fast, safe and leak-free fluid line connections.

MATERIAL: Glass-filled polypropylene

TUBING ID SIZES: 1/8" to 1/4" (3.2mm to 6.4mm)



44 PLC®: Widest selection of sizes and configurations offered; resistant to most mild chemical solutions.

MATERIAL: Acetal

TUBING ID SIZES: 1/4" to 3/8" (6.4mm to 9.5mm)



48 DTLD: Unique thumb latch that enables independent connection and simultaneous disconnection of loose tube sets.

MATERIAL: ABS

TUBING ID SIZES: 1/4" to 3/8" (6.4mm to 9.5mm)



50 PLC12: Materials of construction offer broad chemical resistance for demanding applications; gamma sterilizable.

MATERIAL: Polypropylene

TUBING ID SIZES: 1/4" to 3/8" (6.4mm to 9.5mm)



54 LC: Durable and able to withstand higher pressure and temperature; easy one-hand connection and disconnection.

MATERIAL: Chrome-plated brass

TUBING ID SIZES: 1/4" to 3/8" (6.4mm to 9.5mm)



58 APC: Features plastic thumb latch, fewer moving parts and a smooth contoured design to deliver ease-of-use and excellent flow.

MATERIAL: Acetal

TUBING ID SIZES: 1/4" to 3/8" (6.4mm to 9.5mm)



62 DPC: Dual port connection in a contoured design that delivers ease-of-use and excellent flow in a compact size.

MATERIAL: Acetal

TUBING ID SIZES: 1/4" to 3/8" (6.4mm to 9.5mm)



64 EFC12: High-efficiency valve design provides high flow capability; bulkhead panel mount option facilitates tight seals against tank walls and drums.

MATERIAL: Polypropylene

TUBING ID SIZES: 1/4" and 3/8" (6.4mm and 9.5mm)



66 NS4: Non-spill coupling that virtually eliminates spills and minimizes downtime.

MATERIAL: Glass-filled polypropylene, ABS

TUBING ID SIZES: 1/8" to 3/8" (3.2mm to 9.5mm)



LEGEND

NEW PRODUCT

NSF LISTED OPTIONS AVAILABLE

RFID COMPATIBLE

STRAIGHT-THROUGH

SINGLE SHUT-OFF

DOUBLE SHUT-OFF

NON-SPILL

GENERAL PURPOSE PAGES 22-99

68 EVERIST™ LQ2: Liquid cooling non-spill coupling for a secure, reliable connection and dripless disconnect with a nominal flow of 1/8" (3.2 mm).

MATERIAL: Chrome-plated brass

TUBING ID SIZES: 1/4" ID (6.4mm ID)



70 EVERIST™ LQ4: Liquid cooling non-spill coupling for a secure, reliable connection and dripless disconnect with a nominal flow of 1/4" (6.4mm).

MATERIAL: Chrome-plated brass

TUBING ID SIZES: 1/4" to 3/8" (6.4mm to 9.5mm)



72 EVERIST™ LQ6: Liquid cooling non-spill coupling for a secure, reliable connection and dripless disconnect with a nominal flow of 3/8" (9.5 mm).

MATERIAL: Chrome-plated brass

TUBING ID SIZES: 3/8" to 1/2" ID (9.5mm to 12.7mm ID)



74 EVERIST™ LQ8: Liquid cooling non-spill coupling for a secure, reliable connection and dripless disconnect with a nominal flow of 1/2" (12.7 mm).

MATERIAL: Chrome-plated brass

TUBING ID SIZES: 5/8" ID (15.9 mm ID)



76 EVERIST™ PLQ2: Lightweight, reliable, non-spill liquid cooling coupling resistant to galvanic corrosion with a nominal flow of 1/8" (3.2 mm).

MATERIAL: Polyphenylsulfone PPSU

TUBING ID SIZES: 1/4" ID (6.4mm ID)



78 EVERIST™ PLQ4: Lightweight, non-spill liquid cooling coupling resistant to galvanic corrosion with a nominal flow of 1/4" (6.4 mm).

MATERIAL: Polyphenylsulfone PPSU

TUBING ID SIZES: 1/4" to 3/8" (6.4mm to 9.5mm)



80 **EVERIS™ BLQ2:** Ultra-reliable non-spill liquid cooling blind mate coupling for integrated mounting with a nominal flow of 1/8" (3.2 mm).

MATERIAL: Chrome-plated brass

TUBING ID SIZES: 1/4" SAE-4



82 **EVERIS™ BLQ4:** Ultra-reliable non-spill liquid cooling blind mate coupling for integrated mounting with a nominal flow of 1/4" (6.4 mm).

MATERIAL: Chrome-plated brass

TUBING ID SIZES:

Insert: G 1/4, G 3/8, SAE-4, SAE-6

Body: G 1/4, G 3/8, SAE-4, SAE-6, SAE-8



84 **EVERIS™ BLQ6:** Ultra-reliable non-spill liquid cooling blind mate coupling for integrated mounting with a nominal flow of 3/8" (9.5 mm).

MATERIAL: Anodized aluminum

TUBING ID SIZES:

Insert: SAE-6, G 1/2

Body: SAE-6, G 1/2



86 **NS6:** Durable, yet lightweight construction that features non-spill valves and is compatible with many chemicals.

MATERIAL: Glass-filled polypropylene

TUBING ID SIZES: 3/8" and 1/2" (9.5mm and 12.7mm)



88 **NSH:** Pressure-balanced non-spill design with 100% metal-free, spring-free flow path.

MATERIAL: Glass-filled polypropylene

TUBING ID SIZES: 3/8" to 3/4" (9.5mm to 19.0mm)



LEGEND



NEW PRODUCT



NSF LISTED OPTIONS AVAILABLE



RFID COMPATIBLE



STRAIGHT-THROUGH



SINGLE SHUT-OFF



DOUBLE SHUT-OFF



NON-SPILL

GENERAL PURPOSE PAGES 22-99

90 HFC12: Efficient valve design leads to high flow and exceptionally low spillage; shrouded thumb latch is easy to grip and simple to operate.

MATERIAL: Polypropylene

TUBING ID SIZES: 3/8" to 3/4" (9.5mm to 19.0mm)



94 HFC35 & 57: Withstand harsh environments and offered with or without UV-resistant materials to withstand harmful rays without affecting performance.

MATERIAL: Polysulfone (white), UV-resistant polysulfone (black)

TUBING ID SIZES: 3/8" to 3/4" (9.5mm to 19.0mm)



98 FFC35: Features non-valved and unobstructed flow path to increase flow and minimize turbulence.

MATERIAL: Polysulfone

TUBING ID SIZES: 3/4" (19.0mm)



MULTILINE PRODUCTS PAGES 100-109

102 TENTUBE™: Allows connection and disconnection of up to ten lines with one slide latch; tubing orientation ensured by physical keying.

MATERIAL: Nylon, acetal, polypropylene

TUBING ID SIZES: 1/16" to 1/8" (1.6mm to 3.2mm)



104 SIXTUBE™: Snap-in panel mount design and flexibility to connect and disconnect six separate lines with or without valves.

MATERIAL: Acetal, polypropylene

TUBING ID SIZES: 1/16" to 1/8" (1.6mm to 3.2mm)



TWIN TUBE™: One easy-to-use quick disconnect for two separate non-valved flow paths.

MATERIAL: Acetal, ABS

TUBING ID SIZES: 1/16" to 1/8" (1.6mm to 3.2mm)



106 MULTI-MOUNT: Connects three to five lines at once; keyed to prevent mismatched connections.

MATERIAL: Acetal, chrome-plated brass

TUBING ID SIZES: 1/8" to 3/8" (3.2mm to 9.5mm)

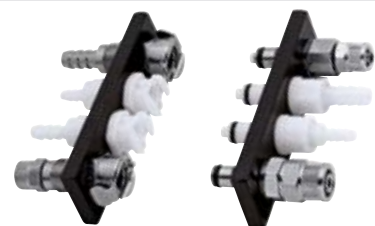

ENHANCED FUNCTIONALITY PAGES 110-119

112 HYBRID CONNECTOR: One integrated connector combining 2 fluid lines with non-spill couplings and 4 electrical lines to simplify the user interface.

MATERIAL: Glass-filled polypropylene



114 MINI HYBRID CONNECTOR: A compact, single connection point combining 1 fluid line with 2 electrical lines with a breakaway mechanism for ease of use.

MATERIAL: Glass-filled polypropylene



116 INTELLIGENT FLUID CONNECTIONS: Redefine what's possible for controlling, protecting and streamlining fluid handling with RFID-enabled couplings.

MATERIAL: Acetal, polypropylene, glass-filled polypropylene



LEGEND

NEW NEW PRODUCT

NSF NSF LISTED OPTIONS AVAILABLE

RFID RFID COMPATIBLE

STRAIGHT-THROUGH

SINGLE SHUT-OFF

DOUBLE SHUT-OFF

NON-SPILL

MEDICAL GRADE PAGES 120-133

122 SMC: Twist-to-connect design manufactured and packaged in a cleanroom.

MATERIAL: Medical-grade polycarbonate

TUBING ID SIZES: 1/16" to 1/8" (1.6mm to 3.2mm)



124 MPC™: Open-format connection for your 3/8" flow applications

MATERIAL: Polycarbonate, polysulfone and silicone

TERMINATIONS: 1/8", 1/4" & 3/8" (3.2mm, 6.4mm, 9.5mm); Sanitary: 3/4" & 1-1/2"



127 BACK-TO-BACK ADAPTERS: Allow end users to connect single-use systems that feature identical connections at the end of their tubing.

MATERIAL: Medical-grade polycarbonate and polysulfone, USP Class VI



128 MPX®: Open-format connection for your 1/2" flow applications

MATERIAL: Polycarbonate, polysulfone, and silicone

TERMINATIONS: 3/8", 1/2" (9.5mm & 12.7mm); Sanitary: 3/4" & 1-1/2"



130 SANITARY SERIES: Attaches directly to 3/4", 1" and 1-1/2" sanitary terminations to provide greater flexibility for integrating components into single-use or hybrid process systems.

MATERIAL: Medical-grade polysulfone, USP Class VI, ADCF

TERMINATIONS: 3/4", 1" and 1-1/2" sanitary



132 SANIQUIK™: Integral sanitary termination attaches to hard-plumbed systems with tri-clover clamps; permits quick and easy connection to single-use bag systems, manifolds or tube sets.

MATERIAL: 316L stainless steel

TERMINATIONS: 3/4" and 1-1/2" sanitary



HIGH PURITY PAGES 134-139

136 CQH: All plastic design for ultra-pure media and high chemical resistance.

MATERIAL: Natural, virgin polypropylene and PVDF

TUBING SIZES: 1/4" to 1/2" flare; 3/8" to 3/4" NPT



138 CQG: Spring-free and metal-free flow path for high flow capacity and non-spill, high purity connections.

MATERIAL: Natural, virgin polypropylene

TUBING SIZES: 3/8" to 3/4" flare; 3/8" to 3/4" NPT



139 CHEMQUIK® DUAL CONTAINMENT SYSTEM: Flare nuts and panel mount fittings that facilitate double containment of critical chemical lines.

MATERIAL: Natural, virgin polypropylene



LEGEND



NEW PRODUCT



NSF LISTED OPTIONS AVAILABLE



RFID COMPATIBLE



STRAIGHT-THROUGH



SINGLE SHUT-OFF



DOUBLE SHUT-OFF



NON-SPILL

DISPENSING PAGES 140-155

142 BQ45GL: Quick disconnect coupling or fitting integrated into a cap designed for 45GL bottles.

MATERIAL: Polyethylene



144 DRUMQUIK® PRO & DRUMQUIK PUR: Closed chemical dispensing system with a reusable coupler and a recyclable dip-tube assembly for chemical extraction from drums, jerry cans and IBCs.

MATERIAL: Food grade, virgin polypropylene and polyethylene

THREAD SIZES:

Drum Inserts: 2" American buttress, BCS 56x4 and 2" NPS (G8), 70mm for BCS 70x5 and BCS70x6

Couplers: 1/2" NPT, 3/4" hose barb and 3/4" BSPP



147 DRUMQUIK® ADAPTORS AND ACCESSORIES: CPC offers many accessories intended for use with DrumQuik® PRO and DrumQuik PUR systems. These include vent check valves, foot valves, fittings and more.

150 DRUMQUIK® 3-PORT UDA: Used with 3/4" male NPT coupling terminations to adapt dip-tubes to standard drum closures for closed system dispensing.

MATERIAL: Food grade, virgin polypropylene

THREAD SIZES: UDA 3-Port: 3/4" male NPT; UDA: none

BOTTLE ADAPTOR KITS: Intended for use on reagent bottles with SP400-38mm threads.

MATERIAL: Natural, virgin polypropylene

THREAD SIZES: SP400-38mm

DRUMQUIK® ASIAN DRUM ADAPTORS, PLUGS AND CAPS



152 UDC: Provides closed connection to bag-in-box packaging with 38mm threaded and snap-in necks.

MATERIAL: Polypropylene and acetal

TUBING ID SIZES: 3/8" to 3/4" (9.5mm to 19.0mm)



154 PUNCTURE SEAL: Provides closed connection to Hedwin Cubitainer® bag-in-box container systems and flexible bags or bottles with SP400 38mm threads.

MATERIAL: Polypropylene (coupling) and polyethylene (cap)

TUBING ID SIZES: 1/4" and 3/8" (6.4mm and 9.5mm)



FITQUIK® FITTINGS, LUERS, AND BLOOD PRESSURE CONNECTORS PAGES 156-163

158 FITQUIK® CONNECTORS: High-quality fittings for leak-free tubing connections. These precision-molded fittings are designed to reduce tubing leak points in applications such as medical devices, analytical instrumentation or air-driven equipment.



ACCESSORIES PAGES 164-169

166 ACCESSORIES: Offering includes a variety of ancillary components from fittings and luers to PTF nuts and dust caps.

168 STERILIZATION AND DISINFECTANT METHODS

169 REGULATORY AND COMPLIANCE



LEGEND

 **NEW** NEW PRODUCT

 **NSF** NSF LISTED OPTIONS AVAILABLE

 **RFID** RFID COMPATIBLE

 **STRAIGHT-THROUGH**

 **SINGLE SHUT-OFF**

 **DOUBLE SHUT-OFF**

 **NON-SPILL**

OUR CAPABILITIES

CPC's engineered, custom solutions improve the overall functionality and design of the equipment and processes in which they are used. Special product features include precise hose barbs for superior grip, built-in shutoff valves to prevent product spills and an easy-to-use, push-button thumb latch for quick disconnecting.

CPC's patented Hybrid Connector technology platform eliminates misconnections by integrating electrical, fluid and gas lines into a single connection point. RFID-enabled IdentiQuik® couplings redefine what's possible for controlling, protecting and streamlining fluid handling processes. IdentiQuik technology allows the robust transfer of fluid and information to identify device type or connected media, verify line connection accuracy or capture fluid and product data. Specific applications for CPC connection technologies include:

THERMAL MANAGEMENT

CPC designs and manufactures Everis™ quick disconnect couplings (QDs) to specifically meet the demands for high performance in liquid cooling. Everis quick disconnect couplings from CPC are designed to optimize flow while offering excellent durability and ease of use; they are compatible with a variety of coolants. Most importantly, Everis quick disconnects' patented non-spill design are ideal for long-term, connected use. Reliability is needed for sensitive and critical liquid cooling of electronics environments such as found in high performance computing, EV charging, data centers, 5G, and edge computing as well as medical electronics.

LIFE SCIENCES

CPC's products are used across a broad range of medical devices and equipment, including surgical, dialysis, blood pressure monitoring, patient therapy devices, and in vitro diagnostics. A de facto standard in several applications, CPC connectors prevent misconnections and increase the ease of use of medical devices. Medical device OEMs around the world choose CPC connectors because of our proven performance in the operating room, the life science lab and the home healthcare setting.

SPECIALTY INDUSTRIAL

CPC's couplings and fittings are installed in thousands of product applications. Our broad offering appeals to product manufacturers in a wide range of industrial and consumer-based markets, including analytical instrumentation, printing and ink management, engine systems, biohazard detection equipment, electronic cooling and portable hydration systems.

CHEMICAL HANDLING

CPC's extensive options for chemically resistant quick disconnect fittings, closures, couplings and chemical dispensing systems provide non-spill operation chemical management environments. Applications include semiconductor, LCD, solar, pharmaceutical manufacturing and chemical management, pump, filter and de-ionized water connections, cleaning, soap and detergent dispensing, bulk ink management and consumer-based applications.

Closed-loop dispensing systems enable fast, easy and economic chemical extraction from drums, IBCs and jerry cans.

ENGINEERED SOLUTIONS WORLDWIDE

CPC innovates on the leading edge of what is possible and collaborates to develop the best solution for each customer. Many of CPC's standard couplings and fittings began as custom engineered solutions that found broader use in applicable markets. CPC delivers unmatched product design and quality with local engineering support in the United States, Europe and Asia. To date, CPC has produced over 12,500 custom and standard products to meet the fluid handling challenges of various industries worldwide.



HOW TO CHOOSE THE RIGHT CONNECTOR

INTRODUCTION

With so many connection options, it can often be an overwhelming task to decide which connector is best suited for an application. By understanding your application requirements and selecting the correct connection type, you will have better performance and sealing results.

ASSESSING THE APPLICATION

Understanding your application is the key to selecting the proper connection. Use the following guide to simplify your selection.

FLOW	What is your required flow and pressure drop? Be sure to allow for the effect of shutoff valves and tubing connections on your calculations.
TUBING	What size tubing, both inner and outer diameter, are you using?
MEDIA	The viscosity and corrosiveness of the fluid going through the connection need to be considered. Make sure the media is chemically compatible with ALL coupling materials - including the seals, o-rings and springs. Double-check media compatibility.
TEMPERATURE	Know your minimum and maximum temperature range. Standard temperature ranges are from -40° to 200° F (-40° to 93° C) depending on connection material.
PRESSURE	What is the maximum pressure your connection will need to withstand during operation? Quick disconnects rated to 250 psi (17 bar) will handle most low pressure applications.
TUBING CONNECTIONS	Type: Hose barb, compression fittings and push-to-connect are the most common termination styles. Size: You will need to know ID for hose barbs, OD for push-in-fittings and tube ID and OD for compression.
SHUTOFF OPTIONS	Do you need automatic shutoff valves? Shutoff options are single, double and non-spill.
MOUNTING OPTIONS	How is the connection going to be configured into your application? Common mounting options include pipe thread, panel mount, in-line or elbow.
SPECIAL REQUIREMENTS	Sterilization, NSF listed, USP Class VI approved materials, special packaging, color coding, keying, etc.



Global Distribution

Find your local distributor by visiting cpcworldwide.com/
Contact us or call CPC's Customer Service at 1-800-444-2474 or 651-645-0091.

Quality

Quality is a key component of CPC's success. We are ISO 9001:2008 and ISO 13485:2003 certified and our cleanroom is ISO Class 7 certified.

VISIT US ONLINE FOR INTERACTIVE WEB TOOLS

CPCWORLDWIDE.COM



CPCWORLDWIDE.COM/DRUMQUIK

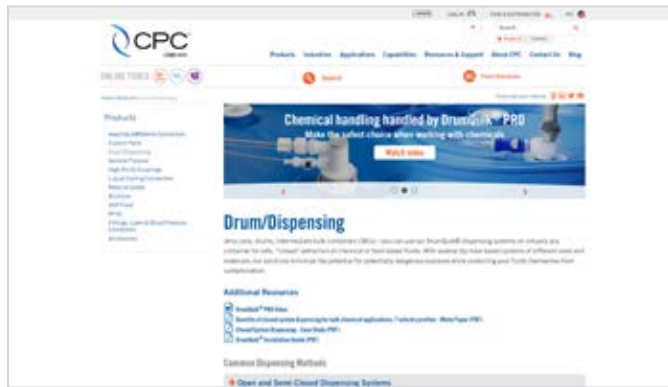

CPCWORLDWIDE.COM/FITQUIK



CPCWORLDWIDE.COM/MEDICAL



FIND A DISTRIBUTOR



<https://www.cpcworldwide.com/Contact-Us/Find-a-Distributor>

ALSO ON THE WEB

- PRODUCT SPECIFIER
- CHEMICAL COMPATIBILITY
- ASK OUR ENGINEERS
- CAD MODELS
- WATCH PRODUCT VIDEOS

MATERIAL OPTIONS

The type of media flowing through a connection can affect the strength, surface appearance, color and performance of the connection. Here are some guidelines for the different types of material.

THERMOPLASTICS

ABS	Economical, medical-grade thermoplastic that withstands gamma and e-beam sterilization. It is commonly used in medical devices. ABS is an amorphous material with good physical properties and good impact resistance.
ACETAL	Strong, lightweight and economical material used for a wide variety of chemical and mechanical components. Acetal offers high strength and rigidity over a broad temperature range, low wear, toughness and resistance to repeated use.
POLYAMIDE <i>(Nylon)</i>	Very resistant to wear and abrasion, good mechanical properties even at elevated temperatures, low permeability to gases and good chemical resistance.
PEEK® <i>(Polyetheretherketone)</i>	Highly temperature resistant, engineered thermoplastic with excellent chemical and fatigue resistance. It exhibits superior mechanical and electrical properties.
POLYCARBONATE	Resistant to some chemicals, withstands sterilization and is typically transparent. It is commonly used in medical devices and offers impact resistance, outstanding dimensional stability and good optical properties.
POLYETHYLENE	Low-cost, chemically resistant thermoplastic. It is opaque and has good impact resistance.
POLYPROPYLENE	Excellent general purpose resin that is highly resistant to chemical attack from solvents and chemicals in harsh environments. In general, polypropylene is resistant to environmental stress cracking and it can be exposed to challenging environments.
POLYSULFONE	Rigid material with excellent strength, good chemical resistance; withstands repeated sterilization and higher temperatures than other thermoplastics. Its high hydrolytic stability allows its use in medical applications requiring repeated high temperature autoclave and steam sterilization.
PPS <i>(Polyphenylene Sulfide)</i>	Broadest resistance to chemicals as an advanced engineering plastic.
PPSU <i>(Polyphenylsulfone)</i>	Polyphenylsulfone is heat and chemically-resistant with high thermal and hydrolytic stability. The material is inherently flame retardant and is UL94 VO-rated.

FLUOROPOLYMERS

PTFE	Chemically resistant to all chemicals and solvents with the exception of some molten metals, molten sodium hydroxide, elemental fluorine and certain fluorinating agents. PTFE offers chemical resistance and stability at high temperature.
PVDF	Tough engineering thermoplastic with a balance of physical and chemical properties that qualifies it for high performance in a wide range of applications. It is mechanically strong and tough, has good ductility and has a broad, useful temperature range.



ALLOYS

ALUMINUM

Lightweight metal with an available hard anodized finish for durability. Aluminum is non-toxic, non-magnetic, non-sparking and is known for its high strength to weight ratio.

NICKEL-CHROME PLATED BRASS

Rugged metallic material with an attractive appearance, chrome-plated brass is excellent for higher pressure and temperature.

DIE-CAST ZINC

Durable and lightweight (about 20% less than comparable brass) material that withstands high pressure and temperature.

STAINLESS STEEL

Offers excellent corrosion resistance and is often used for connector components such as valve springs.

O-RING SELECTION

Selecting the correct o-ring is essential to your application. One o-ring can offer you better chemical resistance, another can offer better heat resistance, a third can offer cold flexibility. Here are some guidelines for the different types of o-rings.

BUNA-N

The most common o-ring material is Buna-N due to its solvent, oil and water resistance. It has a temperature range of -40° to 250° F (-40° to 121° C).

EPDM

Ethylene-propylene-diene rubber is a chemically-resistant family of compounds. CPC uses high quality peroxide-cured EPDMs that provide exceptional resistance to chemicals when using a wide range of temperatures.

FFKM

(*Chemraz®*, *Simriz®*, *Kalrez®*)

Broadest range of chemical resistance of any elastomeric material, combining the resilience and sealing force of an elastomer with chemical resistance approaching that of PTFE.

FKM

Well-known for its outstanding resistance to heat, oxidation, weathering and ozone. The temperature range is -15° to 400° F (-26° to 204° C).

PFA & FEP ENCAPSULATED SEALS

Encapsulated seals combine the resiliency of the elastomer with the superior chemical resistance of the fluoropolymer to achieve a seal that is lower cost than a pure fluoroelastomer FFKM seal.

SILICONE

Seals have good temperature resistance. The temperature range is -70°F to 400°F (-57°C to 204°C) with special compounds that can reach up to 450°F (232°C). Silicone can also be supplied with Class VI requirements for life sciences applications.

THERMOPLASTIC ELASTOMERS

TPE

Thermoplastic Elastomer (TPE) is a blend of additives and copolymers in a special formulation that forms extremely durable bonds to a substrate, while offering the traditional properties of soft-touch overmold.

TPV

Thermoplastic Vulcanizate (TPV) is an alloy of polypropylene thermoplastic and fully vulcanized EPDM rubber. TPV is typically resistant to water, acids and bases.



THE RIGHT NUMBER OF BARBS

Many things work together to determine the quality of the connection between a hose barb and the tubing it connects. The sharpness of the barb, surface finish and the barb angle all contribute to the overall quality of the connection. Failing to optimize these technical aspects will result in a poor connection, regardless of the number of hose barbs used.

CPC offers a variety of hose barb styles and connection options for tubing ranging from 1/16" to 1" ID.



Innovative Fluid Management Solutions: CPC Quick Disconnect Fittings

Discover the benefits of integrating CPC's fluid connectors, couplings and fittings. With engineer-to-engineer collaboration, CPC works with clients in a wide range of industries early in their design process to create custom quick connect and disconnect fittings that are unique to their fluid management systems.



CUSTOM PROJECT CAPABILITIES

We pride ourselves on creating inventive solutions for design engineers' unique challenges. We understand that every project has its own timing, budget and difficulties. Drawing upon our skills for innovation, we can find the right solution for you from our existing products or engineer a custom-made connector.

Count on us to deliver the fluid handling expertise and experience essential for your special unique project requirements.

INNOVATION AND EXPERTISE PUT TO WORK FOR YOU

CPC believes innovation is a result of collaboration. Our engineers, working closely with your team, help solve challenging design or technical issues and help you get to market faster. Partner with a company that has over 40 years' experience working with thousands of fluid management scenarios. Our highly knowledgeable experts help identify your challenges and optimize connector solutions for you to consider. Trust us to create reliable connections for your fluid management system and much more.

Collaborating early in your design process empowers you to find the perfect connector for your needs and a partner for the long haul.

WHEN TO CONSIDER A CUSTOM PROJECT

- New design would add value to product making it easier to use and more reliable
- The specification cannot be met by an existing standard CPC product
- The project has unique requirements such as budget or scheduling challenges

Our Custom Engineering team supports a wide range of customer needs—from simple and minor modifications to fully customized systems. We're ready to meet your project fluid handling requirements. Talk to a CPC distributor or click on the QR Code to view our video on the benefits of partnering with us for your custom solution.

MINOR MODIFICATIONS



O-rings



Aesthetic



Tube Connections



Springs

Enhanced Functionality



Materials

AESTHETICS

Aesthetics often play a key role in the acceptance of a product and give an overall perception of quality. Even the smallest components may have an effect on the aesthetics of your design. Turn to our team of engineering experts to help you optimize your connection interface design to match the specific aesthetics of your products.

APPLICATION USE CASES

Color Customization

Working with our Custom Engineering team, a wide range of customers have customized their fluid connectors and couplings by matching colors to their user interface panel, their equipment colors or even their company colors. Additionally, color coding helps avoid confusion between fluids when connecting, making it easy to identify the fluids lines.

In one example, a maker of hydration solutions needed a connector that was leak free and matched the colors of their personal hydration system. Collaborating with the customer's design engineers, we developed a blue connector with a yellow latch that complemented the product's color scheme and provided the user with a simple, leak-free way to stay hydrated while outdoors.

Visual Keying

Visual keying helps prevent misconnections and is especially important where there are many similar connectors as part of the user interface. While primarily used to eliminate misconnections, visual keying may also be used to avoid damage to connectors or equipment caused by jamming the connector into the wrong socket. Collaborate with our custom engineers to add the color coding you require to help eliminate misconnections and increase ease-of-use for the user.

Working together with an electronic equipment manufacturer, CPC Custom Engineering engineered a quick disconnect coupling that is color coded red or blue to help technicians identify which part of the system's cooling loop is associated with the connector. Color coding helps indicate the temperature of the coolant in the specific area of the liquid cooling system.



ENGINEERED SOLUTIONS



Multi-tube Connections



Electronic Integration

RFID Integration



Engineered Systems



ENHANCED FUNCTIONALITY

Fluid transfer connection technology expertise adds value to your products by:

- Making your equipment, devices or instruments easier to use
- Delivering enhanced reliability
- Increasing design modularity
- Enhancing serviceability
- Providing an overall cleaner, faster and smarter connection

If you can't find the perfect solution from one of our thousands of standard products or you'd like to simply off-load the connector portion of your project to focus on your core technologies, CPC's Custom Engineering provides the expertise and experience in fluid connection technology to assist you in finding the best options for your requirements.

APPLICATION USE CASES

Household Cleaning Product: floor mop

A manufacturing company was looking to simplify the manufacturing assembly process of its floor mop with an attached cleaning fluid container. With multiple manual steps, including drilling a hole in the container cap, the manufacturing process was taking too much time to get the fluid connector onto the container. The manual steps were causing inconsistencies in assembly, increased number of products being rejected due to quality issues (especially fluid leakage) and added labor and material costs.

Working with the manufacturer's design team, our engineers developed a drop-in replacement that integrated a lightweight, chemically resistant coupling into the cap of the cleaning fluid container—eliminating the manual steps. The integrated coupling makes it easier to manufacture the mop and improves overall useability and serviceability. Most importantly, the integrated solution saves costs with fewer scrapped parts and less labor hours with shortened assembly times.

COMPONENT INTEGRATION: PRINTER FILTRATION SYSTEM

To make connections easier to use and provide a cleaner, more flexible design, many customers collaborate with CPC to develop connection solutions that incorporate functions beyond a standard fluid or air connection. Examples of these types of custom connections include integrating sensors, electrical lines, filtration components, and other types of functions. Our Custom Engineering team of materials scientists, design engineers and application engineers work side-by-side with your engineering team to get the right connector technology for your unique requirements.

For instance, one large-format printer manufacturer needed to make changing the filter on its printers easier for its users and technicians while preventing ink from spilling when the filter was changed. Our Custom Engineering team, in conjunction with the manufacturer's design team, developed a disk filter with an integrated, chemically compatible coupling that simplified the filter changing process. Matter of fact, with the coupling's easy-to-use thumb latch for connection/disconnection, there are virtually no ink spills when the filter is changed.

ELECTRONIC INTEGRATION

Equipment or devices with multiple connection interfaces are often confusing and time-consuming. Eliminate user confusion with one stress-free connection. Our team of engineering experts helps you optimize your primary user interface design with one integrated fluid and electrical connector specifically engineered to your performance requirements.

If your design engineers need to specify, test and validate dozens of individual components to determine how to connect multiple lines to your devices, our custom-engineered connectors with electrical integration are the answer. Collaborating with our team to create a hybrid connector saves time and money with only one product to purchase and inventory—instead of a variety of individual components.

APPLICATION USE CASES

Aesthetic therapy devices: cosmetic laser devices for laser hair removal, photofacial skin rejuvenation, tattoo removal, etc.

An aesthetician uses a handheld device with a liquid loop to cool the handheld, electrical lines for power and potentially video lines. CPC engineers, working with the manufacturers' design team, developed a specific hybrid connector with integrated connections for these individual lines. The hybrid connector makes it easier for the user to change handhelds depending on the type of procedure and improves the overall design of the equipment.

IVD instruments: flow cytometry equipment, routinely used in the diagnosis of health disorders especially blood cancers

The flow cytometer uses large volumes of reagents and requires secure connections to ensure proper reagent delivery and waste collection. A custom engineered hybrid connector on the end of the cytometer's umbilical line enables a single connection for monitoring fluid levels and transferring sheath or waste fluid. Containing a built-in level sensor and electrical connection, the hybrid connector alerts the cytometer when the buffer and rinse media are low and need to be replaced. CPC's hybrid coupling provides quick and easy connection and disconnection to replace consumable fluids while at the same time reducing exposure to potential biohazardous spills on waste containers.





Optimize operational efficiency and productivity with a cleaner, faster and safer way to make a connection

CPC general purpose connectors are versatile and engineered to fit a broad range of fluid handling applications. These multifunctional couplings offer a diverse set of options including terminations, configurations, sizes and materials. With decades of experience in delivering connection technology, CPC general purpose couplings and connectors have features that meet the precise needs of demanding users around the globe, including:

- Precise hose barbs to improve the seal and grip for various grades of tubing
- Thumb latch with an audible "CPC Click" for connection assurance
- Non-spill technology to enhance equipment modularity

Count on CPC general purpose connectors to get the job done. No matter what your application requires, every CPC coupling and connector is uniquely engineered to meet your needs.

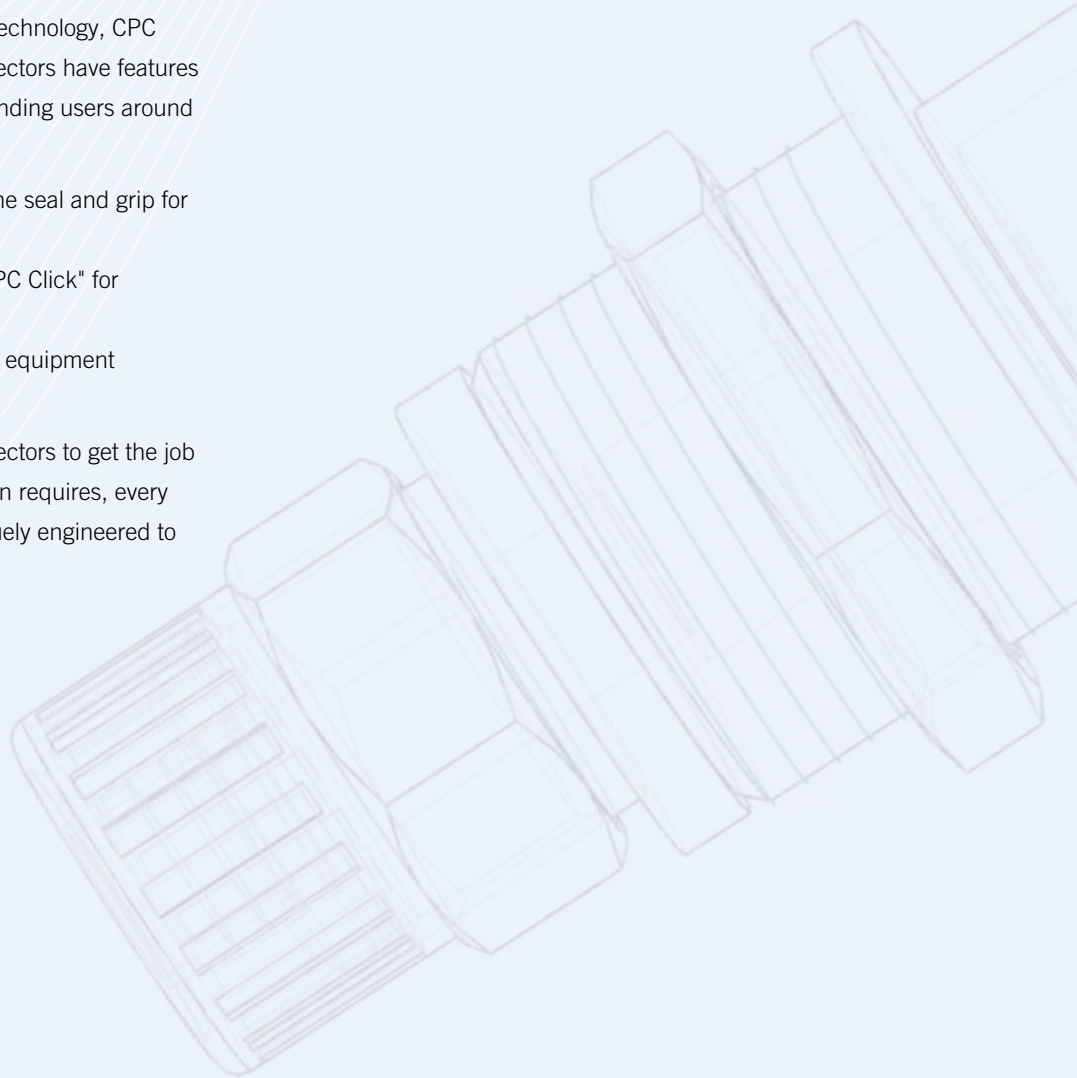

GENERAL PURPOSE
Couplings and Connectors

SMC SERIES CONNECTOR

The SMC and SMF1 are among CPC's smallest couplings. These twist-to-connect couplings provide a reliable and more secure alternative to luer-type connections. They also allow for the tubing to rotate freely when connected. This important feature prevents both kinked tubing and accidental disconnection during use.



SPECIFICATIONS

PRESSURE:

Vacuum to 100 psi, 6.9 bar

TEMPERATURE:

Acetal, Chrome-Plated Brass:

-40°F to 180°F (-40°C to 82°C)

Polypropylene:

32°F to 180°F (0°C to 82°C)

ABS: -40°F to 160°F (-40°C to 71°C)

MATERIALS:

Main Components: ABS, acetal, polypropylene, chrome-plated brass, stainless steel

Locking sleeves: Acetal

Valves: Acetal

Valve spring: 316 stainless steel

O-rings: Buna-N with acetal or chrome-plated brass, EPDM with polypropylene

COLOR:

Main components: Natural white (acetal and ABS), almond (polypropylene), chrome and black (acetal)

TUBING SIZES:

1/16" to 1/8" ID, 1.6mm to 3.2mm and 5.0mm

WARNING: Pressure, temperature, chemicals, and operating environment can affect the performance of couplings. It is the customer's responsibility to test the suitability of CPC products in their own application conditions.



cpcworldwide.com/SMC

FEATURES

Twist to connect



Prevents accidental disconnects

Free coupling rotation



Eliminates kinked tubing

Quarter turn latch clicks when connected



Prevents damage due to over torquing

BENEFITS

SMC WATER FLOW

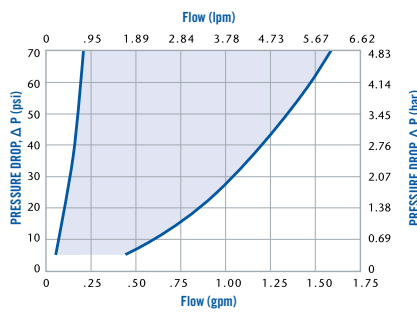

SMC AIR FLOW • 100 psig inlet pressure

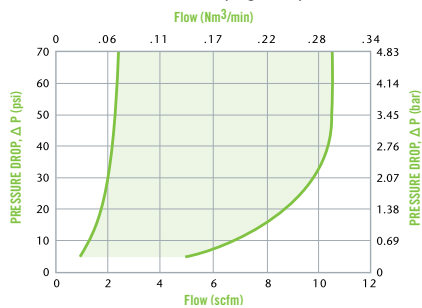

DID YOU KNOW

Polycarbonate SMC products manufactured in CPC's cleanroom are also available.

← These graphs are intended to give you a general idea of the performance capabilities of each product line. The shaded area of each graph represents the operating range of the product family, i.e., upper and lower values are shown. Therefore, depending on the exact coupling configurations selected, you can reasonably expect values to fall within the shaded area.



ASK AN ENGINEER

When you have questions, our team of expert engineers has answers. Click on the QR Code to get connected.



LIQUID FLOW RATE INFORMATION FOR COUPLINGS

The chart below shows the flow rate for CPC couplings. Each coupling was tested with water at 70°F (21°C). To determine flow rates for specific coupling configurations use the formula below.

C_v VALUES

INSERTS

	SMM01	SMM02
BODIES		
SMF01	0.03	0.03
SMFD01	0.03	0.03
SMF02	0.03	0.19
SMFD02	0.03	0.08
SMPT02	0.03	0.19
SMFD02	0.03	0.08

$$Q = C_v \sqrt{\frac{\Delta P}{S}}$$

- Q = Flow rate in gallons per minute
- C_v = Average coefficient across various flow rates (see chart)
- ΔP = Pressure drop across coupling (psi)
- S = Specific gravity of liquid

SMC SERIES DIMENSIONS

COUPLING BODIES - Acetal



TERMINATION	TUBING/THREAD SIZE	METRIC EQ	STRAIGHT THRU	SHUTOFF	A	B	C
IN-LINE PIPE THREAD	1/8" NPT		SMPT02	SMPTD02	0.51 (13)	0.86 (21.8)	7/16 (11.1)
	1/8" NPT		SMPT02BLK	SMPTD02BLK	0.51 (13)	0.86 (21.8)	7/16 (11.1)
IN-LINE HOSE BARB	1/16" ID	1.6mm ID	SMF01	SMFD01	0.48 (12.2)	0.75/90 (19.1/22.9)	
	—	1.6mm ID	SMF01MBLK	SMFD01MBLK	0.48 (12.2)	0.75/90 (19.1/22.9)	
	—	3.0mm ID	SMFM3	SMFDM3	0.48 (12.2)	1 (25.4)	
	1/8" ID	3.0mm ID	SMFM3MBLK	SMFDM3MBLK	0.48 (12.2)	1 (25.4)	
	1/8" ID	3.2mm ID	SMF02	SMFD02	0.48 (12.2)	0.90 (22.9)	
	1/8" ID	3.2mm ID	SMF02MBLK	SMFD02MBLK	0.48 (12.2)	0.90 (22.9)	
PANEL MOUNT HOSE BARB	1/16" ID	1.6mm ID	SMFPM01	SMFPM01	0.58 (14.7)	0.75/90 (19.1/22.9)	1/2 (12.7)
	1/16" ID	1.6mm ID	SMFPM01BLK	SMFPM01BLK	0.58 (14.7)	0.75/90 (19.1/22.9)	1/2 (12.7)
	—	3.0mm ID	SMFPM3	SMFPM3	0.58 (14.7)	1 (25.4)	1/2 (12.7)
	—	3.0mm ID	SMFPM3BLK	SMFPM3BLK	0.58 (14.7)	1 (25.4)	1/2 (12.7)
	1/8" ID	3.2mm ID	SMFPM02	SMFPM02	0.58 (14.7)	0.90 (22.9)	1/2 (12.7)
	1/8" ID	3.2mm ID	SMFPM02BLK	SMFPM02BLK	0.58 (14.7)	0.90 (22.9)	1/2 (12.7)

COUPLING BODIES - Polypropylene



TERMINATION	TUBING/THREAD SIZE	STRAIGHT THRU	SHUTOFF	A	B	C
IN-LINE PIPE THREAD	1/8" NPT		SMPT0212	0.51 (13)	0.86 (21.84)	7/16 (11.1)
IN-LINE HOSE BARB (ACETAL LOCKING SLEEVE)	1/16" ID	1.6mm ID	SMF0112	0.48 (12.2)	0.75/90 (19.1/22.9)	
	1/8" ID	3.2mm ID	SMF0212	0.48 (12.2)	0.90 (22.9)	
PANEL MOUNT HOSE BARB (ACETAL LOCKING SLEEVE)	1/16" ID	1.6mm ID	SMFPM0112	0.58 (14.7)	0.75/90 (19.1/22.9)	1/2 (12.7)
	1/8" ID	3.2mm ID	SMFPM0212	0.58 (14.7)	0.90 (22.9)	1/2 (12.7)

SMF1 DISPOSABLE BODIES - ABS



TERMINATION	TUBING/THREAD SIZE	STRAIGHT THRU	SHUTOFF	A	B	C
IN-LINE HOSE BARB	1/8" ID	3.2mm ID	SMF10297	0.38 (9.7)	0.82 (20.8)	
	1/8" ID	3.2mm ID	SMF10297MBLK	0.42 (10.7)	0.82 (20.8)	

All measurements are in inches (millimeters) unless otherwise noted. Tubing must meet stated inside and outside diameters. MBLK = molded black material. BLK = dyed black material.

PRODUCT DIMENSIONS

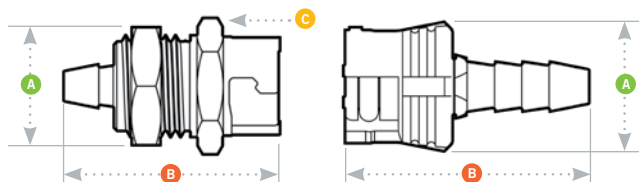

A = Height/Diameter B = Total Length C = Hex Size on Main Component

PANEL DIMENSIONS

	PANEL OPENING	PANEL THICKNESS MAX. – MIN.	PANEL NUT HEX	PANEL NUT THREAD
COUPLING BODIES	7/16	0.21 – 0.03	1/2	7/16-24UNF
COUPLING INSERTS	7/16	0.21 – 0.03	1/2	7/16-24UNF

COUPLING INSERTS - Acetal



TERMINATION	TUBING/THREAD SIZE	METRIC EQ	STRAIGHT THRU	A	B
IN-LINE HOSE BARB	1/16" ID	1.6mm ID	SMM01	0.48 (12.2)	0.75 (19.1)
	1/16" ID	1.6mm ID	SMM01MBLK	0.48 (12.2)	0.75 (19.1)
	—	3.0mm ID	SMMM3	0.48 (12.2)	0.8 (20.3)
	1/8" ID	3.2mm ID	SMM02	0.48 (12.2)	0.8 (20.3)
	1/8" ID	3.2mm ID	SMM02MBLK	0.48 (12.2)	0.9 (22.9)
	—	4.0mm ID	SMMM4	0.48 (12.2)	0.9 (22.9)
	—	5.0mm ID	SMMM5	0.48 (12.2)	1.02 (25.9)
	—	5.0mm ID	SMMM5MBLK	0.48 (12.2)	1.02 (25.9)
PANEL MOUNT HOSE BARB	1/16" ID	1.6mm ID	SMMPM01	0.5 (12.7)	0.75 (19.1)
	1/16" ID	1.6mm ID	SMMPM01BLK	0.5 (12.7)	0.75 (19.1)
	—	3.0mm ID	SMMPM3	0.5 (12.7)	0.8 (20.3)
	1/8" ID	3.2mm ID	SMMPM02	0.5 (12.7)	0.9 (22.9)
	1/8" ID	3.2mm ID	SMMPM02BLK	0.5 (12.7)	0.9 (22.9)

COUPLING INSERTS - Polypropylene



TERMINATION	TUBING/THREAD SIZE	METRIC EQ	STRAIGHT THRU	A	B
IN-LINE HOSE BARB (ACETAL LOCKING SLEEVE)	1/16" ID	1.6mm ID	SMM0112	0.48 (12.19)	0.75 (19.1)
	1/8" ID	3.2mm ID	SMM0212	0.48 (12.19)	0.9 (22.9)
PANEL MOUNT HOSE BARB (ACETAL LOCKING SLEEVE)	1/16" ID	1.6mm ID	SMMPM0112	0.5 (12.7)	0.75 (19.1)
	1/8" ID	3.2mm ID	SMMPM0212	0.5 (12.7)	0.9 (22.9)

SMC COMPLETE IN-LINE COUPLINGS - Acetal



TERMINATION	TUBING/THREAD SIZE	METRIC EQ	STRAIGHT THRU	SHUTOFF	B
IN-LINE HOSE BARB	1/16" ID	1.6mm ID	SMC01	SMCD01	1.32/1.46 (33.5/37.1)
	1/16" ID	1.6mm ID	SMC01MBLK	SMCD01MBLK	1.32/1.46 (33.5/37.1)
	—	3.0mm ID	SMC02	SMCDM3	1.62 (41.1)
	—	3.0mm ID	SMC02MBLK		1.62 (41.1)
	1/8" ID	3.2mm ID		SMCD02	1.61 (40.9)
	1/8" ID	3.2mm ID			1.61 (40.9)

SMC COMPLETE IN-LINE COUPLINGS - Polypropylene



TERMINATION	TUBING/THREAD SIZE	METRIC EQ	STRAIGHT THRU	B
IN-LINE HOSE BARB	1/16" ID	1.6mm ID	SMC0112	1.32 (33.5)
	1/8" ID	3.2mm ID	SMC0212	1.61 (40.9)

SMC ACCESSORY CHART - Acetal



TERMINATION	O-RING MATERIAL	PART NO.	A	B
MALE PLUG	Buna-N	SMMP	0.48 (12.2)	0.50 (12.7)

All measurements are in inches (millimeters) unless otherwise noted. Tubing must meet stated inside and outside diameters. MBLK = molded black material. BLK = dyed black material.

NS1 SERIES CONNECTOR

NS1 Couplings compact design is packed full of features including non-spill shutoff valves that ensure drip-free disconnects, and eliminate the need to purge air from the system. The smallest plastic non-spill coupling on the market, NS1 is perfect for applications with tubing from 1/8-inch and smaller. Its rotating design allows tubing to move freely without kinks. Ideal for applications that need to be connected and disconnected often, the ergonomic, user-friendly interface enables a secure, reliable connect and disconnect.



SPECIFICATIONS

PRESSURE:

Vacuum to 15 psi, 1.0 bar

TEMPERATURE:

32°F to 120°F (0°C to 49°C)

MATERIALS:

Main Components:

Glass-filled polypropylene, PEEK®, polypropylene

Thumb latch: PEEK®

Springs: 316 stainless steel

O-rings: EPDM

COLOR: Gray

TUBING SIZES:

Microbore to 1/8" ID (Microbore to 3.2mm)

SPILLAGE:

0.02 cc per disconnect rated @ 15 psi

INCLUSION: 0.01 cc per connect

WARNING: Pressure, temperature, chemicals, and operating environment can affect the performance of couplings. It is the customer's responsibility to test the suitability of CPC products in their own application conditions.



cpcworldwide.com/NS1

FEATURES

Non-spill design



BENEFITS

Closed system for drip-free disconnect

Ultra low air inclusion



Minimizes contaminants, eliminates the need to purge air bubbles from the system

Intuitive interface



User friendly ergonomic design enables a secure, reliable connection

Rotating design



Allows tubing to move freely or relax without kinking or leaking

Chemically resistant materials



Reliable strength and performance in a range of applications

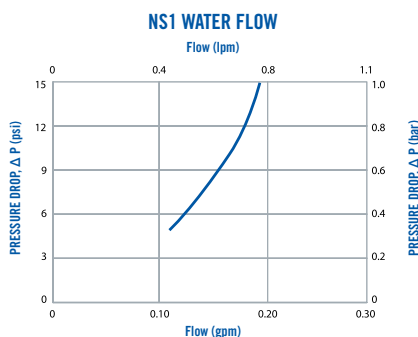

This graph intended to give you a general idea of the performance capabilities of each product line. The shaded area of each graph represents the operating range of the product family, i.e., upper and lower values are shown. Therefore, depending on the exact coupling configurations selected, you can reasonably expect values to fall within the shaded area.

NS1 SERIES DIMENSIONS

COUPLING BODIES - Polypropylene



TERMINATION	TUBING/THREAD SIZE	METRIC EQ.	SHUTOFF	A	B
IN-LINE HOSE BARB	1/8" ID	3.2 MM ID	NS1D170212	0.61 (15.5)	1.33 (33.8)
IN-LINE WITH A 1/4-28 FLAT BOTTOM PORT	1/8" OD OR SMALLER*	3.2 MM OD OR SMALLER*	NS1D19042812	0.61 (15.5)	1.21 (30.7)
IN-LINE WITH A 1/4-28 MALE THREAD			NS1D10042812	0.61 (15.5)	1.28 (32.5)

COUPLING INSERTS - Polypropylene



TERMINATION	TUBING/THREAD SIZE	METRIC EQ.	SHUTOFF	A	B
IN-LINE HOSE BARB	1/8" ID	3.2 MM ID	NS1D220212	0.44 (11.2)	1.04 (26.4)
IN-LINE WITH A 1/4-28 FLAT BOTTOM PORT	1/8" OD OR SMALLER*	3.2 MM OD OR SMALLER*	NS1D26042812	0.44 (11.2)	0.92 (23.4)
IN-LINE WITH A 1/4-28 MALE THREAD			NS1D24042812	0.49 (12.4)	0.99 (25.1)
PANEL MOUNT HOSE BARB	1/8" ID	3.2 MM ID	NS1D420212	0.7 (17.8)	1.56 (39.6)
PANEL MOUNT WITH A 1/4-28 FLAT BOTTOM PORT	1/8" OD OR SMALLER*	3.2 MM OD OR SMALLER*	NS1D48042812	0.7 (17.8)	1.45 (36.8)

*Tubing size dependent on nut and ferrule used with 1/4-28 port.

ACCESSORIES



DESCRIPTION	MATERIAL	PART NO.
BULKHEAD O-RING: FOR SEALING PANEL MOUNT INSERTS LISTED ABOVE	EPDM	731303

FERRULES



FOR 1/4-28 NUTS AND FERRULES, SEE PAGE 37 OR VISIT CPCWORLDWIDE.COM

PRODUCT DIMENSIONS

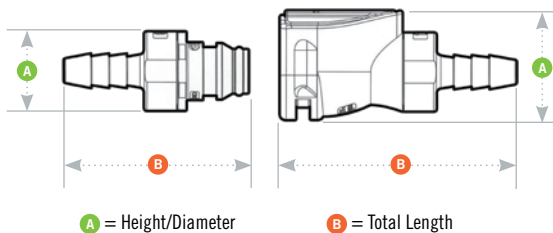

PANEL DIMENSIONS

	PANEL OPENING	PANEL THICKNESS MAX. - MIN.	PANEL NUT HEX	PANEL NUT THREAD
COUPLING INSERTS	see drawing	0.29 - 0.05	5/8	1/2-24UNS

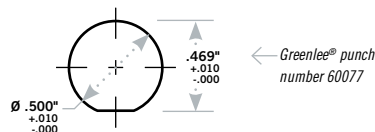

PMC SERIES CONNECTOR

The 1/8" flow PMC coupling covers a wide variety of general-purpose applications. Featuring the CPC thumb latch, the PMC is easier to use than ball-and-sleeve designs. One-hand connection/disconnection and integral terminations make the PMC the choice for ease of use and manufacture. This coupling is NuSeal® compatible.



SPECIFICATIONS

PRESSURE:

Vacuum to 120 psi, 8.3 bar

TEMPERATURE:

-40°F to 180°F (-40°C to 82°C)

MATERIALS:

Main components and valves: Acetal

Thumb latch: Stainless steel

Valve spring: 316 stainless steel

External springs and pin: Stainless steel

O-rings: Buna-N

COLOR:

Natural white, others available

TUBING SIZES:

1/16" to 1/4" ID, 1.6mm to 6.4mm ID

WARNING: Pressure, temperature, chemicals, and operating environment can affect the performance of couplings. It is the customer's responsibility to test the suitability of CPC products in their own application conditions.



cpcworldwide.com/PMC

FEATURES

Hose barb shroud

Integral terminations

Compatible

Clicks when connected

BENEFITS

Extra protection for the 1/16" hose barb

Fewer leak points, shorter assemblies, faster installations

Mates with PMC12 and MC Series couplings (see pages 34 and 38)

Assurance of a reliable connection

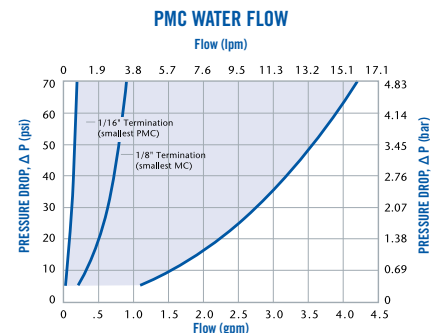
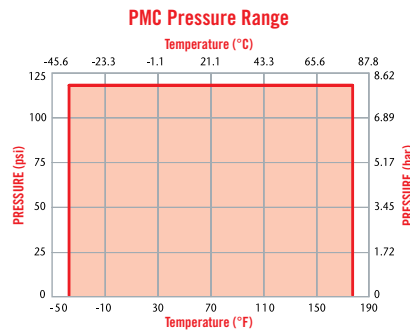
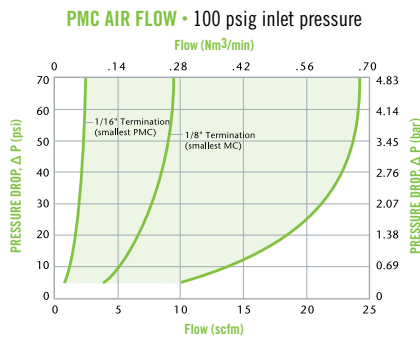

These graphs are intended to give you a general idea of the performance capabilities of each product line. The shaded area of each graph represents the operating range of the product family, i.e., upper and lower values are shown. Therefore, depending on the exact coupling configurations selected, you can reasonably expect values to fall within the shaded area.

NU-SEAL® QUICK DISCONNECT COUPLING

NU-SEAL® SPECIFICATIONS

PRESSURE:

Vacuum to 20 psi, 1.4 bar

MATERIALS:

Main components:

Low density polyethylene

COLOR:

Translucent

TUBING SIZE:

1/8" ID, 3.2mm ID

Nu-Seal® quick disconnect coupling inserts feature a patented integral seal and are USP Class VI compliant. These economic inserts are ideal for applications that require limited connect/disconnect cycles.

FEATURES

- Integral seal → Economical, allows for disposability and provides leak-free connections
- Low density polyethylene → Sterilizable by EtO, E-beam & gamma
- Chemically resistant → Works in many critical USP Class VI material applications
- Compatible → Mates with MC, PMC, PMC12 couplings

BENEFITS



TERMINATION	TUBING SIZE	STRAIGHT THRU	SHUTOFF	A	B
IN-LINE HOSE BARB	1/8" ID	3.2mm ID	DSM2202	0.50	0.98

LIQUID FLOW RATE INFORMATION FOR COUPLINGS

The chart below shows the flow rate for CPC couplings. Each coupling was tested with water at 70°F (21°C). To determine flow rates for specific coupling configurations use the formula to the right.

$$Q = C_v \sqrt{\frac{\Delta P}{S}}$$

- Q = Flow rate in gallons per minute
- C_v = Average coefficient across various flow rates (see chart)
- ΔP = Pressure drop across coupling (psi)
- S = Specific gravity of liquid







C_v VALUES

INSERTS

BODIES	INSERTS																
	PMC 2004	PMCD 2004	PMC 2006	PMCD 2006	PMC 2202	PMCD 2202	PMC 2204	PMCD 2204	PMC 2402	PMCD 2402	PMC 2404	PMCD 2304	PMC 2104	PMC 2203	PMCD 2203	PMC 2201	PMCD 2201
PMC1002	0.40	0.18	0.50	0.19	0.25	0.16	0.50	0.19	0.50	0.20	0.51	0.19	0.38	0.30	0.17	0.03	0.03
PMCD1002	0.27	0.18	0.31	0.18	0.24	0.16	0.28	0.20	0.26	0.20	0.29	0.18	0.27	0.25	0.17	0.03	0.03
PMC1004	0.40	0.21	0.50	0.24	0.26	0.18	0.50	0.24	0.50	0.20	0.51	0.24	0.38	0.30	0.19	0.03	0.03
PMCD1004	0.29	0.19	0.32	0.23	0.25	0.17	0.30	0.23	0.27	0.21	0.28	0.23	0.29	0.25	0.18	0.03	0.03
PMC1204	0.40	0.18	0.50	0.18	0.25	0.16	0.40	0.18	0.40	0.16	0.36	0.18	0.38	0.30	0.17	0.03	0.03
PMCD1204	0.21	0.17	0.22	0.17	0.20	0.16	0.22	0.17	0.21	0.17	0.20	0.17	0.21	0.21	0.16	0.03	0.03
PMC1602	0.23	0.15	0.28	0.18	0.19	0.14	0.27	0.15	0.27	0.15	0.28	0.18	0.23	0.20	0.14	0.03	0.03
PMCD1602	0.19	0.15	0.19	0.15	0.17	0.14	0.19	0.15	0.18	0.15	0.18	0.15	0.19	0.18	0.14	0.03	0.03
PMC1604	0.33	0.23	0.44	0.24	0.24	0.18	0.44	0.23	0.44	0.20	0.38	0.24	0.33	0.26	0.19	0.03	0.03
PMCD1604	0.23	0.17	0.26	0.21	0.22	0.16	0.26	0.21	0.26	0.19	0.25	0.21	0.23	0.22	0.16	0.03	0.03
PMC1703	0.25	0.20	0.30	0.20	0.20	0.17	0.30	0.20	0.30	0.19	0.28	0.20	0.25	0.21	0.17	0.03	0.03
PMCD1703	0.20	0.17	0.20	0.17	0.19	0.15	0.21	0.17	0.19	0.17	0.20	0.17	0.20	0.19	0.16	0.03	0.03
PMC1701	0.03	0.03	0.03	0.03	0.03	0.03	0.03	0.03	0.03	0.03	0.03	0.03	0.03	0.03	0.03	0.03	0.02
PMCD1701	0.03	0.03	0.03	0.03	0.03	0.03	0.03	0.03	0.03	0.03	0.03	0.03	0.03	0.03	0.03	0.03	0.02

PMC SERIES DIMENSIONS

COUPLING BODIES - Acetal

TERMINATION	TUBING/THREAD SIZE	METRIC EQ	STRAIGHT THRU	SHUTOFF	A	B
 IN-LINE PIPE THREAD	1/8" NPT		PMC1002	PMCD1002	0.79 (20.1)	1 (25.4)
	1/8" BSPT		PMC1002BSPT	PMCD1002BSPT	0.79 (20.1)	1 (25.4)
	1/4" NPT		PMC1004	PMCD1004	0.79 (20.1)	1.1 (27.9)
	1/4" BSPT		PMC1004BSPT	PMCD1004BSPT	0.79 (20.1)	1.1 (27.9)
 PANEL MOUNT FERRULELESS POLYTUBE FITTING, PTF†	—	4.0mm OD, 2.0mm ID	PMC12M42	PMCD12M42	0.77 (19.6)	1.65 (41.9)
	5/32" OD, 0.10" ID	4.0mm OD, 2.5mm ID	PMC12025	PMCD12025	0.77 (19.6)	1.7 (43.2)
	1/4" OD, 0.17" ID	6.4mm OD, 4.3mm ID	PMC1204	PMCD1204	0.77 (19.6)	1.72 (43.7)
 PANEL MOUNT HOSE BARB	1/16" ID	1.6mm ID	PMC1601	PMCD1601	0.77 (19.6)	1.4 (35.6)
	1/8" ID	3.2mm ID	PMC1602	PMCD1602	0.77 (19.6)	1.65 (41.9)
	3/16" ID	4.8mm ID	PMC1603	PMCD1603	0.77 (19.6)	1.85 (47.0)
	1/4" ID	6.4mm ID	PMC1604	PMCD1604	0.77 (19.6)	1.85 (47.0)
 PANEL MOUNT FEMALE THREAD	10-32 UNF		PMC181032	PMCD181032	0.77 (19.6)	1.25 (31.8)
 IN-LINE FERRULELESS POLYTUBE FITTING, PTF†	—	4.0mm OD, 2.0mm ID	PMC13M42	PMCD13M42	0.81 (20.6)	1.65 (41.9)
	5/32" OD, 0.10" ID	4.0mm OD, 2.5mm ID	PMC13025	PMCD13025	0.81 (20.6)	1.65 (41.9)
	1/4" OD, 0.17" ID	6.4mm OD, 4.3mm ID	PMC1304	PMCD1304	0.81 (20.6)	1.75 (44.5)
 IN-LINE HOSE BARB	1/16" ID	1.6mm ID	PMC1701	PMCD1701	0.81 (20.6)	1.41 (35.81)
	1/8" ID	3.2mm ID	PMC1702	PMCD1702	0.81 (20.6)	1.45/1.65 (36.8/41.9)
	3/16" ID	4.8mm ID	PMC1703	PMCD1703	0.81 (20.6)	1.65/1.85 (41.9/47.0)
	1/4" ID	6.4mm ID	PMC1704	PMCD1704	0.81 (20.6)	1.65/1.85 (41.91/47.0)
 IN-LINE FEMALE THREAD	10-32 UNF		PMC191032	PMCD191032	0.81 (20.6)	1.25 (31.8)

All measurements are in inches (millimeters) unless otherwise noted. Tubing must meet stated inside and outside diameters. †NOTE: CPC's Ferruleless PTF (polytube fitting) terminations do not require ferrules to achieve a secure connection and are therefore easier to use and reuse. PTF fittings are designed for semi-rigid tubing, i.e., polyethylene, nylon, polyurethane, etc.

PRODUCT DIMENSIONS

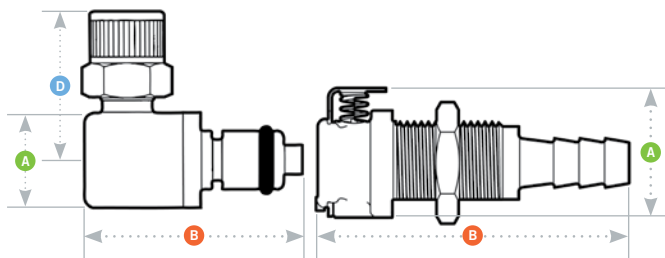







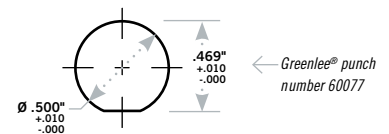

- A** = Height/Diameter
- B** = Total Length
- D** = Elbow Radial Length

PANEL DIMENSIONS

	PANEL OPENING	PANEL THICKNESS MAX. – MIN.	PANEL NUT HEX	PANEL NUT THREAD
COUPLING BODIES	see drawing	0.50 – 0.05	5/8	1/2-24UNS
COUPLING INSERTS	1/2	0.30 – 0.05	5/8	1/2-24UNS



COUPLING INSERTS - Acetal

TERMINATION	TUBING/THREAD SIZE	METRIC EQ	STRAIGHT THRU	SHUTOFF	A	B	D
 IN-LINE PIPE THREAD	1/8" NPT		PMC2402	PMCD2402	0.58 (14.7)	1.03/1.45 (26.2/36.8)	
	1/8" BSPT		PMC2402BSPT	PMCD2402BSPT	0.58 (14.7)	1.03/1.44 (26.2/36.6)	
	1/4" NPT		PMC2404	PMCD2404	0.65 (16.5)	1.13/1.42 (28.7/36.1)	
	1/4" BSPT		PMC2404BSPT	PMCD2404BSPT	0.65 (16.5)	1.13/1.42 (28.7/36.1)	
 PANEL MOUNT FERRULELESS POLYTUBE FITTING, PTF† (NON-VALVED SHOWN)	1/4" OD, 0.17" ID	6.4mm OD, 4.3mm ID	PMC4004	PMCD4004	0.72 (18.3)	1.70/1.82 (43.2/46.2)	
 PANEL MOUNT HOSE BARB	1/16" ID	1.6mm ID	PMC4201	PMCD4201	0.72 (18.3)	1.38/1.50 (35.1/38.1)	
	1/8" ID	3.2mm ID	PMC4202	PMCD4202	0.72 (18.3)	1.63/1.75 (41.4/44.5)	
	3/16" ID	4.8mm ID	PMC4203	PMCD4203	0.72 (18.3)	1.83/1.95 (46.5/49.5)	
	1/4" ID	6.4mm ID	PMC4204	PMCD4204	0.72 (18.3)	1.83/1.95 (46.5/49.6)	
 IN-LINE FERRULELESS POLYTUBE FITTING, PTF†	—	4.0mm OD, 2.0mm ID	PMC20M42	PMCD20M42	0.58 (14.7)	1.08/1.60 (27.4/40.6)	
	5/32" OD, 0.10" ID	4.0mm OD, 2.5mm ID	PMC20025	PMCD20025	0.58 (14.7)	1.13/1.65 (28.7/41.9)	
	1/4" OD, 0.17" ID	6.4mm OD, 4.3mm ID	PMC2004	PMCD2004	0.58 (14.7)	1.15/1.57 (29.2/39.9)	
	3/8" OD, 0.25" ID	9.5mm OD, 6.4mm ID	PMC2006	PMCD2006	0.65 (16.5)	1.40/1.52 (35.6/38.6)	
 IN-LINE HOSE BARB (NON-VALVED SHOWN)	1/16" ID	1.6mm ID	PMC2201	PMCD2201	0.5 (12.7)	0.80/1.47 (20.3/37.3)	
	1/8" ID	3.2mm ID	PMC2202	PMCD2202	0.5 (12.7)	1.00/1.67 (25.4/42.4)	
	3/16" ID	4.8mm ID	PMC2203	PMCD2203	0.5 (12.7)	1.20/1.88 (30.5/47.8)	
	1/4" ID	6.4mm ID	PMC2204	PMCD2204	0.5 (12.7)	1.22/1.70 (31.0/43.2)	
 IN-LINE FEMALE THREAD	10-32 UNF		PMC281032	PMCD281032	0.58 (14.7)	0.63/1.31 (16.0/33.3)	
 ELBOW FERRULELESS POLYTUBE FITTING, PTF†	5/32" OD, 0.10" ID	4.0mm OD, 2.5mm ID	PMC21025		0.5 (12.7)	1.17 (29.7)	0.75 (19.1)
	1/4" OD, 0.17" ID	6.4mm OD, 4.3mm ID	PMC2104	PMCD2104	0.5 (12.7)	1.17/1.21 (29.7/30.7)	0.77 (19.6)
 ELBOW HOSE BARB (NON-VALVED SHOWN)	1/8" ID	3.2mm ID	PMC2302	PMCD2302	0.5 (12.7)	0.85/1.21 (21.6/30.7)	0.75/0.69 (19.1/17.5)
	1/4" ID	6.4mm ID	PMC2304	PMCD2304	0.5 (12.7)	1.00/1.21 (25.4/30.7)	0.95/0.90 (24.1/22.9)

All measurements are in inches (millimeters) unless otherwise noted. Tubing must meet stated inside and outside diameters. Couplings are pictured with valves unless otherwise noted. †NOTE: CPC's Ferruleless PTF (polytube fitting) terminations do not require ferrules to achieve a secure connection and are therefore easier to use and reuse. PTF fittings are designed for semi-rigid tubing, i.e., polyethylene, nylon, polyurethane, etc.

NSF

NSF OPTION AVAILABLE

This product has an NSF compatible product for food applications. Our food-grade couplings are superior to general fittings for fluid control because they incorporate built-in shutoff valves, enabling tubing to be disconnected without having to turn off the water supply. Scan the QR code to be taken to the NSF specific product web page.



PMC12 SERIES CONNECTOR

The 1/8" flow polypropylene **PMC12** offers many of the same configuration options as the PMC. The polypropylene material adds greater chemical resistance and is gamma sterilizable. The PMC12 also mates to small diameter rigid tubing. Available with a 1/4-28 flat bottom port and 1/4-28 UNF threads, these couplings eliminate the need to thread and re-thread common compression nuts each time a tubing connection is made.

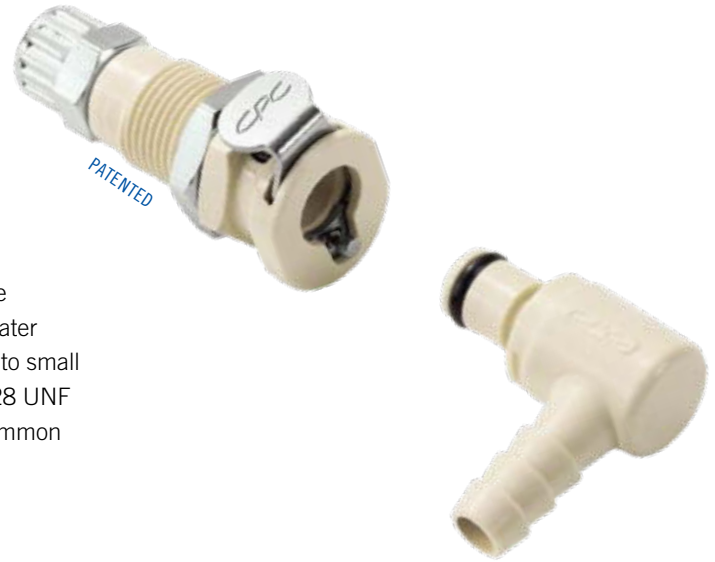

SPECIFICATIONS

PRESSURE:

Vacuum to 120 psi, 8.3 bar

TEMPERATURE:

32°F to 160°F (0°C to 71°C)

MATERIALS:

Main components and valves: Polypropylene

Thumb latch: Stainless steel

Valve spring: 316 stainless steel

External spring and pin: Stainless steel

O-rings: EPDM

STERILIZATION:

Gamma: Up to 50 kGy irradiation

COLOR:

Almond

TUBING SIZES:

Microbore to 1/4" ID, Microbore to 6.4mm ID

WARNING: Pressure, temperature, chemicals, and operating environment can affect the performance of couplings. It is the customer's responsibility to test the suitability of CPC products in their own application conditions.



cpcworldwide.com/PMC12

FEATURES

- Polypropylene material → Chemically resistant and gamma sterilizable
- EPDM o-ring → Greater chemical resistance
- CPC thumb latch → One-hand connection and disconnection
- Integral terminations → Fewer leak points, shorter assemblies, faster installations

BENEFITS

PMC12 AIR FLOW • 100 psig inlet pressure

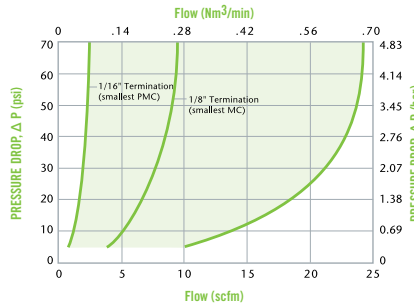

PMC12 Pressure Range

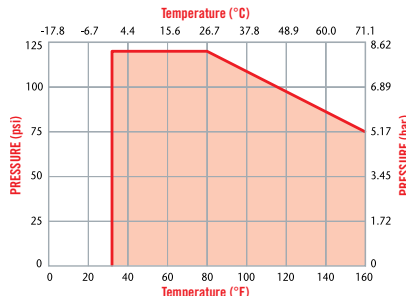

PMC12 WATER FLOW

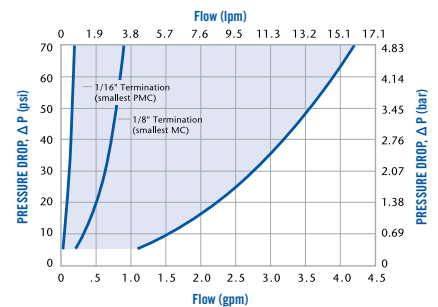

These graphs are intended to give you a general idea of the performance capabilities of each product line. The shaded area of each graph represents the operating range of the product family, i.e., upper and lower values are shown. Therefore, depending on the exact coupling configurations selected, you can reasonably expect values to fall within the shaded area.



CUSTOM PROJECT CAPABILITIES

CPC can develop a solution unique to your needs. Watch our video to learn more...



LIQUID FLOW RATE INFORMATION FOR COUPLINGS

The chart below shows the flow rate for CPC couplings. Each coupling was tested with water at 70°F (21°C). To determine flow rates for specific coupling configurations use the formula to the right.

$$Q = C_v \sqrt{\frac{\Delta P}{S}}$$

- Q = Flow rate in gallons per minute
- C_v = Average coefficient across various flow rates (see chart)
- ΔP = Pressure drop across coupling (psi)
- S = Specific gravity of liquid





C_v VALUES

INSERTS



	PMC	PMCD	PMC	PMCD	PMC	PMCD	PMC	PMCD	PMC	PMCD	PMC	PMCD	PMC	PMCD	PMC	PMCD	PMC	PMCD
	200412	200412	200612	200612	220212	220212	220412	220412	240212	240212	240412	230412	210412	230412	220312	220312	220112	220112
PMC100212	0.40	0.18	0.50	0.19	0.25	0.16	0.50	0.19	0.50	0.20	0.51	0.19	0.38	0.24	0.30	0.17	0.03	0.03
PMCD100212	0.27	0.18	0.31	0.18	0.24	0.16	0.28	0.20	0.26	0.20	0.29	0.18	0.27	0.24	0.25	0.17	0.03	0.03
PMC100412	0.40	0.21	0.50	0.24	0.26	0.18	0.50	0.24	0.50	0.20	0.51	0.24	0.38	0.26	0.30	0.19	0.03	0.03
PMCD100412	0.29	0.19	0.32	0.23	0.25	0.17	0.30	0.23	0.27	0.21	0.28	0.23	0.29	0.24	0.25	0.18	0.03	0.03
PMC120412	0.40	0.18	0.50	0.18	0.25	0.16	0.40	0.18	0.40	0.16	0.36	0.18	0.38	0.21	0.30	0.17	0.03	0.03
PMCD120412	0.21	0.17	0.22	0.17	0.20	0.16	0.22	0.17	0.21	0.17	0.20	0.17	0.21	0.18	0.21	0.16	0.03	0.03
PMC160212	0.23	0.15	0.28	0.18	0.19	0.14	0.27	0.15	0.27	0.15	0.28	0.18	0.23	0.16	0.20	0.14	0.03	0.03
PMCD160212	0.19	0.15	0.19	0.15	0.17	0.14	0.19	0.15	0.18	0.15	0.18	0.15	0.19	0.15	0.18	0.14	0.03	0.03
PMC160412	0.33	0.23	0.44	0.24	0.24	0.18	0.44	0.23	0.44	0.20	0.38	0.24	0.33	0.26	0.26	0.19	0.03	0.03
PMCD160412	0.23	0.17	0.26	0.21	0.22	0.16	0.26	0.21	0.26	0.19	0.25	0.21	0.23	0.24	0.22	0.16	0.03	0.03
PMC170312	0.25	0.20	0.30	0.20	0.20	0.17	0.30	0.20	0.30	0.19	0.28	0.20	0.25	0.18	0.21	0.17	0.03	0.03
PMCD170312	0.20	0.17	0.20	0.17	0.19	0.15	0.21	0.17	0.19	0.17	0.20	0.17	0.20	0.16	0.19	0.16	0.03	0.03
PMC170112	0.03	0.03	0.03	0.03	0.03	0.03	0.03	0.03	0.03	0.03	0.03	0.03	0.03	0.03	0.03	0.03	0.03	0.02
PMCD170112	0.03	0.03	0.03	0.03	0.03	0.03	0.03	0.03	0.03	0.03	0.03	0.03	0.03	0.03	0.03	0.03	0.02	0.02

PMC12 SERIES DIMENSIONS

COUPLING BODIES - Polypropylene

TERMINATION	TUBING/THREAD SIZE	METRIC EQ	STRAIGHT THRU	SHUTOFF	A	B
 IN-LINE PIPE THREAD	1/8" NPT		PMC100212	PMCD100212	0.88 (22.4)	1 (25.4)
	1/8" BSPT		PMC100212BSPT	PMCD100212BSPT	0.88 (22.4)	1 (25.4)
	1/4" NPT		PMC100412	PMCD100412	0.88 (22.4)	1.1 (27.9)
	1/4" BSPT		PMC100412BSPT	PMCD100412BSPT	0.88 (22.4)	1.1 (27.9)
 PANEL MOUNT FERRULELESS POLYTUBE FITTING, PTF†	1/4" OD, 0.17" ID	6.4mm OD, 4.3mm ID	PMC120412	PMCD120412	0.79 (20.1)	1.72 (43.7)
 PANEL MOUNT HOSE BARB	1/16" ID	1.6mm ID	PMC160112	PMCD160112	0.88 (22.4)	1.4 (35.6)
	1/8" ID	3.2mm ID	PMC160212	PMCD160212	0.88 (22.4)	1.65 (41.9)
	1/4" ID	6.4mm ID	PMC160412	PMCD160412	0.88 (22.4)	1.85 (47.0)
 IN-LINE FERRULELESS POLYTUBE FITTING, PTF†	1/4" OD, 0.17" ID	6.4mm OD, 4.3mm ID		PMCD130412	0.89 (22.6)	1.74 (44.2)
 IN-LINE HOSE BARB	1/16" ID	1.6mm ID	PMC170112	PMCD170112	0.89 (22.6)	1.42 (36.1)
	1/8" ID	3.2mm ID	PMC170212	PMCD170212	0.89 (22.6)	1.67 (42.4)
	1/4" ID	6.4mm ID	PMC170412	PMCD170412	0.89 (22.6)	1.87 (47.5)

PMC12 1/4-28 COUPLING BODIES - Polypropylene

TERMINATION	SHUTOFF	A	B
 TERMINATION PANEL MOUNT WITH A 1/4-28 FLAT BOTTOM PORT	PMCD18042812	0.88 (22.4)	1.57 (39.9)
 IN-LINE WITH A 1/4-28 FLAT BOTTOM PORT	PMCD19042812	0.89 (22.6)	1.57 (39.9)

All measurements are in inches (millimeters) unless otherwise noted. Tubing must meet stated inside and outside diameters. Couplings are pictured with valves unless otherwise noted.
 †NOTE: CPC's Ferruleless PTF (polytube fitting) terminations do not require ferrules to achieve a secure connection and are therefore easier to use and reuse. PTF fittings are designed for semi-rigid tubing, i.e., polyethylene, nylon, polyurethane, etc.

PRODUCT DIMENSIONS

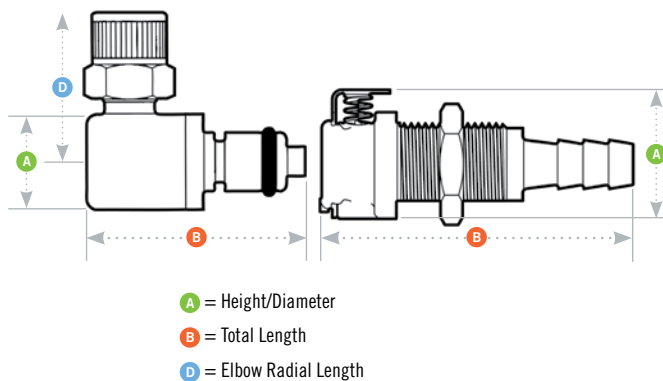





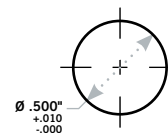

PANEL DIMENSIONS

	PANEL OPENING	PANEL THICKNESS MAX. - MIN.	PANEL NUT HEX	PANEL NUT THREAD
COUPLING BODIES	see drawing	0.50 - 0.05	5/8	1/2-24UNS
COUPLING INSERTS	see drawing	0.30 - 0.06	5/8	1/2-24UNS



COUPLING INSERTS - Polypropylene

TERMINATION	TUBING/THREAD SIZE	METRIC EQ	STRAIGHT THRU	SHUTOFF	A	B	D
 IN-LINE PIPE THREAD	1/8" NPT		PMC240212	PMCD240212	0.58 (14.7)	1.03/1.45 (26.16/36.83)	
 PANEL MOUNT IN-LINE HOSE BARB	1/16" ID	3.2mm ID	PMC420212	PMCD420212	0.72 (18.3)	1.74/1.82 (44.2/46.2)	
	1/8" ID	1.6mm ID		PMCD420112	0.72 (18.3)	1.57 (39.9)	
	1/4" ID	6.4mm ID		PMCD420412	0.72 (18.3)	2.04 (51.8)	
	1/4" ID	6.4mm ID		PMCD400412	0.72 (18.3)	1.81 (46.0)	
 IN-LINE FERRULELESS POLYTUBE FITTING, PTF†	1/4" OD, 0.17" ID	6.4mm OD, 4.3mm ID	PMC200412	PMCD200412	0.58 (14.7)	1.15/1.58 (29.2/40.1)	
 IN-LINE HOSE BARB (NON-VALVED SHOWN)	1/16" ID	1.6mm ID	PMC220112	PMCD220112	0.5 (12.7)	0.80/1.47 (20.3/37.3)	
	1/8" ID	3.2mm ID	PMC220212	PMCD220212	0.5 (12.7)	1.05/1.67 (26.7/42.4)	
	1/4" ID	6.4mm ID	PMC220412	PMCD220412	0.5 (12.7)	1.20/1.71 (30.5/43.4)	
 IN-LINE STRAIGHT THREAD PORT SAE	5/16 SAE-5		PMC24082012	PMCD24082012	0.72 (18.3)	1.05/1.15 (26.7/29.2)	
 ELBOW FERRULELESS POLYTUBE FITTING, PTF†	5/32" OD, 0.10" ID	4.0mm OD, 2.5mm ID	PMC2102512	PMCD2102512	0.5 (12.7)	1.09/1.21 (27.7/30.7)	0.77 (19.6)
	1/4" OD, 0.17" ID	6.4mm OD, 4.3mm ID	PMC210412	PMCD210412	0.5 (12.7)	1.17/1.21 (29.7/30.7)	0.77 (19.6)
 ELBOW HOSE BARB	1/8" ID	3.2mm ID	PMC230212	PMCD230212	0.5 (12.7)	1.09/1.21 (27.7/30.7)	0.69 (17.5)
	1/4" ID	6.4mm ID	PMC230412	PMCD230412	0.5 (12.7)	1.09/1.21 (27.7/30.7)	0.9 (22.8)

PMC12 1/4-28 COUPLING INSERTS - Polypropylene

TERMINATION	STRAIGHT THRU	SHUTOFF	A	B	D
 IN-LINE WITH 1/4-28 UNF THREADS	PMC24042812	PMCD24042812	0.50 (12.70)	1.5 37.6	
 PANEL MOUNT WITH A 1/4-28 FLAT BOTTOM PORT		PMCD48042812	0.72 (18.29)	1.6 39.4	

NUTS



TUBING SIZE	DESCRIPTION	PART NO.
1/16" and 1.8mm	1/4-28 Polypropylene Nut (natural)	2418900
1/8" and 3mm	1/4-28 Polypropylene Nut (natural)	2419000
1/16" and 1.8mm	1/4-28 Acetal Nut (black)	2419199
1/8" and 3mm	1/4-28 Acetal Nut (black)	2419299

FERRULES



TUBING SIZE	DESCRIPTION	PART NO.
1/16"	Ferrule, ETFE (blue)	2419300
1/8"	Ferrule, ETFE (yellow)	2419400
1.8mm	Ferrule, ETFE (green)	2419500
3.0mm	Ferrule, ETFE (orange)	2419600

All measurements are in inches (millimeters) unless otherwise noted. Tubing must meet stated inside and outside diameters. Couplings are pictured with valves unless otherwise noted.

†NOTE: CPC's Ferruleless PTF (polytube fitting) terminations do not require ferrules to achieve a secure connection and are therefore easier to use and reuse. PTF fittings are designed for semi-rigid tubing, i.e., polyethylene, nylon, polyurethane, etc.

MC SERIES CONNECTOR

CPC's MC Series chrome-plated brass couplings are built tough and made to last in the most demanding applications. Ideal for use with higher temperatures or pressures, MC Series couplings feature one-hand operation for swift and easy connects and disconnects. These couplings offer the flexibility of multiple configurations and terminations and mate with both PMC acetal and PMC12 polypropylene couplings.



SPECIFICATIONS

PRESSURE:

Vacuum to 250 psi, 17.3 bar

TEMPERATURE:

-40°F to 180°F (-40°C to 82°C)
(High temperature versions available with ratings to 400°F)

MATERIALS:

Main components:

Chrome-plated brass

Thumb latch: Stainless steel

Valves: Acetal

Valve spring: 316 stainless steel

External springs and pin: Stainless steel

O-rings: Buna-N

FINISH: Chrome

TUBING SIZES:

1/8" to 1/4" ID, 3.2mm to 6.4mm ID

WARNING: Pressure, temperature, chemicals, and operating environment can affect the performance of couplings. It is the customer's responsibility to test the suitability of CPC products in their own application conditions.



cpcworldwide.com/MC

FEATURES

Brass material



High temperature capability



CPC thumb latch



Compatible



BENEFITS

Durable and able to withstand higher pressure and temperature

Versions rated to 400°F (204°C)

One-hand connection and disconnection

MC mates with PMC and PMC12 Series couplings

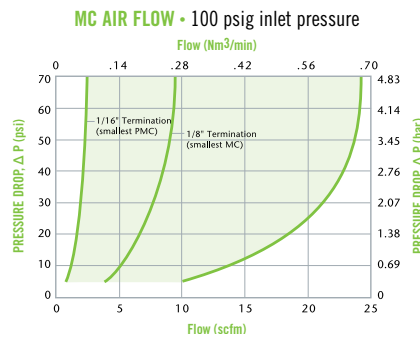
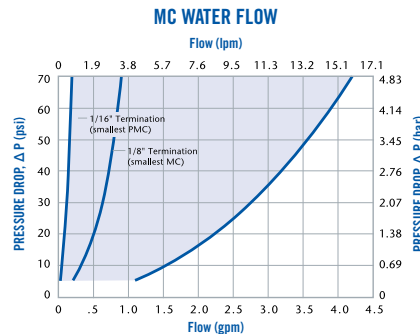

These graphs are intended to give you a general idea of the performance capabilities of each product line. The shaded area of each graph represents the operating range of the product family, i.e., upper and lower values are shown. Therefore, depending on the exact coupling configurations selected, you can reasonably expect values to fall within the shaded area.

DID YOU KNOW

CPC's MC Series couplings are also available in keyed, color-coded versions? Specifically designed for applications requiring foolproof connections and non-interchangeable lines, these couplings are a durable and attractive solution for high-volume applications. Contact CPC for more information.



NOTE

High temperature versions available with ratings to 400 F. Call customer service for more information.

KEYED BODIES - Chrome-plated brass



TERMINATION	TUBING/THREAD SIZE	METRIC EQ	COLOR KEY	STRAIGHT THRU	SHUTOFF
NPT	1/8"	3.2MM	ORANGE	MC1002K1	MCD1002K1
	1/8"	3.2MM	YELLOW	MC1002K2	MCD1002K2
	1/8"	3.2MM	BLUE	MC1002K3	MCD1002K3
	1/4"	6.4MM	ORANGE	MC1004K1	MCD1004K1
	1/4"	6.4MM	YELLOW	MC1004K2	MCD1004K2
	1/4"	6.4MM	BLUE	MC1004K3	MCD1004K3
PANEL MOUNT PTF	1/4"	6.4MM	ORANGE	MC1204K1	MCD1204K1
	1/4"	6.4MM	YELLOW	MC1204K2	MCD1204K2
	1/4"	6.4MM	BLUE	MC1204K3	MCD1204K3
PANEL MOUNT HB	1/8"	3.2MM	ORANGE	MC1602K1	MCD1602K1
	1/8"	3.2MM	YELLOW	MC1602K2	MCD1602K2
	1/8"	3.2MM	BLUE	MC1604K3	MCD1602K3
	1/4"	6.4MM	ORANGE	MC1604K1	MCD1604K1
	1/4"	6.4MM	YELLOW	MC1604K2	MCD1604K2
	1/4"	6.4MM	BLUE	MC1604K3	MCD1604K3

KEYED INSERTS - Chrome-plated brass



TERMINATION	TUBING/THREAD SIZE	METRIC EQ	COLOR KEY	STRAIGHT THRU	SHUTOFF
IN-LINE PTF	1/4"	6.4MM	ORANGE	MC2004K1	
	1/4"	6.4MM	YELLOW	MC2004K2	
	1/4"	6.4MM	BLUE	MC2004K3	
IN-LINE HB	1/8"	3.2MM	ORANGE	MC2202K1	
	1/8"	3.2MM	YELLOW	MC2202K2	
	1/8"	3.2MM	BLUE	MC2202K3	
IN-LINE HB	1/4"	6.4MM	ORANGE	MC2204K1	
	1/4"	6.4MM	YELLOW	MC2204K2	
	1/4"	6.4MM	BLUE	MC2204K3	
NPT	1/8"	3.2MM	ORANGE	MC2402K1	
	1/8"	3.2MM	YELLOW	MC2402K2	
	1/8"	3.2MM	BLUE	MC2402K3	

LIQUID FLOW RATE INFORMATION FOR COUPLINGS

The chart below shows the flow rate for CPC couplings. Each coupling was tested with water at 70°F (21°C). To determine flow rates for specific coupling configurations use the formula to the right.

$$Q = C_v \sqrt{\frac{\Delta P}{S}}$$

Q = Flow rate in gallons per minute
 C_v = Average coefficient across various flow rates (see chart)
 ΔP = Pressure drop across coupling (psi)
 S = Specific gravity of liquid

C_v VALUES

INSERTS

	BODIES															
	MC 2004	MCD 2004	MC 2006	MCD 2006	MC 2202	MCD 2202	MC 2204	MCD 2204	MC 2402	MCD 2402	MC 2404	MCD 2304	MC 2602	MC 2104	MC 2203	MCD 2203
MC1002	0.40	0.18	0.50	0.19	0.25	0.16	0.50	0.19	0.50	0.20	0.51	0.19	0.50	0.38	0.30	0.17
MCD1002	0.27	0.18	0.31	0.18	0.24	0.16	0.28	0.20	0.26	0.20	0.29	0.18	0.26	0.27	0.25	0.17
MC1004	0.40	0.21	0.50	0.24	0.26	0.18	0.50	0.24	0.50	0.20	0.51	0.24	0.50	0.38	0.30	0.19
MCD1004	0.29	0.19	0.32	0.23	0.25	0.17	0.30	0.23	0.27	0.21	0.28	0.23	0.27	0.29	0.25	0.183
MC1204	0.40	0.18	0.50	0.18	0.25	0.16	0.40	0.18	0.40	0.16	0.36	0.18	0.40	0.38	0.30	0.173
MCD1204	0.21	0.17	0.22	0.17	0.20	0.16	0.22	0.17	0.21	0.17	0.20	0.17	0.21	0.21	0.21	0.16
MC1602	0.23	0.15	0.28	0.18	0.19	0.14	0.27	0.15	0.27	0.15	0.28	0.18	0.27	0.23	0.20	0.14
MCD1602	0.19	0.15	0.19	0.15	0.17	0.14	0.19	0.15	0.18	0.15	0.18	0.15	0.18	0.19	0.18	0.14
MC1604	0.33	0.23	0.44	0.24	0.24	0.18	0.44	0.23	0.44	0.20	0.38	0.24	0.38	0.33	0.26	0.19
MCD1604	0.23	0.17	0.26	0.21	0.22	0.16	0.26	0.21	0.26	0.19	0.25	0.21	0.21	0.23	0.22	0.16
MC1703	0.25	0.20	0.30	0.20	0.20	0.17	0.30	0.20	0.30	0.19	0.28	0.20	0.28	0.25	0.21	0.17
MCD1703	0.20	0.17	0.20	0.17	0.19	0.15	0.21	0.17	0.19	0.17	0.20	0.17	0.19	0.20	0.19	0.16

MC SERIES DIMENSIONS

COUPLING BODIES - Chrome-plated brass

TERMINATION	TUBING/THREAD SIZE	METRIC EQ	STRAIGHT THRU	SHUTOFF	A	B
IN-LINE PIPE THREAD	1/8" NPT		MC1002	MCD1002	0.76 (19.3)	1 (25.4)
	1/8" BSPT		MC1002BSPT	MCD1002BSPT	0.76 (19.3)	1 (25.4)
	1/4" NPT		MC1004	MCD1004	0.76 (19.3)	1.1 (27.9)
	1/4" BSPT			MCD1004BSPT	0.76 (19.3)	1.1 (27.9)
PANEL MOUNT FERRULELESS POLYTUBE FITTING, PTF†	5/32" OD, 0.10" ID	4.0mm OD, 2.5mm ID	MC12025	MCD12025	0.76 (19.3)	1.67 (42.4)
	1/4" OD, 0.17" ID	6.4mm OD, 4.3mm ID	MC1204	MCD1204	0.76 (19.3)	1.77 (45.0)
PANEL MOUNT HOSE BARB	1/8" ID	3.2mm ID	MC1602	MCD1602	0.76 (19.3)	1.67 (42.4)
	3/16" ID	4.8mm ID	MC1603	MCD1603	0.76 (19.3)	1.89 (48.0)
	1/4" ID	6.4mm ID	MC1604	MCD1604	0.76 (19.3)	1.89 (48.0)
PANEL MOUNT FEMALE THREAD	10-32 UNF		MC181032	MCD181032	0.76 (19.3)	1.22 (31.0)
PANEL MOUNT MALE THREAD	1/8" NPT		MC1502	MCD1502	0.76 (19.3)	1.2 (30.5)
IN-LINE FERRULELESS POLYTUBE FITTING, PTF†	1/4" OD, 0.17" ID	6.4mm OD, 4.3mm ID	MC1304	MCD1304	0.76 (19.3)	1.77 (45.0)
IN-LINE HOSE BARB	1/8" ID	3.2mm ID	MC1702	MCD1702	0.76 (19.3)	1.67 (42.4)
	3/16" ID	4.8mm ID	MC1703	MCD1703	0.76 (19.3)	1.89 (48.0)
	1/4" ID	6.4mm ID	MC1704	MCD1704	0.76 (19.3)	1.89 (48.0)

All measurements are in inches (millimeters) unless otherwise noted. Tubing must meet stated inside and outside diameters.

†NOTE: CPC's Ferruleless PTF (polytube fitting) terminations do not require ferrules to achieve a secure connection and are therefore easier to use and reuse. PTF fittings are designed for semi-rigid tubing, i.e., polyethylene, nylon, polyurethane, etc. NOTE: Elbow configurations are available. Contact CPC for more information.

PRODUCT DIMENSIONS

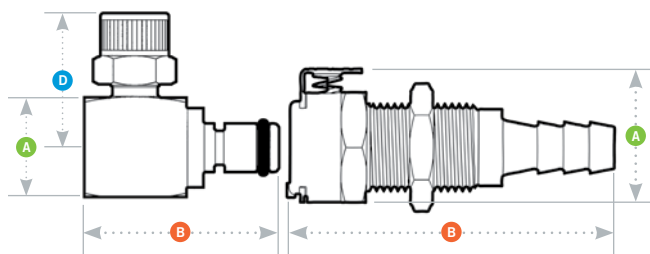







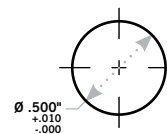

- A = Height/Diameter
- B = Total Length
- D = Elbow Radial Length

PANEL DIMENSIONS

	PANEL OPENING	PANEL THICKNESS MAX.-MIN.	PANEL NUT HEX	PANEL NUT THREAD
COUPLING BODIES (EXCEPT MALE THREAD)	see drawing	0.50 – 0.05	5/8	1/2-24UNS
MALE THREAD	see drawing	0.21 – 0.06	5/8	1/2-24UNS
COUPLING INSERTS	see drawing	0.30 – 0.06	5/8	1/2-24UNS



COUPLING INSERTS - Chrome-plated brass

TERMINATION	TUBING/THREAD SIZE	METRIC EQ	STRAIGHT THRU	SHUTOFF	A	B	D
 IN-LINE PIPE THREAD (NON-VALVED SHOWN)	1/8" NPT		MC2402	MCD2402	0.58 (14.7)	1.03/1.43 (26.2/36.3)	
	1/8" BSPT		MC2402BSPT	MCD2402BSPT	0.58/0.72 (14.7/18.3)	1.03/1.43 (26.2/36.3)	
	1/4" NPT		MC2404	MCD2404	0.65 (16.5)	1.08/1.43 (27.4/36.3)	
 IN-LINE PIPE THREAD (FEMALE)	1/8" NPT Female		MC2602	MCD2602	0.58 (14.7)	0.95/1.65 (24.1/41.9)	
	1/4" NPT Female		MC2604	MCD2604	0.72 (18.3)	1.15/1.82 (29.2/46.2)	
	1/4" BSPP Female		MC2604BSPP	MCD2604BSPP	0.72 (18.3)	1.23/1.91 (31.2/48.5)	
 PANEL MOUNT FERRULELESS POLYTUBE FITTING, PTF†	1/4" OD, 0.17" ID	6.4mm OD, 4.3mm ID	MC4004	MCD4004	0.72 (18.3)	1.75/1.85 (44.5/47.0)	
 PANEL MOUNT HOSE BARB	1/8" ID	3.2mm ID	MC4202	MCD4202	0.72 (18.3)	1.65/1.75 (41.9/44.5)	
	3/16" ID	4.8mm ID	MC4203	MCD4203	0.72 (18.3)	1.87/1.97 (47.5/50.0)	
	1/4" ID	6.4mm ID	MC4204	MCD4204	0.72 (18.3)	1.87/1.97 (47.5/50.0)	
 IN-LINE FERRULELESS POLYTUBE FITTING, PTF†	5/32" OD, 0.10" ID	4.0mm OD, 2.5mm ID	MC20025	MCD20025	0.58 (14.7)	1.13/1.53 (28.7/38.9)	
	1/4" OD, 0.17" ID	6.4mm OD, 4.3mm ID	MC2004	MCD2004	0.58 (14.7)	1.15/1.55 (29.2/39.4)	
	3/8" OD, 0.25" ID	9.5mm OD, 6.4mm ID	MC2006	MCD2006	0.58 (14.7)	1.30/1.50 (33.0/38.1)	
 IN-LINE HOSE BARB	1/8" ID	3.2mm ID	MC2202	MCD2202	0.58 (14.7)	1.05/1.65 (26.7/41.9)	
	3/16" ID	4.8mm ID	MC2203	MCD2203	0.58 (14.7)	1.25/1.85 (31.8/47.0)	
	1/4" ID	6.4mm ID	MC2204	MCD2204	0.58 (14.7)	1.25/1.67 (31.8/42.4)	
 IN-LINE FEMALE THREAD	10-32 UNF		MC281032	MCD281032	0.58 (14.7)	0.63/1.30 (16.0/33.0)	
 ELBOW FERRULELESS POLYTUBE FITTING, PTF†	5/32" OD, 0.10" ID	4.0mm OD, 2.5mm ID	MC21025	MCD21025	0.63 (16.0)	1.18/1.28 (30.0/32.5)	0.81 (20.6)
	1/4" OD, 0.17" ID	6.4mm OD, 4.3mm ID	MC2104	MCD2104	0.63 (16.0)	1.18/1.28 (30.0/32.5)	0.83 (21.1)
 ELBOW HOSE BARB	1/8" ID	3.2mm ID	MC2302	MCD2302	0.62 (15.7)	1.18/1.28 (30.0/32.5)	0.76 (19.3)
	1/4" ID	6.4mm ID	MC2304	MCD2304	0.63 (16.0)	1.18/1.28 (30.0/32.5)	0.76 (19.3)

All measurements are in inches (millimeters) unless otherwise noted. Tubing must meet stated inside and outside diameters. Couplings are pictured with valves unless otherwise noted.

†Note: CPC's Ferruleless PTF (polytube fitting) terminations do not require ferrules to achieve a secure connection and are therefore easier to use and reuse. PTF fittings are designed for semi-rigid tubing, i.e., polyethylene, nylon, polyurethane, etc. NOTE: Elbow configurations are available. Contact CPC for more information.

NSF

NSF OPTION AVAILABLE

This product has an NSF compatible product for food applications. Our food-grade couplings are superior to general fittings for fluid control because they incorporate built-in shutoff valves, enabling tubing to be disconnected without having to turn off the water supply. Scan the QR code to be taken to the NSF specific product web page.



NS212 SERIES CONNECTOR

NS212 Series couplings were built on the company's proven platform of non-spill valves designed to provide fast, safe and leak-free fluid line connections. The NS212 is an easy, twist-to-connect coupling with an integrated locking mechanism and double-sided non-spill shutoff valves. It is also chemically resistant and ideal for a diverse range of applications including printing and ink management, analytical instrumentation, electronic cooling and chemical handling. NS212 couplings provide high-flow fluid transfer in a small footprint.



SPECIFICATIONS

PRESSURE:

Vacuum to 45 psi, 3.1 bar

TEMPERATURE:

32°F to 120°F (0°C to 49°C)

MATERIALS:

Main components: Glass-filled polypropylene

Valve spring: 316 stainless steel

Seal material:

EPDM (FKM/Simriz® FFKM optional)

COLOR: Gray with black accent standard

TUBING SIZES:

1/8" and 1/4" ID, 3.2mm and 6.4mm ID

SPILLAGE: <0.025 cc/disconnect

INCLUSION: 0.009 cc/connect

WARNING: Pressure, temperature, chemicals, and operating environment can affect the performance of couplings. It is the customer's responsibility to test the suitability of CPC products in their own application conditions.



cpcworldwide.com/NS212

FEATURES

- Efficient, non-spill design → Disconnect under pressure with no spills
- Multiple seal materials → Broad chemical compatibility for diverse applications
- Twist-to-connect locking → Easy, non-spill connections in tight spaces
- Compact design → High flow in a small connector
- Ultra low air inclusion → Minimizes contaminants, reduces the need to purge lines

BENEFITS

NS212 WATER FLOW

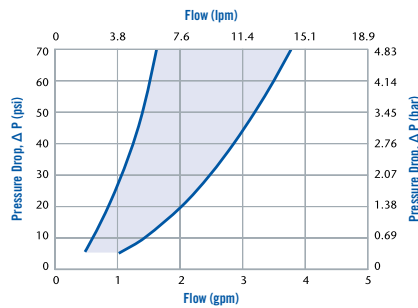



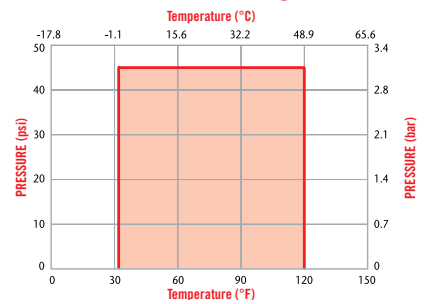

NS212 Pressure Range





These graphs are intended to give you a general idea of the performance capabilities of each product line. The shaded area of each graph represents the operating range of the product family, i.e., upper and lower values are shown. Therefore, depending on the exact coupling configurations selected, you can reasonably expect values to fall within the shaded area.

NS212 SERIES DIMENSIONS

COUPLING BODIES - Polypropylene

TERMINATION	TUBING/THREAD SIZE	METRIC EQ.	SHUTOFF	A	B
 IN-LINE PIPE THREAD	1/8" NPT		NS2D100212	0.71 (18.0)	1.74 (44.2)
 IN-LINE FERRULELESS POLYTUBE FITTING, PTF†	1/4" OD, .17 ID	6.4mm OD, 4.3mm ID	NS2D130412	0.71 (18.0)	1.87 (47.5)
 IN-LINE HOSE BARB	1/8" ID 1/4" ID	3.2mm ID 6.4mm ID	NS2D170212 NS2D170412	0.71 (18.0) 0.71 (18.0)	1.87 (47.5) 2.05 (52.1)
 PANEL MOUNT FERRULELESS POLYTUBE FITTING, PTF†	1/4" OD, .17 ID	6.4mm OD, 4.3mm ID	NS2D120412	0.88 (22.4)	1.87 (47.5)
 PANEL MOUNT HOSE BARB	1/8" ID 1/4" ID	3.2mm ID 6.4mm ID	NS2D160212 NS2D160412	0.88 (22.4) 0.88 (22.4)	1.79 (45.5) 2.05 (52.1)

COUPLING INSERTS - Polypropylene

TERMINATION	TUBING/THREAD SIZE	METRIC EQ.	SHUTOFF	A	B
 IN-LINE PIPE THREAD	1/8" NPT		NS2D240212	0.64 (16.3)	1.27 (32.3)
 IN-LINE FERRULELESS POLYTUBE FITTING, PTF†	1/4" OD, .17 ID	6.4mm OD, 4.3mm ID	NS2D200412	0.64 (16.3)	1.39 (35.3)
 IN-LINE HOSE BARB	1/8" ID 1/4" ID	3.2mm ID 6.4mm ID	NS2D220212 NS2D220412	0.64 (16.3) 0.64 (16.3)	1.32 (33.5) 1.52 (38.6)

ACCESSORIES

DESCRIPTION	MATERIAL	PART NO.
PANEL MOUNT GASKET REPLACEMENT: FOR SEALING PANEL MOUNT BODIES LISTED ABOVE	Buna-N	1830300

PRODUCT DIMENSIONS

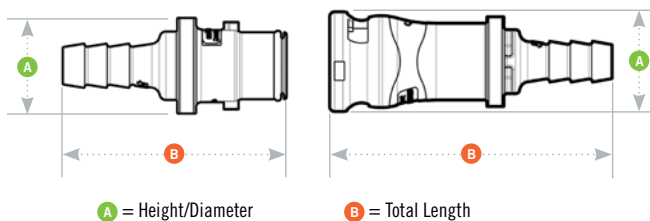

PANEL DIMENSIONS

	PANEL OPENING	PANEL THICKNESS MAX.-MIN.
COUPLING BODIES	see drawing	0.30- 0.05

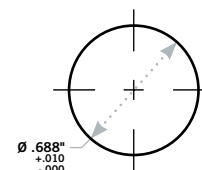

PLC[®] SERIES CONNECTOR

The 1/4" flow PLC[®] Series is proven worldwide in thousands of applications and offers the widest selection of sizes and configurations. PLC couplings are injection molded from acetal thermoplastic and are resistant to most mild chemical solutions. One-hand connection/disconnection, plus integral terminations make the PLC Series the choice for ease of use and manufacture.



SPECIFICATIONS

PRESSURE:

Vacuum to 120 psi, 8.3 bar

TEMPERATURE:

-40°F to 180° F (-40°C to 82°C)

MATERIALS:

Main components and valves: Acetal

Thumb latch: Stainless steel

Valve spring: 316 stainless steel

External springs and pin: Stainless steel

O-rings: Buna-N

COLOR: Natural white, others available

TUBING SIZES:

1/4" to 3/8" ID, 6.4mm to 9.5mm ID

JG[®] Tubing Specifications:

Tube tolerances: 1/4" OD, +0.001/-0.004 | 3/8" OD, +0.001/-0.004

Tube Types: Plastic tube: Polyethylene, nylon, polyurethane. For soft or thin wall tubing with JG[®] terminations, tube supports are recommended.

Metal tube: Brass, copper and mild steel

FEATURES

- CPC thumb latch → One-hand connection and disconnection
- Integral terminations → Fewer leak points, shorter assemblies, faster installations
- Clicks when connected → Assurance of a reliable connection
- Compatible → Mates with LC and PLC12 Series couplings

BENEFITS

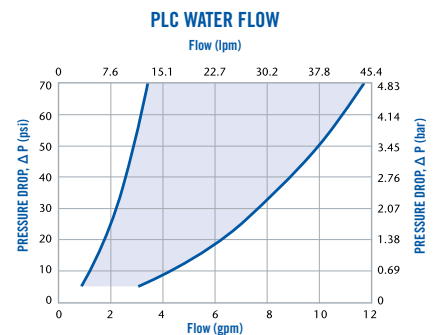
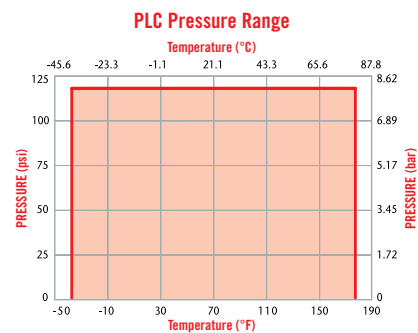
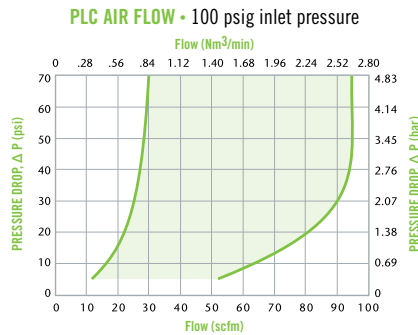

These graphs are intended to give you a general idea of the performance capabilities of each product line. The shaded area of each graph represents the operating range of the product family, i.e., upper and lower values are shown. Therefore, depending on the exact coupling configurations selected, you can reasonably expect values to fall within the shaded area.



cpcworldwide.com/PLC



NSF OPTION AVAILABLE

This product has an NSF compatible product for food applications. Our food-grade couplings are superior to general fittings for fluid control because they incorporate built-in shutoff valves, enabling tubing to be disconnected without having to turn off the water supply. Scan the QR code to be taken to the NSF specific product web page.



LIQUID FLOW RATE INFORMATION FOR COUPLINGS

The chart below shows the flow rate for CPC couplings. Each coupling was tested with water at 70°F (21°C). To determine flow rates for specific coupling configurations use the formula to the right.

$$Q = C_v \sqrt{\frac{\Delta P}{S}}$$

- Q = Flow rate in gallons per minute
- C_v = Average coefficient across various flow rates (see chart)
- ΔP = Pressure drop across coupling (psi)
- S = Specific gravity of liquid



C_v VALUES

INSERTS

	PLC 20004	PLCD 20004	PLC 20006	PLCD 20006	PLC 22004	PLCD 22004	PLC 22006	PLCD 22006	PLC 24004	PLCD 24004	PLC 24006	PLCD 24006	PLC 26004
BODIES													
PLC10004	0.40	0.36	1.05	0.58	0.83	0.56	1.40	0.82	1.40	0.75	1.40	0.77	0.83
PLCD10004	0.36	0.31	0.73	0.48	0.66	0.41	0.82	0.50	0.80	0.45	0.77	0.45	0.81
PLC10006	0.40	0.36	1.05	0.60	0.83	0.56	1.40	0.81	1.40	0.76	1.40	0.76	0.83
PLCD10006	0.37	0.31	0.81	0.47	0.70	0.43	1.02	0.51	0.98	0.46	0.99	0.48	0.98
PLC12006	0.38	0.36	0.84	0.63	0.74	0.56	1.14	0.75	1.14	0.70	1.14	0.72	0.74
PLCD12006	0.38	0.33	0.78	0.49	0.68	0.44	0.84	0.49	0.81	0.43	0.82	0.44	0.81
PLC16004	0.38	0.37	0.87	0.54	0.95	0.51	1.00	0.70	0.95	0.64	1.00	0.66	0.95
PLCD16004	0.37	0.31	0.61	0.44	0.57	0.41	0.78	0.44	0.78	0.43	0.75	0.46	0.78
PLC16006	0.38	0.37	1.00	0.57	0.95	0.53	1.40	0.80	1.40	0.71	1.40	0.73	1.40
PLCD16006	0.38	0.32	0.71	0.49	0.63	0.42	0.89	0.51	0.96	0.45	0.92	0.49	0.97

PLC® SERIES DIMENSIONS

COUPLING BODIES - Acetal

TERMINATION	TUBING/THREAD SIZE	METRIC EQ	STRAIGHT THRU	SHUTOFF	A	B
 IN-LINE PIPE THREAD	1/4" NPT		PLC10004	PLCD10004	0.9 (22.9)	1.17 (29.7)
	1/4" BSPT		PLC10004BSPT	PLCD10004BSPT	0.9 (22.9)	1.15 (29.2)
	3/8" NPT		PLC10006	PLCD10006	0.9 (22.9)	1.15 (29.2)
	3/8" BSPT		PLC10006BSPT	PLCD10006BSPT	0.9 (22.9)	1.15 (29.2)
 PANEL MOUNT FERRULELESS POLYTUBE FITTING, PTF†	1/4" OD, 0.17" ID	6.4mm OD, 4.3mm ID	PLC12004	PLCD12004	0.88 (22.4)	1.87 (47.5)
	–	8.0mm OD, 6.0mm ID	PLC120M8	PLCD120M8	0.88 (22.4)	1.95 (49.5)
	3/8" OD, 0.25" ID	9.5mm OD, 6.4mm ID	PLC12006	PLCD12006	0.88 (22.4)	1.95 (49.5)
	–	10.0mm OD, 8.0mm ID	PLC120M10	PLCD120M10	0.88 (22.4)	1.95 (49.5)
 PANEL MOUNT HOSE BARB	1/4" ID	6.4mm ID	PLC16004	PLCD16004	0.88 (22.4)	1.95 (49.5)
	5/16" ID	7.9mm ID	PLC16005	PLCD16005	0.88 (22.4)	1.95 (49.5)
	3/8" ID	9.5mm ID	PLC16006	PLCD16006	0.88 (22.4)	1.95 (49.5)
 PANEL MOUNT JG® PUSH-TO-CONNECT	1/4" OD	6.4mm OD	PLC11004	PLCD11004	0.88 (22.4)	1.95 (49.5)
 IN-LINE FERRULELESS POLYTUBE FITTING, PTF†	1/4" OD, 0.17" ID	6.4mm OD, 4.3mm ID	PLC13004	PLCD13004	0.94 (23.9)	1.82 (46.2)
	–	8.0mm OD, 6.0mm ID	PLC130M8	PLCD130M8	0.94 (23.9)	1.95 (49.5)
	3/8" OD, 0.25" ID	9.5mm OD, 6.4mm ID	PLC13006	PLCD13006	0.94 (23.9)	1.95 (49.5)
	–	10.0mm OD, 8.0mm ID	PLC130M10	PLCD130M10	0.94 (23.9)	1.95 (49.5)
 IN-LINE HOSE BARB	1/4" ID	6.4mm ID	PLC17004	PLCD17004	0.94 (23.9)	1.80/1.95 (45.7/49.5)
	5/16" ID	7.9mm ID	PLC17005	PLCD17005	0.94 (23.9)	1.95 (49.5)
	3/8" ID	9.5mm ID	PLC17006	PLCD17006	0.94 (23.9)	1.80/1.95 (45.7/49.5)
 IN-LINE JG® PUSH-TO-CONNECT	1/4" OD	6.4mm OD	PLC14004	PLCD14004	0.94 (23.9)	1.95 (49.5)
	3/8" OD	9.5mm OD	PLC14006	PLCD14006	0.94 (23.9)	2.09 (53.1)
(See page 167 for JG accessories)						

All measurements are in inches (millimeters) unless otherwise noted. Tubing must meet stated inside and outside diameters. Couplings are pictured with valves unless otherwise noted.

†NOTE: CPC's Ferruleless Polytube Fitting terminations do not require ferrules to achieve a secure connection, which makes them easier to use and reuse. PTF fittings are designed for semi-rigid tubing, i.e., polyethylene, nylon, polyurethane, etc. NOTE: JG is a registered trademark of John Guest USA, Inc.

PRODUCT DIMENSIONS

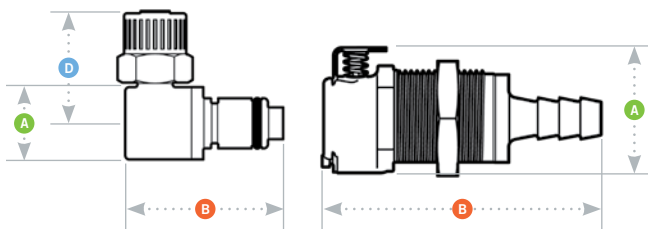







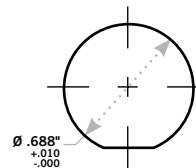

- A = Height/Diameter
- B = Total Length
- D = Elbow Radial Length

PANEL DIMENSIONS

	PANEL OPENING	PANEL THICKNESS MAX.-MIN.	PANEL NUT HEX	PANEL NUT THREAD
COUPLING BODIES	see drawing	0.50 – 0.05	13/16	11/16-24UNEF
COUPLING INSERTS	see drawing	0.30 – 0.05	13/16	11/16-24UNEF



COUPLING INSERTS - Acetal

	TERMINATION	TUBING/THREAD SIZE	METRIC EQ	STRAIGHT THRU	SHUTOFF	A	B	D
	IN-LINE PIPE THREAD	1/4" NPT		PLC24004	PLCD24004	0.72 (18.3)	1.25/1.66 (31.8/42.2)	
		1/4" BSPT		PLC24004BSPT	PLCD24004BSPT	0.72 (18.3)	1.53/1.66 (38.9/42.2)	
		3/8" NPT		PLC24006	PLCD24006	0.87 (22.1)	1.25/1.63 (31.8/41.4)	
		3/8" BSPT		PLC24006BSPT	PLCD24006BSPT	0.87 (22.1)	1.51/1.63 (38.4/41.4)	
	PANEL MOUNT FERRULELESS POLYTUBE FITTING, PTF†	1/4" OD, 0.17" ID	6.4mm OD, 4.3mm ID	PLC40004	PLCD40004	0.94 (23.9)	1.78/1.91 (45.2/48.5)	
		–	8.0mm OD, 6.0mm ID	PLC400M8	PLCD400M8	0.94 (23.9)	1.91/2.03 (48.5/51.6)	
		3/8" OD, 0.25" ID	9.5mm OD, 6.4mm ID	PLC40006	PLCD40006	0.94 (23.9)	1.91/2.05 (48.5/52.1)	
		–	10.0mm OD, 8.0mm ID	PLC400M10	PLCD400M10	0.94 (23.9)	1.91/2.05 (48.5/52.1)	
	PANEL MOUNT HOSE BARB	1/4" ID	6.4mm ID	PLC42004	PLCD42004	0.94 (23.9)	1.91/2.05 (48.5/52.1)	
		5/16" ID	7.9mm ID	PLC42005	PLCD42005	0.94 (23.9)	1.91/2.05 (48.5/52.1)	
		3/8" ID	9.5mm ID	PLC42006	PLCD42006	0.94 (23.9)	1.91/2.05 (48.5/52.1)	
	PANEL MOUNT JG® PUSH-TO- CONNECT	1/4" OD	6.4mm OD	PLC41004	PLCD41004	0.94 (23.9)	1.91/2.05 (48.5/52.1)	
	IN-LINE FERRULELESS POLYTUBE FITTING, PTF†	1/4" OD, 0.17" ID	6.4mm OD, 4.3mm ID	PLC20004	PLCD20004	0.72 (18.3)	1.25/1.88 (31.8/73.2)	
		–	8.0mm OD, 6.0mm ID	PLC200M8	PLCD200M8	0.72 (18.3)	1.38/1.82 (35.1/46.2)	
		3/8" OD, 0.25" ID	9.5mm OD, 6.4mm ID	PLC20006	PLCD20006	0.72 (18.3)	1.38/1.82 (35.1/46.2)	
		–	10.0mm OD, 8.0mm ID	PLC200M10	PLCD200M10	0.72 (18.3)	1.38/1.82 (35.1/46.2)	
	IN-LINE HOSE BARB	1/4" ID	6.4mm ID	PLC22004	PLCD22004	0.62 (15.7)	1.35/1.99 (34.3/50.6)	
		5/16" ID	7.9mm ID	PLC22005	PLCD22005	0.62 (15.7)	1.35/1.99 (34.3/50.6)	
		3/8" ID	9.5mm ID	PLC22006	PLCD22006	0.62 (15.7)	1.36/1.81 (34.5/46.0)	
	IN-LINE JG® PUSH-TO- CONNECT	1/4" OD	6.4mm OD	PLC29004	PLCD29004	0.62 (15.7)	1.35/1.95 (34.3/49.5)	
		3/8" OD	9.5mm OD	PLC29006	PLCD29006	0.78 (19.8)	1.51/2.11 (38.4/53.6)	
	ELBOW FERRULELESS POLYTUBE FITTING, PTF†	3/8" OD, 0.25" ID	9.5mm OD, 6.4mm ID	PLC21006	PLCD21006	.61/.62 (15.45/15.8)	1.22/1.35 (31.0/34.3)	0.85/0.96 (21.6/24.4)
	ELBOW HOSE BARB	1/4" ID	6.4mm ID	PLC23004	PLCD23004	.67/.63 (17.0/16.0)	1.10/1.28 (27.9/32.5)	0.85/0.96 (21.6/24.4)
		3/8" ID	9.5mm ID	PLC23006	PLCD23006	.67/.63 (17.0/16.0)	1.25/1.28 (31.8/32.5)	0.90/0.96 (22.9/24.4)

All measurements are in inches (millimeters) unless otherwise noted. Tubing must meet stated inside and outside diameters. Couplings are pictured with valves unless otherwise noted.

†NOTE: CPC's Ferruleless Polytube Fitting terminations do not require ferrules to achieve a secure connection, which makes them easier to use and reuse. PTF fittings are designed for semi-rigid tubing, i.e., polyethylene, nylon, polyurethane, etc. NOTE: JG is a registered trademark of John Guest USA, Inc.

DTLD SERIES CONNECTOR

The 1/4" flow DTLD Series dual flow couplings provide a unique thumb latch that enables independent connection and simultaneous disconnection of loose tube sets. Made from ABS thermoplastic, the DTLD valved couplings prevent one tube inadvertently disconnecting when the other is inserted. One-hand operation makes the DTLD Series the choice for simple, independent quick connections of dual fluid lines. The DTLD Series is compatible with all PLC, PLC12 and LC Series inserts.



SPECIFICATIONS

PRESSURE:

Vacuum to 20 psi, 1.38 bar

TEMPERATURE:

32°F to 120°F (0°C to 48°C)

MATERIALS:

- Main components:** ABS
- Thumb latch:** Acetal
- Internal body valve:** Acetal
- Internal insert valve:** Polypropylene
- Springs:** Stainless steel
- O-rings:** Buna-N

COLOR: White with blue latch,
Molded black with gray latch

TUBING SIZES:

1/4" to 3/8" ID, 6.4mm to 9.5mm ID

WARNING: Pressure, temperature, chemicals, and operating environment can affect the performance of couplings. It is the customer's responsibility to test the suitability of CPC products in their own application conditions.



cpcworldwide.com/DTLD

FEATURES

- Shrouded thumb latch → Minimizes inadvertent latch activation
- Latch always in position to accept insert → Ensures leak-free operation
- Compact, modular design → Fits well in the hand and is easy to wipe down
- Independent quick connections → Requires minimal manual dexterity

BENEFITS

DTLD WATER FLOW

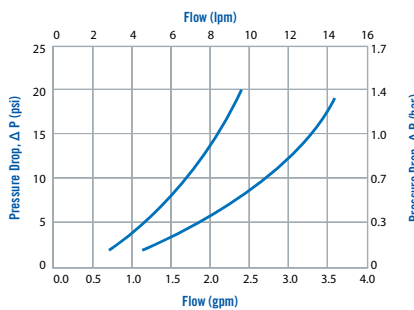

DTLD Pressure Range

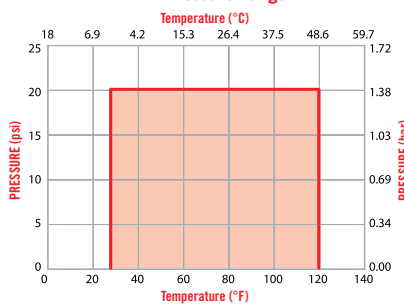

← These graphs are intended to give you a general idea of the performance capabilities of each product line. The shaded area of each graph represents the operating range of the product family, i.e., upper and lower values are shown. Therefore, depending on the exact coupling configurations selected, you can reasonably expect values to fall within the shaded area.

DTLD SERIES DIMENSIONS

COUPLING BODIES - ABS



TERMINATION	TUBING/THREAD SIZE	METRIC EQ.	SHUTOFF	A	B	C	D
IN-LINE HOSE BARB	1/4" ID	6.4mm ID	DTLD17004	1.59 (40.4)	2.02 (51.3)	0.75 (19.1)	1 (25.4)
	1/4" ID	6.4mm ID	DTLD17004MBLK	1.59 (40.4)	2.02 (51.3)	0.75 (19.1)	1 (25.4)
	3/8" ID	9.5mm ID	DTLD17006	1.59 (40.4)	1.86 (47.2)	0.75 (19.1)	1 (25.4)
	3/8" ID	9.5mm ID	DTLD17006MBLK	1.59 (40.4)	1.86 (47.2)	0.75 (19.1)	1 (25.4)

COUPLING INSERTS - ABS



TERMINATION	TUBING/THREAD SIZE	METRIC EQ.	SHUTOFF	A	B	C	D
IN-LINE HOSE BARB	1/4" ID	6.4mm ID	PLCD2200406	0.73 (18.5)	1.85 (47.0)		
	1/4" ID	6.4mm ID	PLCD2200406MBLK	0.73 (18.5)	1.85 (47.0)		
	3/8" ID	9.5mm ID	PLCD2200606	0.73 (18.5)	1.69 (42.9)		
	3/8" ID	9.5mm ID	PLCD2200606MBLK	0.73 (18.5)	1.69 (42.9)		

All measurements are in inches (millimeters) unless otherwise noted. Tubing must meet stated inside and outside diameters. PTF fittings are designed for semi-rigid tubing, i.e., polyethylene, nylon, polyurethane, etc.

*NOTE: CPC's Ferruleless PTF (polytube fitting) terminations do not require ferrules to achieve a secure connection and are therefore easier to use and reuse.

PRODUCT DIMENSIONS

Body Sideview

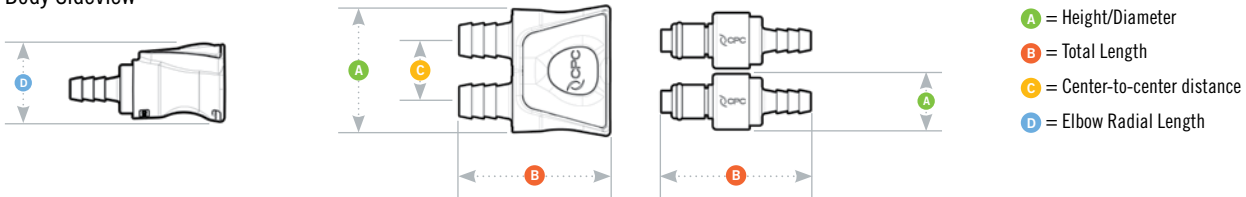

PLC12 SERIES CONNECTOR

The 1/4" flow polypropylene PLC12 offers many of the same configuration options as the PLC. The polypropylene material adds greater chemical resistance for more demanding applications. PLC12 couplings are also gamma sterilizable. PLC12 couplings are also gamma sterilizable and available with optional RFID (Radio Frequency Identification) capability (see page 118).



SPECIFICATIONS

PPRESSURE:

Vacuum to 120 psi, 8.3 bar

TEMPERATURE:

32°F to 160°F (0°C to 71°C)

MATERIALS:

Main components and valves:
Polypropylene

Thumb latch: Stainless steel

Valve spring: 316 stainless steel

External springs and pin: Stainless steel

O-rings: EPDM

STERILIZATION:

Gamma: Up to 50 kGy irradiation

COLOR:

Almond

TUBING SIZES:

1/4" to 3/8" ID, 6.4mm to 9.5mm ID

WARNING: Pressure, temperature, chemicals, and operating environment can affect the performance of couplings. It is the customer's responsibility to test the suitability of CPC's products in their own application conditions. Use the graph at the right as a guide.



cpcworldwide.com/PLC12

FEATURES

- Polypropylene material → Chemically resistant and gamma sterilizable
- EPDM o-rings → Greater chemical resistance
- CPC thumb latch → One-hand connection and disconnection
- Integral terminations → Fewer leak points, shorter assemblies, faster installations

BENEFITS



DID YOU KNOW

PLC12 Couplings are gamma sterilizable; see page 168 for more information on sterilization and disinfection.

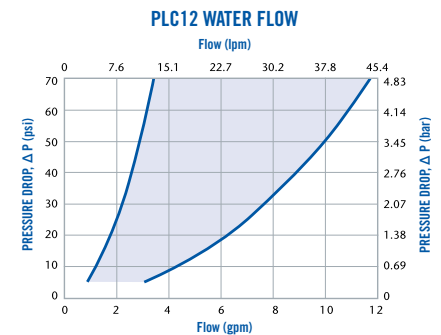
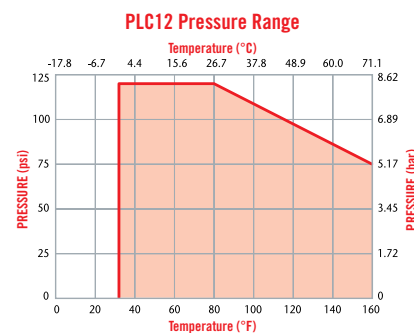
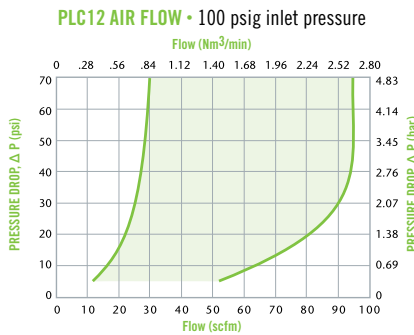

These graphs are intended to give you a general idea of the performance capabilities of each product line. The shaded area of each graph represents the operating range of the product family, i.e., upper and lower values are shown. Therefore, depending on the exact coupling configurations selected, you can reasonably expect values to fall within the shaded area.



WHEN TO CONSIDER A CUSTOM PROJECT:

- A quick disconnect will add value to product, make it easier to use and more reliable
- Your specification cannot be met by an existing standard CPC product
- Unique requirements, budgets or timing warrant a conversation with CPC

LIQUID FLOW RATE INFORMATION FOR COUPLINGS

The chart below shows the flow rate for CPC couplings. Each coupling was tested with water at 70°F (21°C). To determine flow rates for specific coupling configurations use the formula to the right.

$$Q = C_v \sqrt{\frac{\Delta P}{S}}$$

Q = Flow rate in gallons per minute
 C_v = Average coefficient across various flow rates (see chart)
 ΔP = Pressure drop across coupling (psi)
 S = Specific gravity of liquid

C_v VALUES





INSERTS

BODIES

	PLC 2000412	PLCD 2000412	PLC 2000612	PLCD 2000612	PLC 2200412	PLCD 2200412	PLC 2200612	PLCD 2200612	PLC 2400412	PLCD 2400412	PLC 2400612	PLCD 2400612	PLC 2600412
PLC1000412	0.40	0.36	1.05	0.58	0.83	0.56	1.40	0.82	1.40	0.75	1.40	0.77	0.83
PLCD1000412	0.36	0.31	0.73	0.48	0.66	0.41	0.82	0.50	.80	0.45	0.77	0.45	0.81
PLC1000612	0.40	0.36	1.05	0.60	0.83	0.56	1.40	0.81	1.40	0.76	1.40	0.76	0.83
PLCD1000612	0.37	0.31	0.81	0.47	0.70	0.43	1.02	0.51	0.98	0.46	0.99	0.48	0.98
PLC1200612	0.38	0.36	0.84	0.63	0.74	0.56	1.14	0.75	1.14	0.70	1.14	0.72	0.74
PLCD1200612	0.38	0.33	0.78	0.49	0.68	0.44	0.84	0.49	0.81	0.43	0.82	0.44	0.81
PLC1600412	0.38	0.37	0.87	0.54	0.95	0.51	1.00	0.70	0.95	0.64	1.00	0.66	0.95
PLCD1600412	0.37	0.31	0.61	0.44	0.57	0.41	0.78	0.44	0.78	0.43	0.75	0.46	0.78
PLC1600612	0.38	0.37	1.00	0.57	0.95	0.53	1.40	0.80	1.40	0.71	1.40	0.73	1.40
PLCD1600612	0.38	0.32	0.71	0.49	0.63	0.42	0.89	0.51	0.96	0.45	0.92	0.49	0.97

PLC12 SERIES DIMENSIONS

COUPLING BODIES - Polypropylene

TERMINATION	TUBING/THREAD SIZE	METRIC EQ	STRAIGHT THRU	SHUTOFF	A	B
 IN-LINE PIPE THREAD	1/4" NPT		PLC1000412	PLCD1000412	1 (25.4)	1.15 (29.2)
	1/4" BSPT		PLC1000412BSPT	PLCD1000412BSPT	1 (25.4)	1.15 (29.2)
	3/8" NPT		PLC1000612	PLCD1000612	1 (25.4)	1.15 (29.2)
	3/8" BSPT		PLC1000612BSPT	PLCD1000612BSPT	1 (25.4)	1.15 (29.2)
 PANEL MOUNT FERRULELESS POLYTUBE FITTING, PTF†	3/8" OD, 1/4" ID	9.5mm OD, 6.4mm ID	PLC1200612	PLCD1200612	1 (25.4)	1.95 (49.5)
 PANEL MOUNT HOSE BARB	1/4" ID	6.4mm ID	PLC1600412	PLCD1600412	1 (25.4)	1.95 (49.5)
	3/8" ID	9.5mm ID	PLC1600612	PLCD1600612	1 (25.4)	1.95 (49.5)
 IN-LINE FERRULELESS POLYTUBE FITTING, PTF†	3/8" OD, 1/4" ID	9.5mm OD, 6.4mm ID	PLC1300612	PLCD1300612	1.02 (25.9)	1.96 (49.8)
 IN-LINE HOSE BARB	1/4" ID	6.4mm ID	PLC1700412	PLCD1700412	1.02 (25.9)	1.96 (49.8)
	3/8" ID	9.5mm ID	PLC1700612	PLCD1700612	1.02 (25.9)	1.96 (49.8)

COUPLING READERS - Polypropylene

TERMINATION	TUBING/THREAD SIZE	METRIC EQ	STRAIGHT THRU	SHUTOFF	A	B
 IN-LINE HOSE BARB (RS-232 INTERFACE)	1/4" ID	6.4mm ID		iPLCDR1700400	1.39 (35.3)	2.78 (70.6)
	3/8" ID	9.5mm ID		iPLCDR1700600	1.39 (35.3)	2.78 (70.6)
IN-LINE HOSE BARB (USB INTERFACE)	3/8" ID	9.5mm ID		iPLCDR1700601	1.05 (26.7)	1.74/1.87 (44.2/47.5)

All measurements are in inches (millimeters) unless otherwise noted. Tubing must meet stated inside and outside diameters. †NOTE: CPC's Ferruleless Polytube Fitting terminations do not require ferrules to achieve a secure connection, which makes them easier to use and reuse. PTF fittings are designed for semi-rigid tubing, i.e., polyethylene, nylon, polyurethane, etc. NOTE: JG is a registered trademark of John Guest USA, Inc.

PRODUCT DIMENSIONS

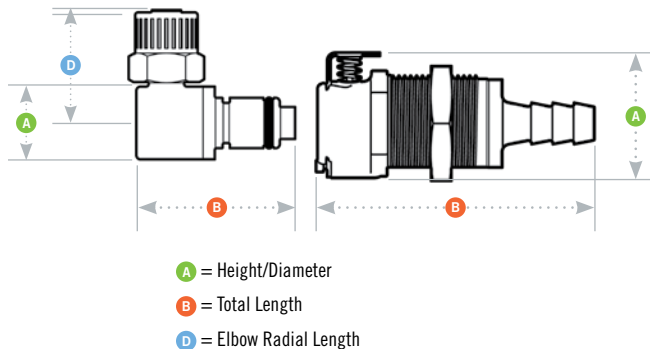





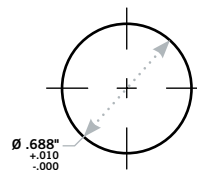



PANEL DIMENSIONS

	PANEL OPENING	PANEL THICKNESS MAX.-MIN.	PANEL NUT HEX	PANEL NUT THREAD
COUPLING BODIES	see drawing	0.30 – 0.02	13/16	11/16-24UNEF
COUPLING INSERTS	see drawing	0.30 – 0.02	13/16	11/16-24UNEF



COUPLING INSERTS - Acetal

	TERMINATION	TUBING/THREAD SIZE	METRIC EQ	STRAIGHT THRU	SHUTOFF	A	B	D
	IN-LINE PIPE THREAD	1/4" NPT		PLC2400412	PLCD2400412	0.72 (18.3)	1.26/1.67 (32.0/42.4)	
	PANEL MOUNT HOSE BARB	1/4" ID 3/8" ID	6.4mm ID 9.5mm ID	PLC4200412 PLC4200612	PLCD4200412 PLCD4200612	0.94 (23.9) 0.94 (23.9)	1.91/2.05 (48.5/52.1) 1.91/2.05 (48.5/52.1)	
	IN-LINE FERRULELESS POLYTUBE FITTING, PTF†	3/8" OD, 1/4" ID -	9.5mm OD, 6.4mm ID 8.0mm ID	PLC2000612	PLCD2000612 PLCD200M812	0.72 (18.3) 0.72 (18.3)	1.68/1.82 942.7/46.2) 1.82 (46.2)	
	IN-LINE HOSE BARB	1/4" ID 3/8" ID	6.4mm ID 9.5mm ID	PLC2200412 PLC2200612	PLCD2200412 PLCD2200612	0.63 (16.0) 0.63 (16.0)	1.35/2.00 (34.3/50.8) 1.35/1.82 (34.3/46.2)	
	ELBOW FERRULELESS POLYTUBE FITTING, PTF†	3/8" OD, 1/4" ID	9.5mm OD, 6.4mm ID	PLC2100612	PLCD2100612	0.61/0.62 (15.5/15.8)	1.29/1.36 (32.8/34.5)	0.96 (24.4)
	ELBOW HOSE BARB	(RS-232 Interface) 3/8" ID	6.4mm ID 9.5mm ID	PLC2300412 PLC2300612	PLCD2300412 PLCD2300612	0.63 (16.0) 0.63 (16.0)	1.22/1.36 (31.0/34.5) 1.28/1.42 (32.5/36.1)	0.96 (24.4) 0.96 (24.4)
	IN-LINE HOSE BARB	1/4" ID	6.4mm ID	iPLCT2200400	iPLCDT2200400	1.39 (35.3)	2.78 (70.6)	
	ELBOW HOSE BARB (RS-232 INTERFACE)	1/4" ID 3/8" ID	6.4mm ID 9.5mm ID		iPLCDT2300400 iPLCDT2300600	1.48 (37.6) 1.48 (37.6)	1.27/1.40 (32.3/35.6) 1.33/1.46 (33.8/37.1)	

All measurements are in inches (millimeters) unless otherwise noted. Tubing must meet stated inside and outside diameters. Couplings are pictured with valves unless otherwise noted.

†NOTE: CPC's Ferruleless Polytube Fitting terminations do not require ferrules to achieve a secure connection, which makes them easier to use and reuse. PTF fittings are designed for semi-rigid tubing, i.e., polyethylene, nylon, polyurethane, etc. NOTE: JG is a registered trademark of John Guest USA, Inc.

LC SERIES CONNECTOR

CPC's LC Series chrome-plated brass couplings are built tough and made to last in the most demanding applications. Ideal for use with higher temperature or pressure, the LC Series features a one-hand operation for swift and easy connects and disconnects. These couplings offer the flexibility of multiple configurations and terminations to mate with both the PLC acetal and PLC12 polypropylene couplings.



SPECIFICATIONS

PRESSURE:

Vacuum to 250 psi, 17.3 bar

TEMPERATURE:

-40°F to 180°F (-40°C to 82°C)
(High temperature versions available with ratings to 400°F)

MATERIALS:

- Main components:** Chrome-plated brass
- Thumb latch:** Stainless steel
- Valves:** Acetal
- Valve springs:** 316 stainless steel
- External springs and pin:** Stainless steel
- O-rings:** Buna-N

FINISH:

TUBING SIZES:

1/4" to 3/8" ID, 6.4mm to 9.5mm ID

WARNING: Pressure, temperature, chemicals, and operating environment can affect the performance of couplings. It is the customer's responsibility to test the suitability of CPC products in their own application conditions.



cpcworldwide.com/LC

FEATURES

- Brass material → Durable construction withstands higher pressure and temperature
- Chrome plating → Attractive appearance
- High temperature capability → Versions rated to 400°F (204°C)
- CPC thumb latch → One-hand connection and disconnection
- Compatible → LC mates with PLC and PLC 12 Series couplings

BENEFITS

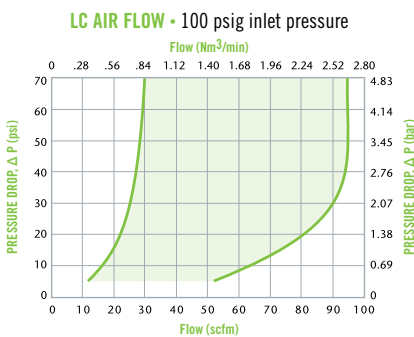
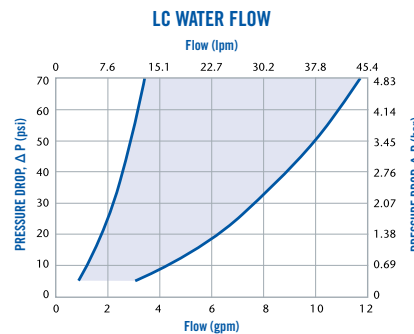

These graphs are intended to give you a general idea of the performance capabilities of each product line. The shaded area of each graph represents the operating range of the product family, i.e., upper and lower values are shown. Therefore, depending on the exact coupling configurations selected, you can reasonably expect values to fall within the shaded area.

DID YOU KNOW

O-ring selection is a key decision in determining which connector will perform best in your specific application. Understanding the material characteristics and how they can be affected by both the media being transferred and the environment in which the connector is being used is important.

NOTE

High temperature versions available with ratings to 400 F. Call customer service for more information.

NSF

NSF OPTION AVAILABLE

This product has an NSF compatible product for food applications. Our food-grade couplings are superior to general fittings for fluid control because they incorporate built-in shutoff valves, enabling tubing to be disconnected without having to turn off the water supply. Scan the QR code to be taken to the NSF specific product web page.



LIQUID FLOW RATE INFORMATION FOR COUPLINGS

The chart below shows the flow rate for CPC couplings. Each coupling was tested with water at 70°F (21°C). To determine flow rates for specific coupling configurations use the formula to the right.

$$Q = C_v \sqrt{\frac{\Delta P}{S}}$$

- Q = Flow rate in gallons per minute
- C_v = Average coefficient across various flow rates (see chart)
- ΔP = Pressure drop across coupling (psi)
- S = Specific gravity of liquid







C_v VALUES

INSERTS

BODIES	INSERTS													
	LC 20004	LCD 20004	LC 20006	LCD 20006	LC 22004	LCD 22004	LC 22006	LCD 22006	LC 24004	LCD 24004	LC 24006	LCD 24006	LC 26004	
LC10004	0.40	0.36	1.05	0.58	0.83	0.56	1.40	0.82	1.40	0.75	1.40	0.77	0.83	
LCD10004	0.36	0.31	0.73	0.48	0.66	0.41	0.82	0.50	0.80	0.45	0.77	0.45	0.81	
LC10006	0.40	0.36	1.05	0.60	0.83	0.56	1.40	0.81	1.40	0.76	1.40	0.76	0.83	
LCD10006	0.37	0.31	0.81	0.47	0.70	0.43	1.02	0.51	0.98	0.46	0.99	0.48	0.98	
LC12006	0.38	0.36	0.84	0.63	0.74	0.56	1.14	0.75	1.14	0.70	1.14	0.72	0.74	
LCD12006	0.38	0.33	0.78	0.49	0.68	0.44	0.84	0.49	0.81	0.43	0.82	0.44	0.81	
LC16004	0.38	0.37	0.87	0.54	0.95	0.51	1.00	0.70	0.95	0.64	1.00	0.66	0.95	
LCD16004	0.37	0.31	0.61	0.44	0.57	0.41	0.78	0.44	0.78	0.43	0.75	0.46	0.78	
LC16006	0.38	0.37	1.00	0.57	0.95	0.53	1.40	0.80	1.40	0.71	1.40	0.73	1.40	
LCD16006	0.38	0.32	0.71	0.49	0.63	0.42	0.89	0.51	0.96	0.45	0.92	0.49	0.97	

LC SERIES DIMENSIONS

COUPLING BODIES - Chrome-plated brass

TERMINATION	TUBING/THREAD SIZE	METRIC EQ	STRAIGHT THRU	SHUTOFF	A	B
 IN-LINE PIPE THREAD	1/4" NPT		LC10004	LCD10004	0.88 (22.4)	1.15 (29.2)
	1/4" BSPT		LC10004BSPT	LCD10004BSPT	0.88 (22.4)	1.15 (29.2)
	3/8" NPT		LC10006	LCD10006	0.88 (22.4)	1.15 (29.2)
	3/8" BSPT		LC10006BSPT	LCD10006BSPT	0.88 (22.4)	1.15 (29.2)
 PANEL MOUNT FERRULELESS POLYTUBE FITTING, PTF†	1/4" OD, 0.17" ID	6.4mm OD, 4.3mm ID	LC12004	LCD12004	0.88 (22.4)	1.87 (47.5)
	3/8" OD, 1/4" ID	9.5mm OD, 6.4mm ID	LC12006	LCD12006	0.88 (22.4)	2 (50.8)
 PANEL MOUNT HOSE BARB	1/4" ID	6.4mm ID	LC16004	LCD16004	0.88 (22.4)	2 (50.8)
	5/16" ID	7.9mm ID	LC16005	LCD16005	0.88 (22.4)	2 (50.8)
	3/8" ID	9.5mm ID	LC16006	LCD16006	0.88 (22.4)	2 (50.8)
 PANEL MOUNT MALE THREAD	1/4" NPT		LC15004	LCD15004	0.88 (22.4)	1.5 (38.1)
 IN-LINE FERRULELESS POLYTUBE FITTING, PTF†	1/4" OD, 0.17" ID	6.4mm OD, 4.3mm ID	LC13004	LCD13004	0.88 (22.4)	1.87 (47.5)
	3/8" OD, 1/4" ID	9.5mm OD, 6.4mm ID	LC13006	LCD13006	0.88 (22.4)	2 (50.8)
 IN-LINE HOSE BARB	1/4" ID	6.4mm ID	LC17004	LCD17004	0.88 (22.4)	2 (50.8)
	5/16" ID	7.9mm ID	LC17005	LCD17005	0.88 (22.4)	2 (50.8)
	3/8" ID	9.5mm ID	LC17006	LCD17006	0.88 (22.4)	2 (50.8)

All measurements are in inches (millimeters) unless otherwise noted. Tubing must meet stated inside and outside diameters.

†NOTE: CPC's Ferruleless PTF (polytube fitting) terminations do not require ferrules to achieve a secure connection and are therefore easier to use and reuse. PTF fittings are designed for semi-rigid tubing, i.e., polyethylene, nylon, polyurethane, etc. NOTE: Elbow configurations are available. Contact CPC for more information.

PRODUCT DIMENSIONS

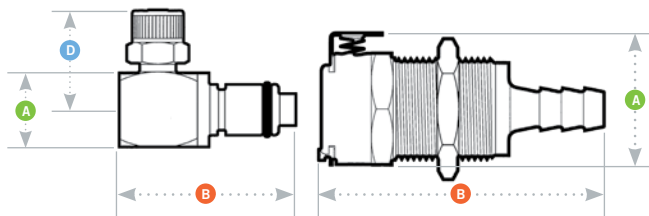







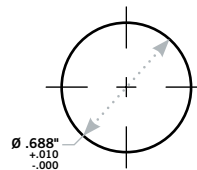

- A = Height/Diameter
- B = Total Length
- D = Elbow Radial Length

PANEL DIMENSIONS

	PANEL OPENING	PANEL THICKNESS MAX.-MIN.	PANEL NUT HEX	PANEL NUT THREAD
COUPLING BODIES	see drawing	0.50 - 0.05	13/16	11/16-24UNEF
COUPLING INSERTS	see drawing	0.090 - 0.300	13/16	11/16-24UNEF



COUPLING INSERTS - Chrome-plated brass

	TERMINATION	TUBING/THREAD SIZE	METRIC EQ	STRAIGHT THRU	SHUTOFF	A	B	D
	IN-LINE PIPE THREAD	1/4" NPT		LC24004	LCD24004	0.72 (18.3)	1.25/1.68 (31.8/42.7)	
		1/4" BSPT		LC24004BSPT	LCD24004BSPT	0.72 (18.3)	1.25/1.68 (31.8/42.7)	
		3/8" NPT		LC24006	LCD24006	0.87 (22.1)	1.25/1.55 (31.8/39.4)	
		3/8" BSPT		LC24006BSPT	LCD24006BSPT	0.87 (22.1)	1.25/1.55 (31.8/39.4)	
	IN-LINE PIPE THREAD (FEMALE)	1/4" NPT Female		LC26004	LCD26004	0.72 (18.3)	1.25/1.90 (31.8/48.3)	
		1/4" BSPP Female		LC26004BSPP	LCD26004BSPP	0.72 (18.3)	1.25/1.75 (31.8/44.5)	
	PANEL MOUNT FERRULELESS POLYTUBE FITTING, PTF†	1/4" OD, 0.17" ID	6.4mm OD, 4.3mm ID	LC40004	LCD40004	0.94 (23.9)	1.83/1.98 (46.5/50.3)	
		3/8" OD, 1/4" ID	9.5mm OD, 6.4mm ID	LC40006	LCD40006	0.94 (23.9)	1.96/2.11 (47.8/53.6)	
	PANEL MOUNT HOSE BARB	1/4" ID	6.4mm ID	LC42004	LCD42004	0.94 (23.9)	1.96/2.11 (47.8/53.6)	
		5/16" ID	7.9mm ID	LC42005	LCD42005	0.94 (23.9)	1.96/2.11 (47.8/53.6)	
		3/8" ID	9.5mm ID	LC42006	LCD42006	0.94 (23.9)	1.96/2.11 (47.8/53.6)	
	IN-LINE FERRULELESS POLYTUBE FITTING, PTF†	1/4" OD, 0.17" ID	6.4mm OD, 4.3mm ID	LC20004	LCD20004	0.72 (18.3)	1.25/1.87 (31.8/47.5)	
		3/8" OD, 1/4" ID	9.5mm OD, 6.4mm ID	LC20006	LCD20006	0.72 (18.3)	1.38/1.83 (1.4/35.1)	
	IN-LINE HOSE BARB	1/4" ID	6.4mm ID	LC22004	LCD22004	0.63 (16.0)	1.35/2.00 (34.3/50.8)	
		5/16" ID	7.9mm ID	LC22005	LCD22005	0.63 (16.0)	1.35/1.85 (34.3/47.0)	
		3/8" ID	9.5mm ID	LC22006	LCD22006	0.63 (16.0)	1.35/1.83 (34.3/35.1)	
	ELBOW FERRULELESS POLYTUBE FITTING, PTF†	1/4" OD, 0.17" ID	6.4mm OD, 4.3mm ID	LC21004	LCD21004	0.63 (16.0)	1.28/1.43 (32.5/36.3)	0.83 (21.1)
		3/8" OD, 1/4" ID	9.5mm OD, 6.4mm ID	LC21006	LCD21006	0.63 (16.0)	1.28/1.43 (32.5/36.3)	0.96 (24.4)
	ELBOW HOSE BARB	1/4" ID	6.4mm ID	LC23004	LCD23004	0.63/0.62	1.28/1.43 (32.5/36.3)	1.28 (32.5)
		3/8" ID	9.5mm ID	LC23006	LCD23006	0.63/0.62	1.28/1.43 (32.5/36.3)	1.28 (32.5)

All measurements are in inches (millimeters) unless otherwise noted. Tubing must meet stated inside and outside diameters. Couplings are pictured with valves unless otherwise noted.

†Note: CPC's Ferruleless PTF (polytube fitting) terminations do not require ferrules to achieve a secure connection and are therefore easier to use and reuse. PTF fittings are designed for semi-rigid tubing, i.e., polyethylene, nylon, polyurethane, etc. NOTE: Elbow configurations are available. Contact CPC for more information.

APC SERIES CONNECTOR

The 1/4" flow APC Series couplings feature a plastic thumb latch, fewer moving parts and a smooth contoured design to deliver ease-of-use and excellent flow in a compact size. The APC Series includes couplings with valves and thumb latch shrouds. A more rugged design on some models adds durability to increase the APC's application range.



SPECIFICATIONS

PRESSURE:

Vacuum to 120 psi, 8.3 bar

TEMPERATURE:

-40°F to 180°F (-40°C to 82°C)

MATERIALS:

Main components and valves: Acetal

Thumb latch: Acetal

Valve spring: 316 stainless steel

External springs and pin: Stainless steel

O-rings: Buna-N

COLOR:

Natural white, others available

TUBING SIZES:

1/16" to 1/4" ID, 1.6mm to 6.4mm ID

WARNING: Pressure, temperature, chemicals, and operating environment can affect the performance of couplings. It is the customer's responsibility to test the suitability of CPC products in their own application conditions.



cpcworldwide.com/APC

FEATURES

Plastic thumb latch



BENEFITS

No exposed metal parts

Shrouded thumb latch



Protects against accidental disconnects

Integral terminations



Fewer leak points, shorter assemblies, faster installations

Compatibility



Mates with most EFC couplings

APC WATER FLOW

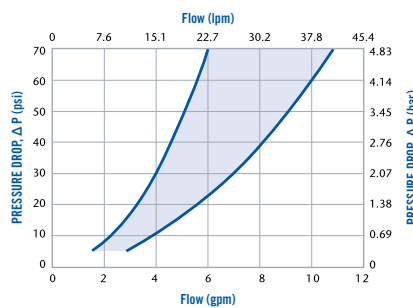

APC AIR FLOW • 100 psig inlet pressure

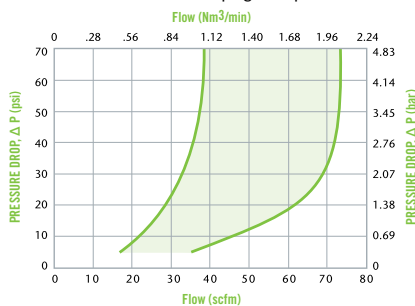

These graphs are intended to give you a general idea of the performance capabilities of each product line. The shaded area of each graph represents the operating range of the product family, i.e., upper and lower values are shown. Therefore, depending on the exact coupling configurations selected, you can reasonably expect values to fall within the shaded area.

DID YOU KNOW

The shelf life of a connector is dependent upon the connector materials and the storage conditions. CPC manufactures quick disconnect couplings and connections made from a variety of metal, plastic and elastomeric raw materials. In general, it is best to store any CPC product in an environment shielded from light at a temperature between 50°F and 90°F.

The shelf life of CPC couplings and connections is estimated to be 3 years minimum if the storage conditions comply with those shown above.

Note: For product containing lubricated o-rings, the lubricant will dry out over time. Prior to use, it may be advisable to re-lubricate external o-rings. For product containing silicone o-rings, if lube is allowable, use of a synthetic lube is recommended.



NSF OPTION AVAILABLE

This product has an NSF compatible product for food applications. Our food-grade couplings are superior to general fittings for fluid control because they incorporate built-in shutoff valves, enabling tubing to be disconnected without having to turn off the water supply. Scan the QR code to be taken to the NSF specific product web page.



LIQUID FLOW RATE INFORMATION FOR COUPLINGS

The chart below shows the flow rate for CPC couplings. Each coupling was tested with water at 70°F (21°C). To determine flow rates for specific coupling configurations use the formula to the right.

$$Q = C_v \sqrt{\frac{\Delta P}{S}}$$

- Q = Flow rate in gallons per minute
- C_v = Average coefficient across various flow rates (see chart)
- ΔP = Pressure drop across coupling (psi)
- S = Specific gravity of liquid







C_v VALUES

INSERTS

	APC 20004	APCD 20004	APC 20006	APCD 20006	APC 22004	APCD 22004	APC 22006	APCD 22006	APC 24004	APCD 24004	APC 24006	APCD 24006
BODIES												
APC10004	0.4	0.4	1.2	0.9	1.0	0.9	2.0	0.9	1.9	0.8	1.7	0.8
APCD10004	0.36	0.4	1.0	0.7	1.0	0.7	0.8	0.7	1.2	0.6	0.8	0.6
APC10006	0.4	0.4	1.2	0.9	1.2	0.7	1.8	0.9	2.0	0.9	1.7	0.8
APCD10006	0.37	0.4	1.3	0.8	0.6	0.5	1.1	0.7	1.3	0.7	1.0	0.7
APC13004SH	0.38	0.5	0.5	0.4	0.4	0.4	0.5	0.4	0.5	0.4	0.4	0.4
APCD13004SH	0.38	0.5	0.4	0.4	0.4	0.4	0.4	0.4	0.4	0.4	0.4	0.4
APC13006SH	0.38	0.4	1.0	0.7	0.9	0.6	1.1	0.7	1.1	0.7	1.0	0.7
APCD13006SH	0.37	0.4	0.8	0.6	0.7	0.5	0.8	0.6	0.9	0.6	0.8	0.6
APC17004SH	0.38	0.4	0.8	0.6	1.0	0.7	0.9	0.7	0.8	0.6	0.7	0.6
APCD17004SH	0.38	0.4	0.7	0.5	0.8	0.6	0.7	0.6	0.7	0.5	0.6	0.5
APC17006SH	0.4	0.4	1.2	0.9	1.4	0.9	1.4	0.9	2.0	0.9	1.9	0.8
APCD17006SH	0.4	0.4	1.2	0.8	1.3	0.8	1.2	0.7	1.2	0.7	1.1	0.7

APC SERIES DIMENSIONS

COUPLING BODIES - Acetal

TERMINATION	TUBING/THREAD SIZE	METRIC EQ	STRAIGHT THRU	SHUTOFF	A	B
 IN-LINE PIPE THREAD	1/4" NPT		APC10004	APCD10004	0.93 (23.6)	1.4 (25.6)
	1/4" BSPT		APC10004BSPT	APCD10004BSPT	0.93 (23.6)	1.4 (25.6)
	3/8" NPT		APC10006	APCD10006	0.93 (23.6)	1.4 (25.6)
	3/8" BSPT		APC10006BSPT	APCD10006BSPT	0.93 (23.6)	1.4 (25.6)
 IN-LINE HOSE BARB	1/4" ID	6.4mm ID	APC17004		0.93 (23.6)	1.4 (25.6)
	3/8" ID	9.5mm ID	APC17006		0.93 (23.6)	1.4 (25.6)
 IN-LINE WITH SHROUD FERRULELESS POLYTUBE FITTING, PTF†	1/4" OD, 0.17" ID	6.4mm OD, 4.3mm ID	APC13004SH	APCD13004SH	1.3 (33.0)	1.94 (49.3)
		8.0mm OD, 6.0mm ID	APC130M8SH	APCD130M8SH	1.3 (33.0)	2.07 (52.6)
	3/8" OD, 1/4" ID	9.5mm OD, 6.4mm ID	APC13006SH	APCD13006SH	1.3 (33.0)	2.07 (52.6)
		10.0mm OD, 8.0mm ID	APC130M10SH		1.3 (33.0)	2.07 (52.6)
 IN-LINE HOSE BARB	1/4" ID	6.4mm ID	APC17004SH	APCD17004SH	1.3 (33.0)	2.07 (52.6)
	3/8" ID	9.5mm ID	APC17006SH	APCD17006SH	1.3 (33.0)	2.07 (52.6)
 PANEL MOUNT FERRULELESS POLYTUBE FITTING, PTF†	1/4" OD, 0.17" ID	6.4mm OD, 4.3mm ID	APC12004	APCD12004	1.03 (26.2)	1.97 (50.0)
	–	8.0mm OD, 6.0mm ID	APC120M8	APCD120M8	1.03 (26.2)	2.1 (53.3)
	3/8" OD, 1/4" ID	9.5mm OD, 6.4mm ID		APCD12006	1.03 (26.2)	2.1 (53.3)
	–	10.0mm OD, 8.0mm ID		APCD120M10	1.03 (26.2)	2.1 (53.3)
 PANEL MOUNT HOSE BARB	1/4" ID	6.4mm ID	APC16004	APCD16004	1.03 (26.2)	2.1 (53.3)
	5/16" ID	7.9mm ID	APC16005	APCD16005	1.03 (26.2)	2.1 (53.3)
	3/8" ID	9.5mm ID	APC16006	APCD16006	1.03 (26.2)	2.1 (53.3)

All measurements are in inches (millimeters) unless otherwise noted. Tubing must meet stated inside and outside diameters. †NOTE: CPC's Ferruleless Polytube Fitting terminations do not require ferrules to achieve a secure connection, which makes them easier to use and reuse. PTF fittings are designed for semi-rigid tubing, i.e., polyethylene, nylon, polyurethane, etc.

ACCESSORIES

DESCRIPTION	MATERIAL	PART NO.
PANEL MOUNT GASKET REPLACEMENT: For sealing panel mount bodies listed above	Buna-N	1830300

PRODUCT DIMENSIONS

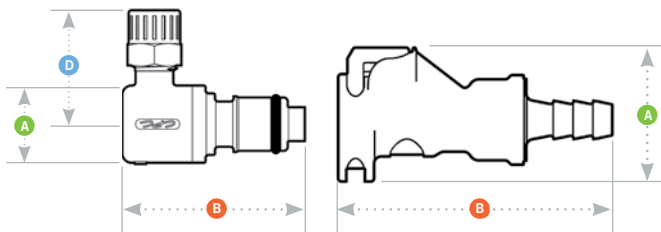



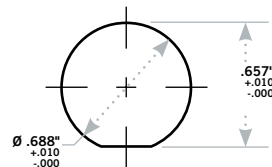

- A** = Height/Diameter
- B** = Total Length
- D** = Elbow Radial Length

PANEL DIMENSIONS

	PANEL OPENING	PANEL THICKNESS MAX.-MIN.	PANEL NUT HEX	PANEL NUT THREAD
COUPLING BODIES	see drawing	.05-.02	13/16	11/16-24UNF



COUPLING INSERTS - Acetal

TERMINATION	TUBING/THREAD SIZE	METRIC EQ	STRAIGHT THRU	SHUTOFF	A	B	D
 IN-LINE PIPE THREAD	1/4" NPT		APC24004	APCD24004	0.72 (18.3)	1.43/1.77 (36.3/45.0)	
	1/4" BSPT		APC24004BSPT	APCD24004BSPT	0.72 (18.3)	1.63/1.77 (41.4/45.0)	
	3/8" NPT		APC24006	APCD24006	0.72 (18.3)	1.50/1.64 (38.1/41.7)	
	3/8" BSPT		APC24006BSPT	APCD24006BSPT	0.72 (18.3)	1.51/1.65 (38.4/41.9)	
 IN-LINE FERRULELESS POLYTUBE FITTING, PTF†	1/4" OD, 0.17" ID	6.4mm OD, 4.3mm ID	APC20004	APCD20004	0.72 (18.3)	1.86/1.99 (47.2/50.6)	
	–	8.0mm OD, 6.0mm ID	APC200M8	APCD200M8	0.72 (18.3)	1.79/1.93 (45.5/49.0)	
	3/8" OD, 1/4" ID	9.5mm OD, 6.4mm ID	APC20006	APCD20006	0.72 (18.3)	1.78/1.91 (45.2/48.5)	
	–	10.0mm OD, 8.0mm ID	APC200M10	APCD200M10	0.72 (18.3)	1.79/1.93 (45.5/49.0)	
 IN-LINE HOSE BARB	1/4" ID	6.4mm ID	APC22004	APCD22004	0.60/0.72 (15.2/18.3)	1.40/2.10 (35.6/53.3)	
	3/8" ID	9.5mm ID	APC22006	APCD22006	0.63/0.72 (16.0/18.3)	1.40/1.92 (35.6/48.8)	
 ELBOW FERRULELESS POLYTUBE FITTING, PTF†	1/4" OD, 0.17" ID	6.4mm OD, 4.3mm ID	APC21004	APCD21004	1.22 (31.0)	1.32/1.45 (33.5/36.8)	0.91 (23.1)
	3/8" OD, 1/4" ID	9.5mm OD, 6.4mm ID	APC21006	APCD21006	1.27 (32.3)	1.33/1.46 (33.8/37.1)	0.96 (24.4)
 ELBOW HOSE BARB	1/4" ID	6.4mm ID	APC23004	APCD23004	0.63 (16.0)	1.20/1.45 (30.5/36.8)	0.96 (24.4)
	3/8" ID	9.5mm ID	APC23006	APCD23006	0.63 (16.0)	1.20/1.5 (30.5/38.1)	0.96 (24.4)

All measurements are in inches (millimeters) unless otherwise noted. Tubing must meet stated inside and outside diameters. Couplings are pictured with valves unless otherwise noted. †NOTE: CPC's Ferruleless PTF (polytube fitting) terminations do not require ferrules to achieve a secure connection and are therefore easier to use and reuse. PTF fittings are designed for semi-rigid tubing, i.e., polyethylene, nylon, polyurethane, etc.

DPC SERIES CONNECTOR

The 1/4" flow DPC Series couplings feature a dual port connection in a contoured design that delivers ease-of-use and excellent flow in a compact size. Made from acetal thermoplastic, the DPC Series includes valved and non-valved couplings with a single plastic thumb latch. One-hand operation makes the DPC Series the choice for simple, simultaneous connections and disconnections where two fluid lines are required.



SPECIFICATIONS

PRESSURE:

Vacuum to 120 psi, 8.3 bar

TEMPERATURE:

32°F to 180°F (0°C to 82°C)

MATERIALS:

Main components: Acetal

Thumb latch: Acetal

Valve spring: 316 stainless steel

External springs: Stainless steel

O-rings: Buna-N

COLOR:

White with blue latch

TUBING SIZES:

1/4" to 3/8" ID, 6.4mm to 9.5mm ID

WARNING: Pressure, temperature, chemicals, and operating environment can affect the performance of couplings. It is the customer's responsibility to test the suitability of CPC's products in their own application conditions.



cpcworldwide.com/DPC

FEATURES

Single thumb latch



Insert keyed to body



Compact, modular design



Integral terminations



BENEFITS

Intuitive one step, two-line connection and disconnection

Ensures correct directional flow

Attractive, high-quality appearance and configuration flexibility

Fewer moving parts, shorter assemblies, faster installations

DPC WATER FLOW

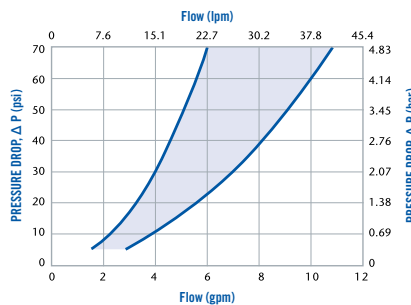

DPC AIR FLOW - 100 psig inlet pressure

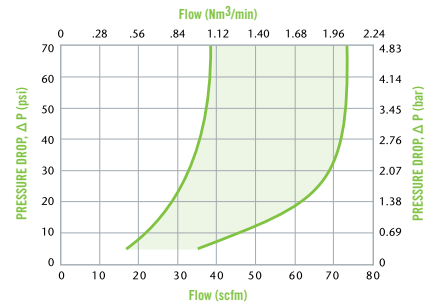

These graphs are intended to give you a general idea of the performance capabilities of each product line. The shaded area of each graph represents the operating range of the product family, i.e., upper and lower values are shown. Therefore, depending on the exact coupling configurations selected, you can reasonably expect values to fall within the shaded area.

DPC SERIES DIMENSIONS

COUPLING BODIES - Acetal



TERMINATION	TUBING/ THREAD SIZE	METRIC EQ.	STRAIGHT THRU	SHUTOFF	A	B	C
IN-LINE HOSE BARB	1/4" ID	6.4mm ID	DPC17004	DPCD17004	1.62 (41.1)	2.09 (52.9)	0.75 (19.1)
	3/8" ID	9.5mm ID	DPC17006	DPCD17006	1.62 (41.1)	2.09 (52.9)	0.75 (19.1)

COUPLING INSERTS - Acetal



TERMINATION	TUBING/ THREAD SIZE	METRIC EQ.	STRAIGHT THRU	SHUTOFF	A	B	C
IN-LINE HOSE BARB	1/4" ID	6.4mm ID	DPC22004	DPCD22004	1.62 (41.1)	1.97/2.11 (50.0/53.6)	0.75 (19.1)
	3/8" ID	9.5mm ID	DPC22006	DPCD22006	1.62 (41.1)	1.97/2.11 (50.0/53.6)	0.75 (19.1)

PRODUCT DIMENSIONS

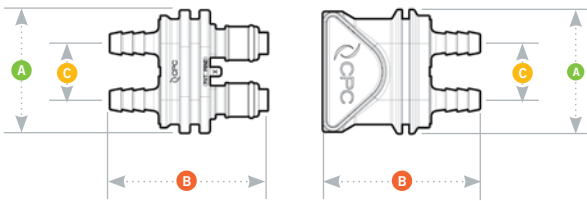

- A = Height/Diameter
- B = Total Length
- C = Center-to-center distance

PANEL DIMENSIONS

	PANEL OPENING	PANEL THICKNESS MAX. – MIN.
COUPLING BODIES	contact CPC	
COUPLING INSERTS	see drawing	0.135 – 0.132

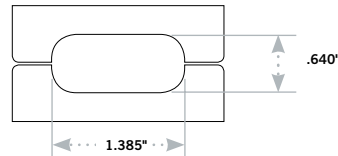

EFC12 SERIES CONNECTOR

The 9/32" flow EFC12 Series couplings feature a high efficiency valve design that provides a greater flow capability than any other coupling its size. Chemically resistant polypropylene material makes it ideal for harsh environments. The EFC12 Series adds a bulkhead panel mount option for tight seals against tank walls and drums.



SPECIFICATIONS

PRESSURE:

Vacuum to 105 psi, 7.2 bar

TEMPERATURE:

32°F to 160°F (0°C to 71°C)

MATERIALS:

Main components and valves: Polypropylene

Thumb latch: Polypropylene

Valve spring: 316 stainless steel

Panel mount gasket: EPDM

External springs: 302 stainless steel

O-rings: EPDM

COLOR:

Gray with dark gray latch

TUBING SIZES:

1/4" and 3/8" ID, 6.4mm and 9.5mm ID

WARNING: Pressure, temperature, chemicals, and operating environment can affect the performance of couplings. It is the customer's responsibility to test the suitability of CPC's products in their own application conditions. Use the graph at the right as a guide.



cpcworldwide.com/EFC12

FEATURES

High efficiency valve



BENEFITS

More flow than PLC Series in a compact size

Plastic thumb latch



Fewer moving parts

Polypropylene material



Chemically resistant and gamma sterilizable

Compatible



Mates with most APC couplings

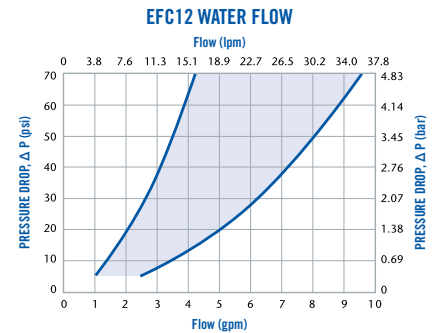
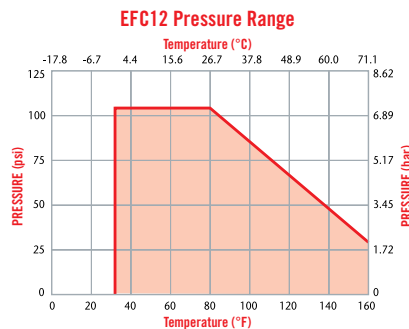
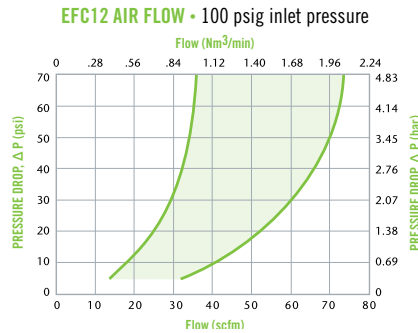

These graphs are intended to give you a general idea of the performance capabilities of each product line. The shaded area of each graph represents the operating range of the product family, i.e., upper and lower values are shown. Therefore, depending on the exact coupling configurations selected, you can reasonably expect values to fall within the shaded area.

EFC12 SERIES DIMENSIONS

COUPLING BODIES - Polypropylene



TERMINATION	TUBING/THREAD SIZE	METRIC EQ	STRAIGHT THRU	SHUTOFF	A	B	D
IN-LINE PIPE THREAD	1/4" NPT			EFC10412	0.93 (23.6)	2.29 (58.2)	
	3/8" NPT			EFC10612	0.93 (23.6)	2.29 (58.2)	
BULKHEAD PANEL MOUNT HOSE BARB	1/4" ID	6.4mm ID		EFC16412	0.93 (23.6)	2.23 (56.6)	
	3/8" ID	9.5mm ID		EFC16612	0.93 (23.6)	2.23 (56.6)	
IN-LINE HOSE BARB	1/4" ID	6.4mm ID		EFC17412	0.93 (23.6)	2.23 (56.6)	
	3/8" ID	9.5mm ID		EFC17612	0.93 (23.6)	2.23 (56.6)	

COUPLING INSERT - Polypropylene



TERMINATION	TUBING/THREAD SIZE	METRIC EQ	STRAIGHT THRU	SHUTOFF	A	B	D
IN-LINE PIPE THREAD	1/4" NPT			EFC24412	0.72 (18.3)	1.77 (45.0)	
	3/8" NPT			EFC24612	0.72 (18.3)	1.77 (45.0)	
IN-LINE HOSE BARB	1/4" ID	6.4mm ID	EFC22412	EFC22412	0.60/0.72 (15.2/18.3)	1.33/2.08 (33.8/52.8)	
	3/8" ID	9.5mm ID	EFC22612	EFC22612	0.60/0.72 (15.2/18.3)	1.33/2.08 (33.8/52.8)	
ELBOW HOSE BARB	1/4" ID	6.4mm ID	EFC23412	EFC23412	0.63 (16.0)	1.32/1.45 (33.5/36.8)	0.96 (24.4)
	3/8" ID	9.5mm ID	EFC23612	EFC23612	0.63 (16.0)	1.32/1.45 (33.5/36.8)	0.96 (24.4)

All measurements are in inches (millimeters) unless otherwise noted. Tubing must meet stated inside and outside diameters. MBLK = molded black material.

ACCESSORIES

DESCRIPTION	MATERIAL	PART NO.
PANEL MOUNT GASKET REPLACEMENT	Buna-N	1830300

PRODUCT DIMENSIONS

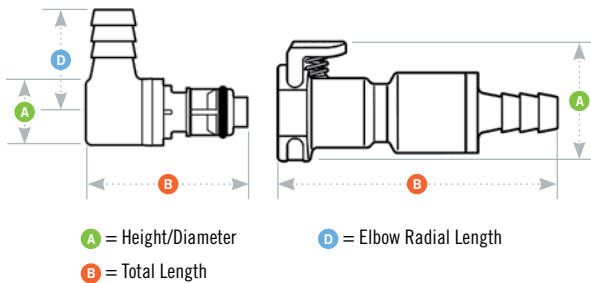

PANEL DIMENSIONS

	PANEL OPENING	PANEL THICKNESS MAX.-MIN.	PANEL NUT HEX	PANEL NUT THREAD
COUPLING BODIES	see drawing	0.25 - 0.03	13/16	11/16-24UNF

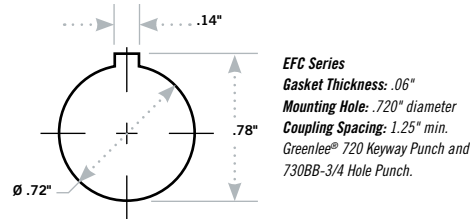

LIQUID FLOW RATE INFORMATION FOR COUPLINGS

The chart below shows the flow rate for CPC couplings. Each coupling was tested with water at 70°F (21°C). To determine flow rates for specific coupling configurations use the formula to the right.

$$Q = C_v \sqrt{\frac{\Delta P}{S}}$$

Q = Flow rate in gallons per minute
C_v = Average coefficient across various flow rates (see chart)
ΔP = Pressure drop across coupling (psi)
S = Specific gravity of liquid

C_v VALUES

	EFC 2000412	EFC10412	EFC10612	EFC16412	EFC16612	EFC17412	EFC17612	EFC2400412	EFC2400612
BODIES	EFC10412	0.51	0.51	0.51	0.51	0.50	0.45	0.50	0.50
	EFC10612	0.61	0.51	1.13	0.72	0.50	0.45	0.81	0.69
	EFC16412	0.51	0.51	0.51	0.51	0.50	0.45	0.50	0.50
	EFC16612	0.61	0.51	1.13	0.72	0.50	0.45	0.81	0.69
	EFC17412	0.51	0.51	0.51	0.51	0.50	0.45	0.50	0.50
	EFC17612	0.61	0.51	1.13	0.72	0.50	0.45	0.81	0.69

INSERTS

NS4 SERIES CONNECTOR

NS4 Series couplings feature non-spill valves in a compact size, at a great price. Use the NS4 when even a few drops pose problems regarding media cost or environmental regulations. These innovative couplings are lightweight, chemically resistant and easy to use. The non-spill design effectively eliminates spills and minimizes downtime. NS4 couplings are also available with optional RFID (Radio Frequency Identification) capability.



SPECIFICATIONS

PRESSURE:

Vacuum to 120 psi, 8.3 bar

TEMPERATURE:

32°F to 160°F (0°C to 71°C)

MATERIALS:

Main components and valves:

Glass-filled polypropylene with TPV* overmold, ABS with TPE* soft-touch overmold

Thumb latch: Glass-filled polypropylene, ABS

Valve spring: 316 stainless steel

External spring: 316 stainless steel

O-rings: EPDM

COLOR:

Polypropylene: Gray with dark gray overmold standard; gray with red or blue overmold available†

ABS: White with teal overmold

TUBING SIZES:

1/8" to 3/8" ID, 3.2mm to 9.5mm ID

LUBRICANTS: Krytox® PFPE (inert)

SPILLAGE:

<0.10 cc per disconnect at all rated pressures

INCLUSION: 0.26 cc per connect

WARNING: Pressure, temperature, chemicals, and operating environment can affect the performance of couplings. It is the customer's responsibility to test the suitability of CPC's products in their own application conditions.

*The overmold material TPV (thermoplastic vulcanizate) is used with the NS4 polypropylene couplings. TPV is an alloy of polypropylene thermoplastic and fully vulcanized EPDM rubber. TPV is typically resistant to water, acids and bases. The overmold material TPE (thermoplastic elastomer) is used with the NS4 ABS couplings. TPE is a blend of additives and copolymers in a special formulation that forms extremely durable bonds to the ABS substrate, while offering the traditional properties of soft-touch overmold.

†NOTE: Standard product is gray; color options require a minimum quantity. Please contact CPC for details.

FEATURES

- Non-spill design → Disconnect under pressure with no spills
- Color coding → Instant visual differentiation of media lines
- Glass-filled polypropylene → Durable and compatible with many chemicals
- Medical-grade ABS → Gamma sterilizable

BENEFITS

NS4 WATER FLOW

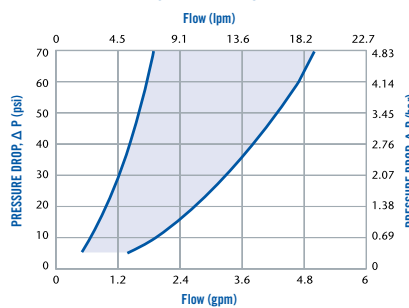

NS4 Pressure Range

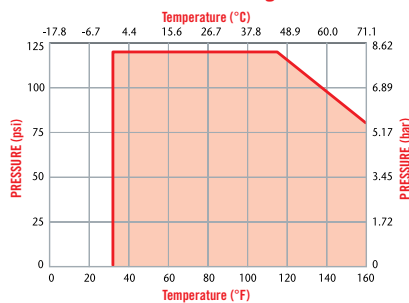

These graphs are intended to give you a general idea of the performance capabilities of each product line. The shaded area of each graph represents the operating range of the product family, i.e., upper and lower values are shown. Therefore, depending on the exact coupling configurations selected, you can reasonably expect values to fall within the shaded area.



cpcworldwide.com/NS4

NS4 SERIES DIMENSIONS

COUPLING BODIES - Polypropylene/ABS

TERMINATION	TUBING/THREAD SIZE	METRIC EQ.	ABS SHUTOFF	POLYPROPYLENE SHUTOFF	A	B
IN-LINE PIPE THREAD	1/4" NPT		NS4D1000406	NS4D10004	1.05 (26.7)	2.31 (58.7)
	1/4" BSPT			NS4D10004BSPT	1.05 (26.7)	2.29 (58.2)
IN-LINE FERRULESS POLYTUBE FITTING, PTF†	1/4" OD, .17" ID	6.4mm OD, 4.3mm ID	NS4D1300606	NS4D13004	1.05 (26.7)	2.32 (58.9)
	3/8" OD, 1/4" ID	9.5mm OD, 6.4mm ID		NS4D13006	1.05 (26.7)	2.45 (62.2)
IN-LINE HOSE BARB	1/8" ID*	3.2mm ID*	NS4D1700206	NS4D17002	1.05 (26.7)	2.09 (53.1)
	1/4" ID	6.4mm ID	NS4D1700406	NS4D17004	1.05 (26.7)	2.34 (59.4)
	3/8" ID	9.5mm ID	NS4D1700606	NS4D17006	1.05 (26.7)	2.34 (59.4)
IN-LINE HOSE BARB (RS-232 INTERFACE)	1/8" ID	3.2mm ID		iNS4DR1700200	2.15 (54.6)	3.49 (88.6)
	1/4" ID	6.4mm ID		iNS4DR1700400	2.15 (54.6)	3.49 (88.6)
	3/8" ID	9.5mm ID		iNS4DR1700600	2.15 (54.6)	3.49 (88.6)
IN-LINE HOSE BARB (USB INTERFACE)	1/4" ID	6.4mm ID		iNS4DR1700201	2.15 (54.6)	3.4 (86.4)
	3/8" ID	9.5mm ID		iNS4DR1700401	2.15 (54.6)	3.4 (86.4)
	1/2" ID	12.7mm ID		iNS4DR1700601	2.15 (54.6)	3.4 (86.4)

COUPLING INSERTS - Polypropylene/ABS

TERMINATION	TUBING/THREAD SIZE	METRIC EQ.	ABS SHUTOFF	POLYPROPYLENE SHUTOFF	A	B
IN-LINE PIPE THREAD	1/4" NPT		NS4D2400406	NS4D24004	0.96 (24.4)	1.95 (49.5)
	1/4" BSPT		NS4D24004BSPT06	NS4D24004BSPT	0.96 (24.4)	1.95 (49.5)
IN-LINE FERRULESS POLYTUBE FITTING, PTF†	1/4" OD, .17" ID	6.4mm OD, 4.3mm ID		NS4D20004	0.96 (24.4)	1.95 (49.5)
	3/8" OD, 1/4" ID	9.5mm OD, 6.4mm ID		NS4D20006	0.96 (24.4)	2.09 (53.1)
IN-LINE HOSE BARB	1/8" ID*	3.2mm ID*		NS4D22002	0.96 (24.4)	1.73 (43.9)
	1/4" ID	6.4mm ID	NS4D2200406	NS4D22004	0.96 (24.4)	1.98 (50.3)
	3/8" ID	9.5mm ID	NS4D2200606	NS4D22006	0.96 (24.4)	1.98 (50.3)
PANEL MOUNT FERRULESS POLYTUBE FITTING, PTF†	1/4" OD, .17" ID	6.4mm OD, 4.3mm ID		NS4D40004	1.17 (29.7)	2.3 (58.4)
	3/8" OD, 1/4" ID	9.5mm OD, 6.4mm ID		NS4D40006	1.17 (29.7)	2.3 (58.4)
PANEL MOUNT HOSE BARB	1/8" ID*	3.2mm ID*	NS4D4200406	NS4D42002	1.17 (29.7)	2.07 (52.6)
	1/4" ID	6.4mm ID		NS4D42004	1.17 (29.7)	2.32 (58.9)
	3/8" ID	9.5mm ID		NS4D42006	1.17 (29.7)	2.32 (58.9)
PANEL MOUNT HOSE BARB ELBOW	1/4" ID	6.4mm ID		NS4D43004	1.19 (30.2)	2.39 (60.7)
	3/8" ID	9.5mm ID		NS4D43006	1.19 (30.2)	2.39 (60.7)
ELBOW HOSE BARB	1/4" ID	6.4mm ID		NS4D23004	0.96 (24.4)	2.04 (51.8)
	3/8" ID	9.5mm ID		NS4D23006	0.96 (24.4)	2.04 (51.8)
IN-LINE HOSE BARB (RS-232 INTERFACE)	1/4" ID	6.4mm ID		iNS4DT2200400		
	3/8" ID	9.5mm ID		iNS4DT2200600		

All measurements are in inches (millimeters) unless otherwise noted. Tubing must meet stated inside and outside diameters. PTF fittings are designed for semi-rigid tubing, i.e., polyethylene, nylon, polyurethane, etc. †NOTE: CPC's Ferruleless PTF (polytube fitting) terminations do not require ferrules to achieve a secure connection and are therefore easier to use and reuse. *NOTE: 1/8" ID (3.2mm) hose barb connection has a support shroud allowing a maximum tube OD of 1/4" (6.4mm).

ACCESSORIES

DESCRIPTION	MATERIAL	PART NO.
PANEL MOUNT GASKET REPLACEMENT: FOR SEALING PANEL MOUNT INSERTS LISTED ABOVE	EPDM	1879800
	FKM	1889500

PRODUCT DIMENSIONS

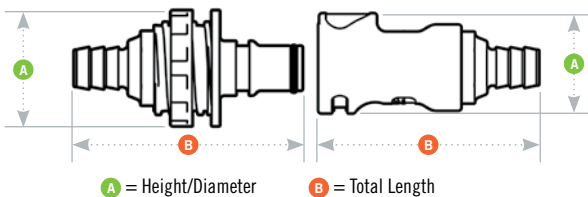

PANEL DIMENSIONS

	PANEL OPENING	PANEL THICKNESS MAX.-MIN.
COUPLING INSERTS	see drawing	0.25 - 0.03

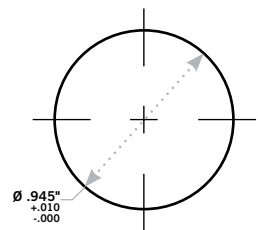

EVERIS™ LQ2 SERIES CONNECTOR

Everis™ LQ2 Series quick disconnect couplings with 1/8" flow are designed for liquid cooling applications. With a small form factor for tight spaces, Everis LQ2 connectors offer a high-flow capacity to optimize system performance. The couplings' patented design offers reliable long-term connections and provides drip-free connections and disconnections to protect sensitive equipment. EPDM, FVMQ and FKM seals are standard options for compatibility with water, glycol and dielectric coolants. For other material and termination options, see your regional CPC sales representative.



SPECIFICATIONS

PRESSURE: Vacuum to 200 psi, 13.8 bar

TEMPERATURE:

Operating: 0°F to 240°F (-17°C to 115°C)

Storage/Shipping:

-40°F to 240°F (-40°C to 115°C)

MAXIMUM FLOW AT DISCONNECT:

1.00 gal/min at 0 – 100 psi

0.25 gal/min at 101 – 200 psi

MATERIALS:

Main Components: Nickel-chrome plated brass

Valves and Thumb latch: Polysulfone

Valve Springs (wetted): Stainless steel

External spring: Stainless steel

Seals: EPDM standard (FKM, FVMQ options)

Compliance: RoHS, REACH

COLOR: Chrome with Cool Blue or Warm Red

TUBING SIZES: 1/4" ID (6.4mm ID)

LUBRICANTS: Krytox® PFPE

SPILLAGE:

<0.015 cc per disconnect at 0 psi

<0.063 cc per disconnect rated at 200 psi

AIR INCLUSION: <0.04 cc per connect

FLOW COEFFICIENT: Cv ~0.4 (0.3 Kv)

WARNING: Pressure, temperature, chemicals, and operating environment can affect the performance of couplings. It is the customer's responsibility to test the suitability of CPC's products in their own application conditions.

FEATURES

Non-spill valve

Redundant multi-lobed seals

High flow capacity with low pressure drop

EPDM, FKM or FVMQ seals

Ergonomic body and latch design

Audible click

Color coding

Low profile

Swivel connection

Single-piece options for insert

BENEFITS

Disconnect under pressure with no spills

Extra protection from leak-causing contaminants and debris

Efficient, cost-effective cooling

Compatibility with common coolants (e.g. glycol/water, mineral oil) and application temperatures

Simple, intuitive one-handed operation

Connection assurance

Instant visual identification of cooling lines

Meets size requirements for space-constrained electronics

Allows user to orient latch or tube to facilitate installation and maintenance

Space saving

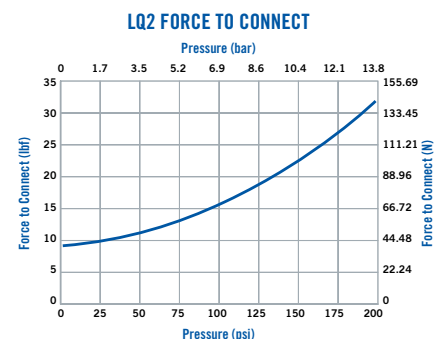
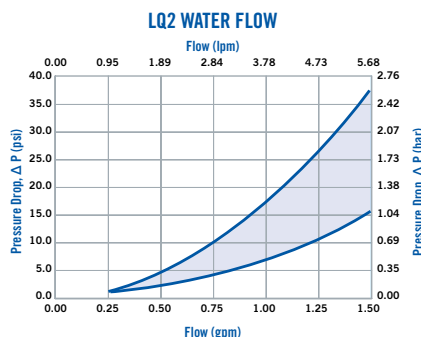

These graphs are intended to give you a general idea of the performance capabilities of each product line. Contact CPC for flow of a particular coupling combination.

EVERIS™ LQ2 SERIES DIMENSIONS

COUPLING BODIES - Nickel-chrome plated brass

TERMINATION	TUBING/THREAD SIZE	METRIC EQ.	SHUTOFF	HEX	A	B	C	D
IN-LINE LOCKING HOSE BARB	1/4" ID	6.4mm ID	LQ2D1704LRED		0.82 (20.9)	2.09 (53.1)	1.34 (34.0)	
			LQ2D1704LBLU		0.82 (20.9)	2.09 (53.1)	1.34 (34.0)	
IN-LINE STRAIGHT THREAD PORT SAE	1/4 SAE-4: 7/16-20 ¹		LQ2D3004RED	9/16"	0.82 (20.9)	1.72 (43.6)	1.34 (34.0)	
			LQ2D3004BLU	9/16"	0.82 (20.9)	1.72 (43.6)	1.34 (34.0)	
ELBOW LOCKING HOSE BARB	1/4" ID	6.4mm ID	LQ2D3304LRED		0.79 (20.1)	1.64 (41.5)	1.64 (41.5)	1.03 (26.2)
			LQ2D3304LBLU		0.79 (20.1)	1.64 (41.5)	1.64 (41.5)	1.03 (26.2)
IN-LINE THREAD G / BSPP	G1/8 ²		LQ2D3102RED	15mm	0.82 (20.9)	1.67 (42.5)	1.39 (35.3)	
			LQ2D3102BLU	15mm	0.82 (20.9)	1.67 (42.5)	1.39 (35.3)	

COUPLING INSERTS - Nickel-chrome plated brass

TERMINATION	TUBING/THREAD SIZE	METRIC EQ.	SHUTOFF	HEX	A	B	C	D
IN-LINE LOCKING HOSE BARB	1/4" ID	6.4mm ID	LQ2D2204LRED		0.56 (14.3)	1.96 (49.8)	0.44 (11.2)	
			LQ2D2204LBLU		0.56 (14.3)	1.96 (49.8)	0.44 (11.2)	
IN-LINE STRAIGHT THREAD SAE	1/4 SAE-4: 7/16-20 ^{1,3}		LQ2D4604RED	9/16"	0.56 (14.3)	1.28 (32.4)	0.15 (3.8)	
			LQ2D4604BLU	9/16"	0.56 (14.3)	1.28 (32.4)	0.15 (3.8)	
ELBOW LOCKING HOSE BARB	1/4" ID	6.4mm ID	LQ2D2304LRED		0.56 (14.3)	1.51 (38.2)	0.74 (18.7)	1.03 (26.2)
			LQ2D2304LBLU		0.56 (14.3)	1.51 (38.2)	0.74 (18.7)	1.03 (26.2)
IN-LINE STRAIGHT THREAD G / BSPP	G1/8 ^{2,3}		LQ2D4702RED	15mm	0.59 (15.0)	1.20 (30.5)	0.15 (3.8)	
			LQ2D4702BLU	15mm	0.59 (15.0)	1.20 (30.5)	0.15 (3.8)	

All measurements are in inches (millimeters) unless otherwise noted.
 For FKM seal option, add V suffix to part number. Example: LQ2D3004REDV
 For FVMQ seal option, add FLS suffix to part number. Example: LQ2D3004REDFLS
¹All SAE terminations are compatible with SAE J1926-1 ports.

PRODUCT DIMENSIONS

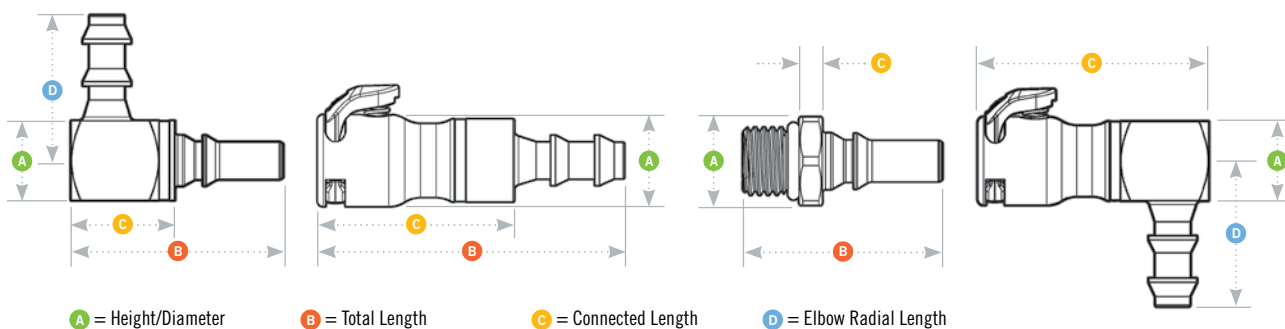

DID YOU KNOW

“Spillage” can be easily misconstrued. Depending upon flow size, a typical QD will emit less than 0.02 cc of fluid, which often equates to a wetted surface on the face of the connector.

cpcworldwide.com/Everis-LQ2

EVERIS™ LQ4 SERIES CONNECTOR

Everis™ LQ4 Series quick disconnect couplings

with 1/4" flow offer a relative high-flow capacity to optimize system performance. The couplings' patented design offers reliable long-term connections and provides drip-free connections and disconnections to protect sensitive equipment. EPDM, FVMQ and FKM seals are standard options for compatibility with water, glycol or dielectric coolants. For other material and termination options see your regional CPC sales representative.



SPECIFICATIONS

PRESSURE: Vacuum to 120 psi, 8.3 bar

TEMPERATURE:

Operating: 0°F to 240°F (-17°C to 115°C)

Storage/Shipping:

-40°F to 240°F (-40°C to 115°C)

MAXIMUM FLOW AT DISCONNECT:

3.0 gal/min, 11.3L/min

MATERIALS:

Main Components:

Nickel-chrome plated brass

Valves and Thumb latch: Polysulfone

Valve Springs (wetted): Stainless steel

External spring: Stainless steel

Seals: EPDM standard (FKM, FVMQ options)

Compliance: RoHS, REACH

COLOR: Chrome with Cool Blue or Warm Red

TUBING SIZES:

1/4" to 3/8" ID, 6.4mm to 9.5mm ID

LUBRICANTS: Krytox® PFPE

SPILLAGE:

0.025 cc per disconnect rated at 0 psi

0.055 cc per disconnect rated at 120 psi

AIR INCLUSION: 0.020 cc per connect

FLOW COEFFICIENT: Cv ~1.4 (1.2 Kv)

WARNING: Pressure, temperature, chemicals, and operating environment can affect the performance of couplings. It is the customer's responsibility to test the suitability of CPC's products in their own application conditions.

FEATURES

- Non-spill valve → Disconnect under pressure with no spills
- Redundant multi-lobed seals → Extra protection from leak-causing contaminants and debris
- High flow capacity with low pressure drop → Efficient, cost-effective cooling system
- EPDM, FKM or FVMQ seals → Compatibility with common coolants (e.g. glycol/water, mineral oil) and application temperatures
- Ergonomic body and latch design → Simple, intuitive one-handed operation
- Audible click → Connection assurance
- Color coding → Instant visual identification of cooling lines
- Low profile → Meets size requirements for space-constrained electronics
- Swivel connection → Allows user to orient latch or tube to facilitate installation and maintenance
- Single-piece options for insert → Space saving

BENEFITS

LQ4 WATER FLOW (0-10 GPM)

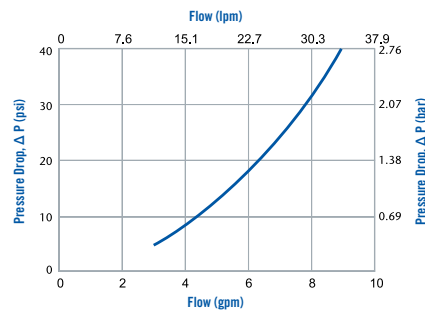

LQ4 FORCE TO CONNECT

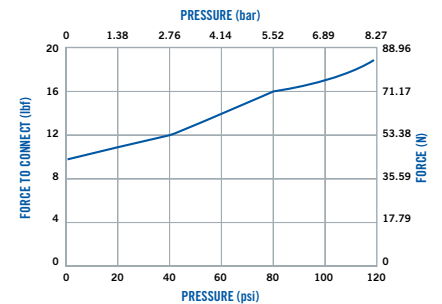

These graphs are intended to give you a general idea of the performance capabilities of each product line. Contact CPC for flow of a particular coupling combination.



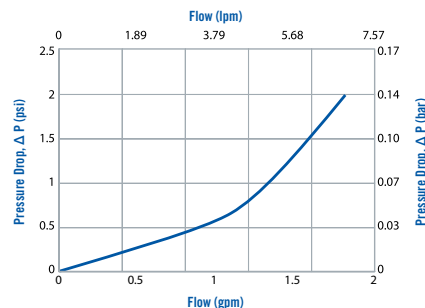



LQ4 WATER FLOW (0-2 GPM)









cpcworldwide.com/Everis-LQ4

EVERIS™ LQ4 SERIES DIMENSIONS

COUPLING BODIES - Nickel-chrome plated brass

TERMINATION	TUBING/THREAD SIZE	METRIC EQ.	SHUTOFF	HEX	A	B	C
	IN-LINE LOCKING HOSE BARB	1/4" ID	6.4mm ID	LQ4D17004LRED	0.98 (24.8)	2.60 (65.9)	1.85 (46.9)
	1/4" ID	6.4mm ID	LQ4D17004LBLU	0.98 (24.8)	2.60 (65.9)	1.85 (46.9)	
	3/8" ID	9.5mm ID	LQ4D17006LRED	0.98 (24.8)	2.69 (68.2)	1.81 (46.0)	
	3/8" ID	9.5mm ID	LQ4D17006LBLU	0.98 (24.8)	2.69 (68.2)	1.81 (46.0)	
	IN-LINE HOSE BARB	1/4" ID	6.4mm ID	LQ4D17004RED	0.98 (24.8)	2.50 (63.4)	1.85 (46.9)
	1/4" ID	6.4mm ID	LQ4D17004BLU	0.98 (24.8)	2.50 (63.4)	1.85 (46.9)	
	3/8" ID	9.5mm ID	LQ4D17006RED	0.98 (24.8)	2.50 (63.4)	1.85 (46.9)	
	3/8" ID	9.5mm ID	LQ4D17006BLU	0.98 (24.8)	2.50 (63.4)	1.85 (46.9)	
	IN-LINE STRAIGHT THREAD SAE	1/4 SAE-4: 7/16-20 ¹		LQ4D30004RED	13/16"	0.98 (24.8)	2.21 (56.0)
	1/4 SAE-4: 7/16-20 ¹		LQ4D30004BLU	13/16"	0.98 (24.8)	2.21 (56.0)	
	3/8 SAE-6: 9/16-18 ¹		LQ4D30006RED	13/16"	0.98 (24.8)	2.24 (56.8)	
	3/8 SAE-6: 9/16-18 ¹		LQ4D30006BLU	13/16"	0.98 (24.8)	2.24 (56.8)	
	IN-LINE PIPE THREAD	1/4" NPT		LQ4D10004RED	13/16"	0.98 (24.8)	2.35 (59.6)
	1/4" NPT		LQ4D10004BLU	13/16"	0.98 (24.8)	2.35 (59.6)	
	3/8" NPT		LQ4D10006RED	13/16"	0.98 (24.8)	2.35 (59.6)	
	3/8" NPT		LQ4D10006BLU	13/16"	0.98 (24.8)	2.35 (59.6)	
	IN-LINE PTF	1/4" ID x 3/8" OD		LQ4D13006RED	13/16"	0.98 (24.8)	2.50 (63.4)
	1/4" ID x 3/8" OD		LQ4D13006BLU	13/16"	0.98 (24.8)	2.50 (63.4)	
	IN-LINE THREAD G / BSPP	G1/4 ²		LQ4D31004RED	20mm	0.98 (24.8)	2.29 (58.0)
	G1/4 ²		LQ4D31004BLU	20mm	0.98 (24.8)	2.29 (58.0)	
	G3/8 ²		LQ4D31006RED	22mm	0.98 (24.8)	2.29 (58.0)	
	G3/8 ²		LQ4D31006BLU	22mm	0.98 (24.8)	2.29 (58.0)	

COUPLING INSERTS - Nickel-chrome plated brass

TERMINATION	TUBING/THREAD SIZE	METRIC EQ.	SHUTOFF	HEX	A	B	C
	IN-LINE LOCKING HOSE BARB	1/4" ID	6.4mm ID	LQ4D22004LRED	0.80 (20.3)	2.44 (62.1)	0.63 (16.0)
	1/4" ID	6.4mm ID	LQ4D22004LBLU	0.80 (20.3)	2.44 (62.1)	0.63 (16.0)	
	3/8" ID	9.5mm ID	LQ4D22006LRED	0.80 (20.3)	2.53 (64.4)	0.59 (15.1)	
	3/8" ID	9.5mm ID	LQ4D22006LBLU	0.80 (20.3)	2.53 (64.4)	0.59 (15.1)	
	IN-LINE HOSE BARB	1/4" ID	6.4mm ID	LQ4D22004RED	0.80 (20.3)	2.34 (59.5)	0.63 (16.0)
	1/4" ID	6.4mm ID	LQ4D22004BLU	0.80 (20.3)	2.34 (59.5)	0.63 (16.0)	
	3/8" ID	9.5mm ID	LQ4D22006RED	0.80 (20.3)	2.34 (59.5)	0.63 (16.0)	
	3/8" ID	9.5mm ID	LQ4D22006BLU	0.80 (20.3)	2.34 (59.5)	0.63 (16.0)	
	IN-LINE STRAIGHT THREAD SAE	1/4 SAE-4: 7/16-20 ¹		LQ4D46004RED	13/16"	0.88 (22.4)	2.05 (52.2)
	1/4 SAE-4: 7/16-20 ¹		LQ4D46004BLU	13/16"	0.88 (22.4)	2.05 (52.2)	
	3/8 SAE-6: 9/16-18 ^{1,3}		LQ4D46006RED	11/16"	0.75 (19.1)	1.65 (41.8)	
	3/8 SAE-6: 9/16-18 ^{1,3}		LQ4D46006BLU	11/16"	0.75 (19.1)	1.65 (41.8)	
	IN-LINE PIPE THREAD	1/4" NPT		LQ4D24004RED	13/16"	0.88 (22.4)	2.19 (55.7)
	1/4" NPT		LQ4D24004BLU	13/16"	0.88 (22.4)	2.19 (55.7)	
	3/8" NPT		LQ4D24006RED	13/16"	0.88 (22.4)	2.19 (55.7)	
	3/8" NPT		LQ4D24006BLU	13/16"	0.88 (22.4)	2.19 (55.7)	
	IN-LINE PTF	1/4" ID x 3/8" OD		LQ4D20006RED	13/16"	0.88 (22.4)	2.34 (59.5)
	1/4" ID x 3/8" OD		LQ4D20006BLU	13/16"	0.88 (22.4)	2.34 (59.5)	
	IN-LINE STRAIGHT THREAD G / BSPP	G1/4 ²		LQ4D47004RED	20mm	0.85 (21.6)	2.13 (54.2)
	G1/4 ²		LQ4D47004BLU	20mm	0.85 (21.6)	2.13 (54.2)	
	G3/8 ^{2,3}		LQ4D47006RED	22mm	0.93 (23.6)	1.66 (42.0)	
	G3/8 ^{2,3}		LQ4D47006BLU	22mm	0.93 (23.6)	1.66 (42.0)	

For FKM seal option, add V suffix to part number. Example: LQ4D30006BLUV
 For FVMQ seal option, add FLS suffix to part number. Example: LQ4D30006BLUFLS

¹All SAE terminations are compatible with SAE J1926-1 ports.
²All G (BSPP) terminations are compatible with ISO 1179-1 ports.
³One-piece design

PRODUCT DIMENSIONS

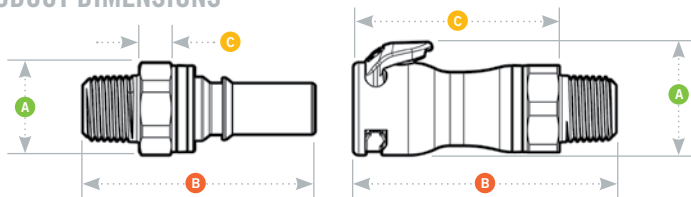

- A = Height/Diameter
- B = Total Length
- C = Connected Length

All measurements are in inches (millimeters) unless otherwise noted.

EVERIS™ LQ6 SERIES CONNECTOR

Everis™ LQ6 Series quick disconnect couplings feature 3/8" flow for liquid cooling of electronics applications. Everis LQ6 connectors offer a high-flow capacity to optimize liquid cooling system performance. The couplings' patented design offers reliable long-term connections and the non-spill valves provide drip-free connections and disconnections to protect sensitive equipment. FKM, FVMQ and EPDM seals are standard options for compatibility with dielectric or glycol/water coolants. For other material and termination options see your regional CPC sales representative.



SPECIFICATIONS

PRESSURE: Vacuum to 120 psi, 8.3 bar

TEMPERATURE:

Operating: 0°F to 240°F (-17°C to 115°C)

Storage/Shipping:

-40°F to 240°F (-40°C to 115°C)

MAXIMUM FLOW AT DISCONNECT:

5.0 gal/min, 11.3L/min

MATERIALS:

Main Components:

Nickel-chrome plated brass

Valves and Thumb latch: Polysulfone

Valve Springs (wetted): Stainless steel

External spring: Stainless steel

Seals: EPDM standard (FKM, FVMQ options)

Compliance: RoHS, REACH

COLOR: Chrome with Cool Blue or Warm Red

TUBING SIZES:

3/8" to 1/2" ID, 9.5mm to 12.7mm ID

LUBRICANTS: Krytox® PFPE

SPILLAGE:

0.03 cc per disconnect rated at 0 psi

0.03 cc per disconnect rated at 120 psi

AIR INCLUSION:

0.33 cc per connect

FLOW COEFFICIENT: Cv ~2.2 (1.9 Kv)

WARNING: Pressure, temperature, chemicals, and operating environment can affect the performance of couplings. It is the customer's responsibility to test the suitability of CPC's products in their own application conditions.

FEATURES

- Non-spill valve → Disconnect under pressure with no spills
- Redundant multi-lobed seals → Extra protection from leak-causing contaminants and debris
- High flow capacity with low pressure drop → Efficient, cost-effective cooling system
- EPDM, FKM or FVMQ seals → Compatibility with common coolants (e.g. glycol/water, mineral oil) and application temperatures
- Ergonomic body and latch design → Simple, intuitive one-handed operation
- Audible click → Connection assurance
- Color coding → Instant visual identification of cooling lines
- Low profile → Meets size requirements for space-constrained electronics
- Swivel connection → Allows user to orient latch or tube to facilitate installation and maintenance
- Single-piece options for insert → Space saving

BENEFITS

LQ6 WATER FLOW (0-20 GPM)

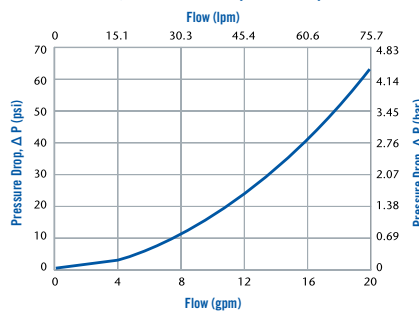

LQ6 FORCE TO CONNECT

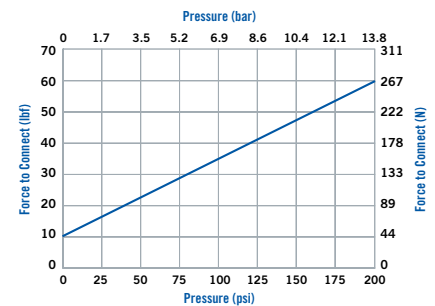

These graphs are intended to give you a general idea of the performance capabilities of each product line. Contact CPC for flow of a particular coupling combination.



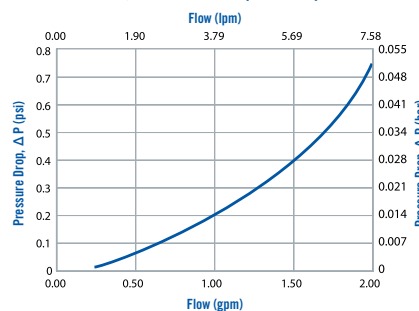



LQ6 WATER FLOW (0-2 GPM)









cpcworldwide.com/Everis-LQ6

EVERIS™ LQ6 SERIES DIMENSIONS

COUPLING BODIES - Nickel-chrome plated brass

TERMINATION	TUBING/THREAD SIZE	METRIC EQ.	SHUTOFF	HEX	A	B	C
	IN-LINE LOCKING HOSE BARB	3/8" ID	9.5mm ID	LQ6D17006LRED	1.19 (30.1)	2.96 (75.1)	2.08 (52.8)
		3/8" ID	9.5mm ID	LQ6D17006LBLU	1.19 (30.1)	2.96 (75.1)	2.08 (52.8)
		1/2" ID	12.7mm ID	LQ6D17008LRED	1.19 (30.1)	3.08 (78.2)	2.08 (52.8)
		1/2" ID	12.7mm ID	LQ6D17008LBLU	1.19 (30.1)	3.08 (78.2)	2.08 (52.8)
	IN-LINE HOSE BARB	3/8" ID	9.5mm ID	LQ6D17006RED	1.19 (30.1)	2.73 (69.3)	2.08 (52.8)
		3/8" ID	9.5mm ID	LQ6D17006BLU	1.19 (30.1)	2.73 (69.3)	2.08 (52.8)
		1/2" ID	12.7mm ID	LQ6D17008RED	1.19 (30.1)	2.73 (69.3)	2.08 (52.8)
		1/2" ID	12.7mm ID	LQ6D17008BLU	1.19 (30.1)	2.73 (69.3)	2.08 (52.8)
	IN-LINE STRAIGHT THREAD PORT SAE	3/8 SAE-6: 9/16-18 ¹		LQ6D30006RED	1"	1.19 (30.1)	2.47 (62.7)
		3/8 SAE-6: 9/16-18 ¹		LQ6D30006BLU	1"	1.19 (30.1)	2.47 (62.7)
		1/2 SAE-8: 3/4-16 ¹		LQ6D30008RED	1"	1.19 (30.1)	2.52 (64.0)
		1/2 SAE-8: 3/4-16 ¹		LQ6D30008BLU	1"	1.19 (30.1)	2.52 (64.0)
	IN-LINE PIPE THREAD	3/8" NPT		LQ6D10006RED	1"	1.19 (30.1)	2.58 (65.5)
		3/8" NPT		LQ6D10006BLU	1"	1.19 (30.1)	2.58 (65.5)
	IN-LINE PTF	3/8" ID x 1/2" OD		LQ6D13008RED	1"	1.19 (30.1)	2.91 (73.9)
		3/8" ID x 1/2" OD		LQ6D13008BLU	1"	1.19 (30.1)	2.91 (73.9)
	IN-LINE THREAD G / BSPP	G3/8 ²		LQ6D31006RED	26mm	1.19 (30.1)	2.59 (67.3)
		G3/8 ²		LQ6D31006BLU	26mm	1.19 (30.1)	2.59 (67.3)
		G1/2 ²		LQ6D31008RED	26mm	1.19 (30.1)	2.59 (67.3)
		G1/2 ²		LQ6D31008BLU	26mm	1.19 (30.1)	2.59 (67.3)

COUPLING INSERTS - Nickel-chrome plated brass

TERMINATION	TUBING/THREAD SIZE	METRIC EQ.	SHUTOFF	HEX	A	B	C
	IN-LINE LOCKING HOSE BARB	3/8" ID	9.5mm ID	LQ6D22006LRED	1.0 (25.3)	2.79 (70.7)	0.65 (16.4)
		3/8" ID	9.5mm ID	LQ6D22006LBLU	1.0 (25.3)	2.79	0.65 (16.4)
		1/2" ID	12.7mm ID	LQ6D22008LRED	1.0 (25.3)	2.91	0.65 (16.4)
		1/2" ID	12.7mm ID	LQ6D22008LBLU	1.0 (25.3)	2.91	0.65 (16.4)
	IN-LINE HOSE BARB	3/8" ID	9.5mm ID	LQ6D22006RED	1.0 (25.3)	2.56 (65.0)	0.65 (16.4)
		3/8" ID	9.5mm ID	LQ6D22006BLU	1.0 (25.3)	2.56 (65.0)	0.65 (16.4)
		1/2" ID	12.7mm ID	LQ6D22008RED	1.0 (25.3)	2.56 (65.0)	0.65 (16.4)
		1/2" ID	12.7mm ID	LQ6D22008BLU	1.0 (25.3)	2.56 (65.0)	0.65 (16.4)
	IN-LINE STRAIGHT THREAD PORT SAE	3/8 SAE-6: 9/16-18 ¹		LQ6D46006RED	1"	1.10 (27.9)	2.30 (58.4)
		3/8 SAE-6: 9/16-18 ¹		LQ6D46006BLU	1"	1.10 (27.9)	2.30 (58.4)
		1/2 SAE-8: 3/4-16 ^{1,3}		LQ6D46008RED	7/8"	1.10 (27.9)	1.95 (49.6)
		1/2 SAE-8: 3/4-16 ^{1,3}		LQ6D46008BLU	7/8"	1.10 (27.9)	1.95 (49.6)
	IN-LINE PIPE THREAD	3/8" NPT		LQ6D24006RED	1"	1.10 (27.9)	2.41 (61.2)
		3/8" NPT		LQ6D24006BLU	1"	1.10 (27.9)	2.41 (61.2)
	IN-LINE PTF	3/8" ID x 1/2" OD		LQ6D20008RED	1"	1.10 (27.9)	2.74 (69.6)
		3/8" ID x 1/2" OD		LQ6D20008BLU	1"	1.10 (27.9)	2.74 (69.6)
	IN-LINE THREAD G / BSPP	G3/8 ²		LQ6D47006RED	26mm	1.12 (28.4)	2.42 (61.5)
		G3/8 ²		LQ6D47006BLU	26mm	1.12 (28.4)	2.42 (61.5)
		G1/2 ^{2,3}		LQ6D47008RED	26mm	1.12 (28.4)	2.04 (51.8)
		G1/2 ^{2,3}		LQ6D47008BLU	26mm	1.12 (28.4)	2.04 (51.8)

For FKM seal option, add V suffix to part number. Example: LQ6D17006BLUV
 For FVMQ seal option, add FLS suffix to part number. Example: LQ6D17006BLUFLS

¹All SAE terminations are compatible with SAE J1926-1 ports.
²All G (BSPP) terminations are compatible with ISO 1179-1 ports.
³One-piece design

PRODUCT DIMENSIONS

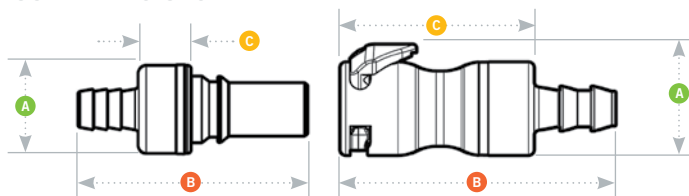

- A = Height/Diameter
- B = Total Length
- C = Connected Length

All measurements are in inches (millimeters) unless otherwise noted.

EVERIS™ LQ8 SERIES CONNECTOR

Everis™ LQ8 Series quick disconnect couplings feature 1/2" flow for liquid cooling of electronics applications. Specifically designed for thermal management applications, Everis LQ8 connectors offer a high-flow capacity to optimize liquid cooling system performance. They provide ultra-reliable, dripless connections and disconnections for ease of use and peace of mind given proximity to sensitive or valuable equipment components. LQ8 quick disconnects (QDs) use a patented design which offers reliable long-term connections. EPDM seals are a standard for compatibility with glycol/water coolants. For other material and termination options contact CPC; CPC sales representatives and applications engineers are available to assist with any questions you may have.



SPECIFICATIONS

PRESSURE: Vacuum to 120 psi, 8.3 bar

TEMPERATURE:

Operating: 0°F to 240°F (-17°C to 115°C)

Storage/Shipping:

-40°F to 240°F (-40°C to 115°C)

MATERIALS:

Main Components: Nickel-chrome plated brass

Valves and thumb latch: Polyphenylsulfone (PPSU)

Valve Springs (wetted): Stainless steel

External spring: Stainless steel

Seals: EPDM

Compliance: RoHS, REACH

COLOR: Chrome with Black

TUBING SIZES: 5/8" ID (15.9 mm ID)

LUBRICANTS: Krytox® PFPE

FORCE TO CONNECT: 21 lbs. typical at 0 psi

SPILLAGE:

0.02 cc per disconnect rated at 0 psi

0.07 cc per disconnect rated at 60 psi

AIR INCLUSION: 0.50 cc per connect

FLOW COEFFICIENT: Cv ~ 6.0 (5.2 Kv)

WARNING: Pressure, temperature, chemicals, and operating environment can affect the performance of couplings. It is the customer's responsibility to test the suitability of CPC's products in their own application conditions.

FEATURES

- Non-spill valve → Disconnect under pressure with no spills
- Redundant, multi-lobed seals → Extra protection from leak-causing contaminants and debris
- High flow capacity with low pressure drop → Efficient, cost-effective cooling
- EPDM seals → Compatibility with common coolants (e.g., glycol/water)
- Ergonomic body and latch design → Simple, intuitive, one-handed operation
- Audible click → Connection assurance
- Low profile → Meets size requirements for space-constrained electronics applications
- Single-piece options for insert and body → Space saving

BENEFITS

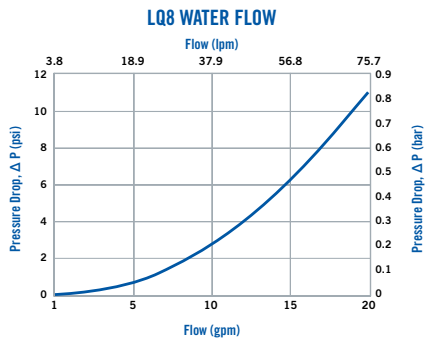

These graphs are intended to give you a general idea of the performance capabilities of each product line. Contact CPC for flow of a particular coupling combination.

DID YOU KNOW

Not all elastomers are compatible with all fluids used in liquid cooling. And low temperature seals may be needed for frigid environments.



cpcworldwide.com/Everis-LQ8

EVERIST™ LQ8 SERIES DIMENSIONS

COUPLING BODIES - Nickel-chrome plated brass



TERMINATION	TUBING/THREAD SIZE	METRIC EQ.	SHUTOFF	HEX	A	B	C
IN-LINE LOCKING HOSE BARB	5/8" ID	15.9 mm ID	LQ8D17010L		1.58 (40.1)	4.25 (108.0)	2.73 (69.3)
IN-LINE STRAIGHT THREAD SAE	3/4 SAE-12: 1-1/16-12 ^{1,3}		LQ8D30012	1 - 1/4"	1.58 (40.1)	2.58 (65.6)	2.15 (54.6)
IN-LINE STRAIGHT THREAD G / BSPP	G 3/4 ²		LQ8D31012		1.58 (40.1)	3.30 (83.8)	2.80 (71.1)

COUPLING INSERTS - Nickel-chrome plated brass



TERMINATION	TUBING/THREAD SIZE	METRIC EQ.	SHUTOFF	HEX	A	B	C
IN-LINE LOCKING HOSE BARB	5/8" ID	15.9 mm ID	LQ8D22010L		1.30 (33.0)	4.00 (101.6)	0.80 (20.4)
IN-LINE STRAIGHT THREAD SAE	3/4 SAE-12: 1-1/16-12 ^{1,3}		LQ8D46012	1 - 1/4"	1.30 (33.0)	2.40 (61.0)	0.22 (5.6)
IN-LINE STRAIGHT THREAD G / BSPP	G 3/4 ^{2,3}		LQ8D47012	34mm	1.40 (35.6)	2.40 (61.0)	0.22 (5.6)

All measurements are in inches (millimeters) unless otherwise noted.

¹All SAE terminations are compatible with SAE J1926-1 ports.

²All G (BSPP) terminations are compatible with ISO 1179-1 ports.

³One-piece design

PRODUCT DIMENSIONS

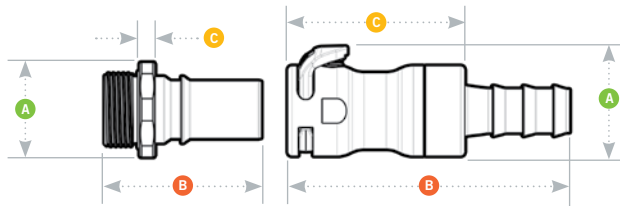

- A** = Height/Diameter
- B** = Total Length
- C** = Connected Length

Why Chemical Compatibility is Critical

Download tech guide to learn about component material compatibility and liquid cooling system performance.



READ TECH GUIDE →



cpcworldwide.com/LC-Chem-Comp-Guide

EVERIS™ PLQ2 SERIES CONNECTOR

Everis™ PLQ2 Series quick disconnect couplings are purpose-built for liquid cooling of electronics applications and offer a high-flow capacity to optimize thermal management system performance. Everis PLQ2 connector is lightweight, not susceptible to galvanic corrosion and is made of PPSU which is rated UL94 V0 flame retardant. With an ergonomic thumb latch, Everis PLQ2 fittings are easy to use. Everis PLQ2 quick disconnects' patented design offers reliable long-term connections and the non-spill valves provide drip-free connections and disconnections.



SPECIFICATIONS

PRESSURE:

Vacuum to 120 psi, 8.3 bar

TEMPERATURE:

Operating: 0°F to 240°F (-17°C to 115°C)

Storage/Shipping:
-40°F to 240°F (-40°C to 115°C)

MATERIALS:

Main Components: Polyphenylsulfone (PPSU)

Valves and Thumb latch: PPSU

Valve Springs (wetted): Stainless steel

External spring: Stainless steel

Seals: EPDM

Seal Spacer: PTFE

Compliance: RoHS, REACH

COLOR:

Matte Black with Cool Blue or Warm Red

TUBING SIZES: 1/4" ID (6.4mm ID)

LUBRICANTS: Krytox® PFPE

SPILLAGE:

<0.015 cc per disconnect at 0 psi

<0.063 cc per disconnect rated at 200 psi

AIR INCLUSION: 0.04 cc per connect

FLOW COEFFICIENT: Cv ~ 0.4 (0.3 Kv)

WARNING: Pressure, temperature, chemicals, and operating environment can affect the performance of couplings. It is the customer's responsibility to test the suitability of CPC's products in their own application conditions.

FEATURES

Made of high-performance PPSU material

Non-spill valve design

High flow to size ratio with low pressure drop

Ergonomic body and latch design

Audible click upon connection

Robust product testing

Color coding

Shrouded latch protection

BENEFITS

Lightweight, durable and chemically compatible with widely used liquid cooling fluids; UL94 V0 flame retardant

Disconnect under pressure with no spills

Increased cooling efficiency in small spaces

Simple, intuitive one-handed operation

Provides connection assurance

High durability and reliability in long-use applications

Instant visual identification of cooling lines

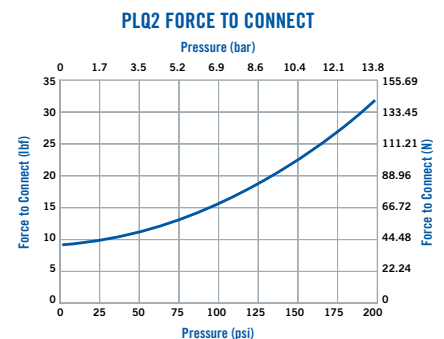
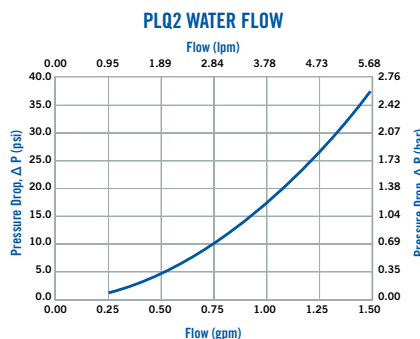

Prevention from accidental disconnect





These graphs are intended to give you a general idea of the performance capabilities of each product line. Contact CPC for flow of a particular coupling combination.

EVERIS™ PLQ2 SERIES DIMENSIONS

COUPLING BODIES - Polyphenylsulfone PPSU

TERMINATION	TUBING/THREAD SIZE	METRIC EQ.	SHUTOFF	A	B	C	TORQUE ³
 IN-LINE LOCKING HOSE BARB	1/4" ID	6.4mm ID	PLQ2D1704LRED	0.85 (22.0)	2.10 (53.3)	1.35 (34.2)	N/A
			PLQ2D1704LBLU	0.85 (22.0)	2.10 (53.3)	1.35 (34.2)	N/A
 IN-LINE STRAIGHT THREAD SAE	1/4 SAE-4: 7/16-20 ^{1,3}		PLQ2D3004RED	0.85 (22.0)	1.71 (43.4)	1.35 (34.2)	12 lb-in
			PLQ2D3004BLU	0.85 (22.0)	1.71 (43.4)	1.35 (34.2)	12 lb-in
 IN-LINE STRAIGHT THREAD G / BSPP	G 1/8 ^{2,3}		PLQ2D3102RED	0.85 (22.0)	1.65 (41.9)	1.40 (35.6)	12 lb-in
			PLQ2D3102BLU	0.85 (22.0)	1.65 (41.9)	1.40 (35.6)	12 lb-in

COUPLING INSERTS - Polyphenylsulfone PPSU

TERMINATION	TUBING/THREAD SIZE	METRIC EQ.	SHUTOFF	A	B	C	TORQUE ³
 IN-LINE LOCKING HOSE BARB	1/4" ID	6.4mm ID	PLQ2D2204LRED	0.63 (15.9)	1.91 (48.4)	0.39 (9.8)	N/A
			PLQ2D2204LBLU	0.63 (15.9)	1.91 (48.4)	0.39 (9.8)	N/A
 IN-LINE STRAIGHT THREAD SAE	1/4 SAE-4: 7/16-20 ^{1,3}		PLQ2D4604RED	0.63 (15.9)	1.52 (38.5)	0.39 (9.8)	12 lb-in
			PLQ2D4604BLU	0.63 (15.9)	1.52 (38.5)	0.39 (9.8)	12 lb-in
 IN-LINE STRAIGHT THREAD G / BSPP	G 1/8 ^{2,3}		PLQ2D4702RED	0.63 (15.9)	1.46 (37.0)	0.44 (11.1)	12 lb-in
			PLQ2D4702BLU	0.63 (15.9)	1.46 (37.0)	0.44 (11.1)	12 lb-in

All measurements are in inches (millimeters) unless otherwise noted. Tubing must meet stated inside and outside diameters.

¹All SAE terminations are compatible with SAE J1926-1 ports.

²All G (BSPP) terminations are compatible with ISO 1179-1 ports.

³Do not exceed torque value due to potential damage to coupling. User should consider application factors such as mating material, media, temperature, etc. when implementing an installation torque specification for the product.

PRODUCT DIMENSIONS

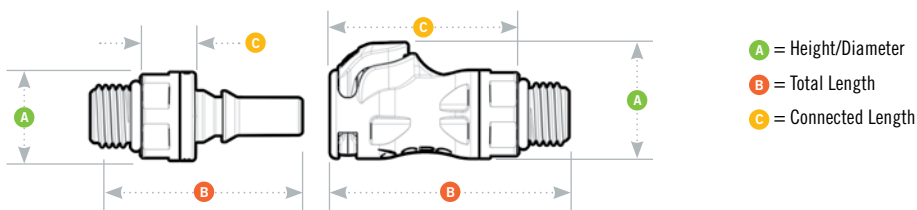

cpcworldwide.com/Everis-PLQ2



Pinnacle Products

Top notch ease of use, CPC Everis brand quick disconnects (QDs) meet the demands for high performance in liquid cooling.



EVERIS™ PLQ4 SERIES CONNECTOR

Everis™ PLQ4 Series quick disconnect couplings are purpose-built for liquid cooling of electronics applications and offer a high-flow capacity to optimize thermal management system performance. Made of PPSU, a high-performance, engineered thermoplastic, Everis PLQ4 connectors are lightweight, and not susceptible to galvanic corrosion. With an ergonomic thumb latch, Everis PLQ4 are easy to use. The couplings' patented design offers reliable long-term connections and the non-spill valves provide drip-free connections and disconnections to protect sensitive equipment.



SPECIFICATIONS

PRESSURE:

Vacuum to 120 psi, 8.3 bar

TEMPERATURE:

Operating: 0°F to 240°F (-17°C to 115°C)

Storage/Shipping:

-40°F to 240°F (-40°C to 115°C)

MATERIALS:

Main Components: Polyphenylsulfone PPSU

Valves and Thumb latch: PPSU

Valve Springs (wetted): Stainless steel

External spring: Stainless steel

Seals: EPDM

Seal Spacer: PTFE

Compliance: RoHS, REACH

COLOR:

Matte Black with Cool Blue or Warm Red

TUBING SIZES:

1/4" to 3/8" ID (6.4mm to 9.5mm ID)

LUBRICANTS:

Krytox® PFPE

SPILLAGE:

<0.025 cc per disconnect at 0 psi

<0.055 cc per disconnect rated at 120 psi

AIR INCLUSION:

0.20 cc per connect

FLOW COEFFICIENT:

$C_v \sim 1.4$ (1.2Kv)

WARNING: Pressure, temperature, chemicals, and operating environment can affect the performance of couplings. It is the customer's responsibility to test the suitability of CPC's products in their own application conditions.

FEATURES

Made of high-performance PPSU material

Non-spill valve

High flow to size ratio with low pressure drop

Ergonomic body and latch design

Audible click upon connection

Robust product testing

Color coding

Shrouded latch protection

BENEFITS

Lightweight, durable and chemically compatible with widely used liquid cooling fluids; UL94 V0 flame retardant

Disconnect under pressure with no spills

Increased cooling efficiency in small spaces

Simple, intuitive one-handed operation

Provides connection assurance

High durability and reliability in long-use applications

Instant visual identification of cooling lines

Prevention from accidental disconnect

PLQ4 WATER FLOW (0-20 GPM)

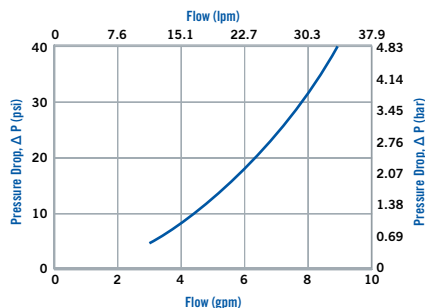



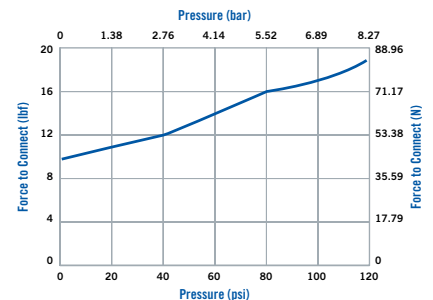

PLQ4 FORCE TO CONNECT







These graphs are intended to give you a general idea of the performance capabilities of each product line. Contact CPC for flow of a particular coupling combination.

EVERIS™ PLQ4 SERIES DIMENSIONS

COUPLING BODIES - Polyphenylsulfone PPSU

TERMINATION	TUBING/THREAD SIZE	METRIC EQ.	PART NO.	A	B	C	TORQUE ³
	1/4" ID	6.4mm ID	PLQ4D17004RED	1.03 (26.1)	2.47 (62.6)	1.82 (46.1)	N/A
	1/4" ID	6.4mm ID	PLQ4D17004BLU	1.03 (26.1)	2.47 (62.6)	1.82 (46.1)	N/A
	3/8" ID	9.5mm ID	PLQ4D17006RED	1.03 (26.1)	2.47 (62.6)	1.82 (46.1)	N/A
	3/8" ID	9.5mm ID	PLQ4D17006BLU	1.03 (26.1)	2.47 (62.6)	1.82 (46.1)	N/A
	3/8" ID	9.5mm ID	PLQ4D17006LRED	1.03 (26.1)	2.69 (68.3)	1.82 (46.1)	N/A
	3/8" ID	9.5mm ID	PLQ4D17006LBLU	1.03 (26.1)	2.69 (68.3)	1.82 (46.1)	N/A
	1/4 SAE-4: 7/16-20 ^{1,3}	N/A	PLQ4D30004RED	1.03 (26.1)	2.19 (55.5)	1.83 (46.4)	12 lb-in
	1/4 SAE-4: 7/16-20 ^{1,3}	N/A	PLQ4D30004BLU	1.03 (26.1)	2.19 (55.5)	1.83 (46.4)	12 lb-in
	3/8 SAE-6: 9/16-18 ^{1,3}	N/A	PLQ4D30006RED	1.03 (26.1)	2.22 (56.3)	1.83 (46.4)	12 lb-in
	3/8 SAE-6: 9/16-18 ^{1,3}	N/A	PLQ4D30006BLU	1.03 (26.1)	2.22 (56.3)	1.83 (46.4)	12 lb-in
	G 1/4 ^{2,3}	N/A	PLQ4D31004RED	1.03 (26.2)	2.28 (57.9)	1.90 (48.3)	12 lb-in
	G 1/4 ^{2,3}	N/A	PLQ4D31004BLU	1.03 (26.2)	2.28 (57.9)	1.90 (48.3)	12 lb-in

COUPLING INSERTS - Polyphenylsulfone PPSU

TERMINATION	TUBING/THREAD SIZE	METRIC EQ.	PART NO.	A	B	C	TORQUE ³
	1/4" ID	6.4mm ID	PLQD4D22004RED	0.87 (22.1)	2.30 (58.4)	0.58 (14.8)	N/A
	1/4" ID	6.4mm ID	PLQD4D22004BLU	0.87 (22.1)	2.30 (58.4)	0.58 (14.8)	N/A
	3/8" ID	9.5mm ID	PLQD4D22006RED	0.87 (22.1)	2.30 (58.4)	0.58 (14.8)	N/A
	3/8" ID	9.5mm ID	PLQD4D22006BLU	0.87 (22.1)	2.30 (58.4)	0.58 (14.8)	N/A
	3/8" ID	9.5mm ID	PLQD4D22006LRED	0.87 (22.1)	2.53 (64.2)	0.58 (14.8)	N/A
	3/8" ID	9.5mm ID	PLQD4D22006LBLU	0.87 (22.1)	2.53 (64.2)	0.58 (14.8)	N/A
	1/4 SAE-4: 7/16-20 ^{1,3}	N/A	PLQD4D46004RED	0.87 (22.1)	2.02 (51.3)	0.59 (15.1)	12 lb-in
	1/4 SAE-4: 7/16-20 ^{1,3}	N/A	PLQD4D46004BLU	0.87 (22.1)	2.02 (51.3)	0.59 (15.1)	12 lb-in
	3/8 SAE-6: 9/16-18 ^{1,3}	N/A	PLQD4D46006RED	0.87 (22.1)	2.02 (51.3)	0.59 (15.1)	12 lb-in
	3/8 SAE-6: 9/16-18 ^{1,3}	N/A	PLQD4D46006BLU	0.87 (22.1)	2.02 (51.3)	0.59 (15.1)	12 lb-in
	G 1/4 ^{2,3}	N/A	PLQD4D47004RED	0.87 (22.1)	2.11 (53.6)	0.67 (17)	12 lb-in
	G 1/4 ^{2,3}	N/A	PLQD4D47004BLU	0.87 (22.1)	2.11 (53.6)	0.67 (17)	12 lb-in

PRODUCT DIMENSIONS

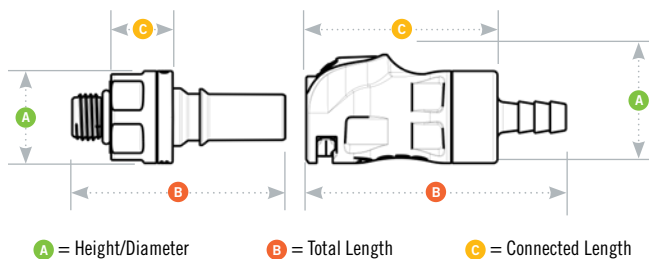

All measurements are in inches (millimeters) unless otherwise noted.

¹All SAE terminations are compatible with SAE J1926-1 ports.

²All G (BSPP) terminations are compatible with ISO 1179-1 ports.

³Do not exceed torque value due to potential damage to coupling. User should consider application factors such as mating material, media, temperature, etc. when implementing an installation torque specification for the product.



cpcworldwide.com/Everis-PLQ4

EVERIS™ BLQ2 SERIES CONNECTOR

Everis™ BLQ2 Series quick disconnect couplings provide ultra-reliable, dripless connections and disconnections that protect valuable electronics. Designed specifically for rack mounted liquid cooling applications, the Everis BLQ2 utilizes patented technology that eliminates drips and is able to withstand long-term connection.



SPECIFICATIONS

PRESSURE:

Vacuum to 200 psi, 13.8 bar

TEMPERATURE:

Operating: 0°F to 240°F (-17°C to 115°C)

Storage/Shipping:

-40°F to 240°F (-40°C to 115°C)

MAXIMUM FLOW AT DISCONNECT:

1.00 gal/min at 0 - 100 psi

.025 gal/min at 101 - 200 psi

MATERIALS:

Main Components:

Nickel-chrome plated brass

Valves: Polysulfone

Valve Springs (wetted): Stainless steel

Seals: EPDM

Compliance: RoHS, REACH

COLOR: Chrome

THREAD SIZES: 1/4" SAE-4

LUBRICANTS: Krytox® PFPE

SPILLAGE:

<0.015 cc per disconnect at 0 psi;

<0.063 cc per disconnect at 200 psi

AIR INCLUSION: <0.04 cc per connect

FLOW COEFFICIENT: Cv ~ 0.4 (0.3 Kv)

WARNING: Pressure, temperature, chemicals, and operating environment can affect the performance of couplings. It is the customer's responsibility to test the suitability of CPC's products in their own application conditions.

FEATURES

Non-spill valve



BENEFITS

Disconnect under pressure with no spills

Redundant multi-lobed seals



Extra protection from leak-causing contaminants and debris

Innovative valve design



Enables extended periods in connected state

Ruggedness



Able to withstand long-term, repeated use

Axial engagement tolerance



Allows full flow even when not fully engaged

Single-piece options for body & insert

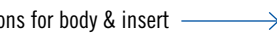

Space saving

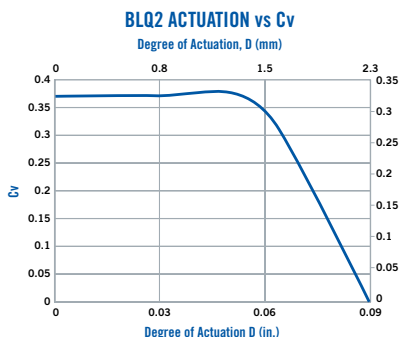
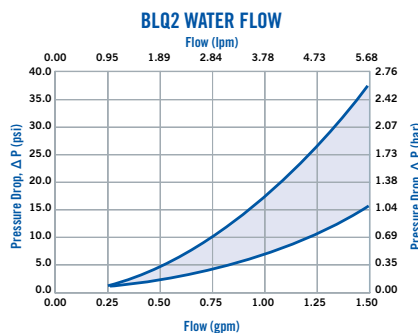

DID YOU KNOW

Evaluate QDs for liquid cooling applications by comparing their nominal flow coefficient (Cv or Kv.)

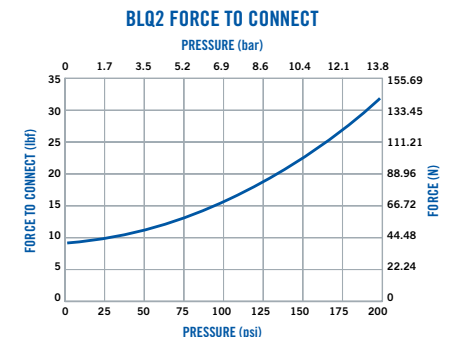

These graphs are intended to give you a general idea of the performance capabilities of each product line. Contact CPC for flow of a particular coupling combination.

EVERIS™ BLQ2 SERIES DIMENSIONS

COUPLING BODIES - Nickel-chrome plated brass



TERMINATION	TUBING/THREAD SIZE	METRIC EQ.	SHUTOFF	HEX	A	B	C
IN-LINE STRAIGHT THREAD SAE	1/4 SAE-4: 7/16-20 ^{1,2}	N/A	BLQ2D3004	9/16"	0.62 (15.7)	1.31 (33.3)	0.95 (24.1)

COUPLING INSERTS - Nickel-chrome plated brass



TERMINATION	TUBING/THREAD SIZE	METRIC EQ.	SHUTOFF	HEX	A	B	C
IN-LINE STRAIGHT THREAD SAE	1/4 SAE-4: 7/16-20 ^{1,2}	N/A	BLQ2D4604	9/16"	0.62 (15.7)	1.32 (33.3)	0.15 (3.8)

All measurements are in inches (millimeters) unless otherwise noted.

¹All SAE terminations are compatible with SAE J1926-1 ports

²One-piece design

PRODUCT DIMENSIONS



cpcworldwide.com/Everis-BLQ2

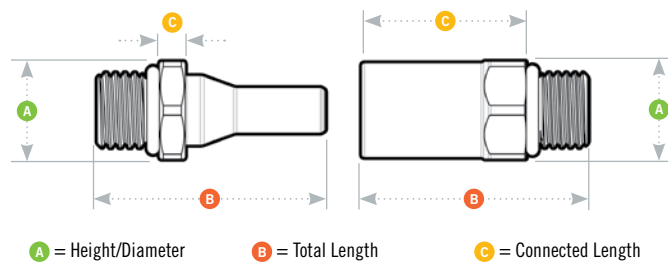

Everis™ QD Reliability

QDs designed for long-term, connected use with non-spill valves for dripless connection and disconnection.



EVERIS™ BLQ4 SERIES CONNECTOR



Everis™ BLQ4 Series quick disconnect couplings provide ultra-reliable, driplless connections and disconnections that protect valuable electronics. Designed specifically for rack mounted liquid cooling applications, Everis BLQ4 utilizes patented technology that eliminates drips and is designed for long-term connected use.

SPECIFICATIONS

PRESSURE:

Vacuum to 120 psi, 8.3 bar

TEMPERATURE:

Operating: 0°F to 240°F (-17°C to 115°C)

Storage/Shipping:

-40°F to 240°F (-40°C to 115°C)

MAXIMUM FLOW AT DISCONNECT:

3.0 gal/min, 11.3L/min

ENGAGEMENT TOLERANCE:

Coupling must be within 1/8" (3mm) of fully engaged to achieve maximum flow.

MATERIALS:

Main Components:

Nickel-chrome plated brass

Valves: Polysulfone

Valve Springs (wetted): Stainless steel

Seals: EPDM

Compliance: RoHS, REACH

THREAD SIZES:

Insert: G 1/4, G 3/8, SAE-4, SAE-6

Body: G 1/4, G 3/8, SAE-4, SAE-6, SAE-8

LUBRICANTS: Krytox® PFPE

SPILLAGE:

<0.025 cc per disconnect at 0 psi;

<0.055 cc per disconnect at 120 psi

AIR INCLUSION: 0.20 cc per connect

FLOW COEFFICIENT: Cv ~1.4 (1.2 Kv)

WARNING: Pressure, temperature, chemicals, and operating environment can affect the performance of couplings. It is the customer's responsibility to test the suitability of CPC's products in their own application conditions.

FEATURES

Non-spill valves

Redundant seals

Innovative valve design

Rugged construction

Axial engagement tolerance

Single-piece options for body & insert

BENEFITS

Disconnect under pressure with no spills

Extra protection from leak-causing contaminants and debris

Enables extended periods in connected state

Able to withstand long-term, repeated use

Allows full flow even when not fully engaged

Space saving

BLQ4 WATER FLOW (0-10 GPM)

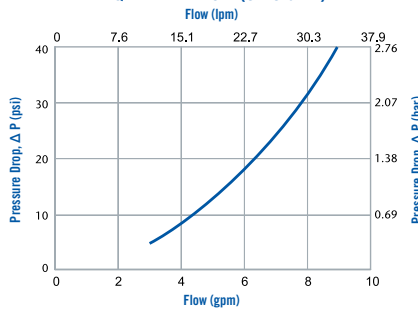

BLQ4 WATER FLOW (0-2 GPM)

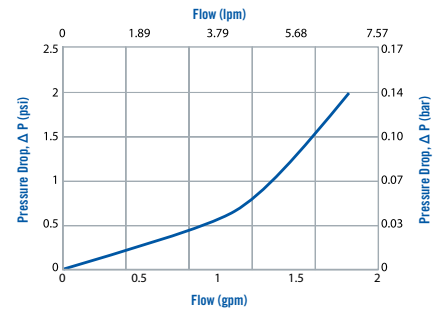

BLQ4 ACTUATION vs Cv

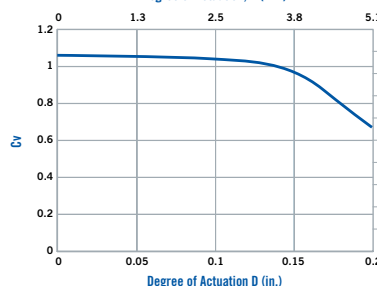

BLQ4 FORCE TO CONNECT

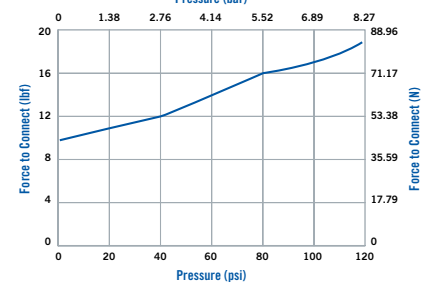

These graphs are intended to give you a general idea of the performance capabilities of each product line. Contact CPC for flow of a particular coupling combination.

EVERIS™ BLQ4 SERIES DIMENSIONS

COUPLING BODIES - Nickel-chrome plated brass



TERMINATION	TUBING/THREAD SIZE	METRIC EQ.	SHUTOFF	A	B	C
IN-LINE STRAIGHT THREAD SAE	1/4 SAE-4: 7/16-20 ¹	N/A	BLQ4D30004	0.93 (23.6)	2.05 (52.1)	1.64 (41.7)
	3/8 SAE-6: 9/16-18 ¹	N/A	BLQ4D30006	0.93 (23.6)	2.05 (52.1)	1.64 (41.7)
	1/2 SAE-8: 3/4-16 ^{1,3}	N/A	BLQ4D30008	0.90 (22.9)	1.60 (40.6)	1.16 (29.5)
IN-LINE STRAIGHT THREAD G / BSPP	G 1/4 (BSPP) ²	N/A	BLQ4D31004	0.93 (23.6)	2.11 (53.6)	1.70 (43.2)
	G 3/8 (BSPP) ²	N/A	BLQ4D31006	0.93 (23.6)	2.11 (53.6)	1.70 (43.2)

COUPLING INSERTS - Nickel-chrome plated brass



TERMINATION	TUBING/THREAD SIZE	METRIC EQ.	SHUTOFF	HEX	A	B	C
IN-LINE STRAIGHT THREAD SAE	1/4 SAE-4: 7/16-20 ¹	N/A	BLQ4D46004	22mm	0.93 (23.6)	1.99 (50.5)	0.69 (17.5)
	3/8 SAE-6: 9/16-18 ^{1,3}	N/A	BLQ4D46006	22mm	0.75 (19.1)	1.49 (37.8)	0.19 (4.8)
IN-LINE STRAIGHT THREAD G / BSPP	G 1/4 (BSPP) ²	N/A	BLQ4D47004	22mm	0.93 (23.6)	2.05 (52.1)	0.75 (19.1)
	G 3/8 (BSPP) ^{2,3}	N/A	BLQ4D47006	22mm	0.93 (23.6)	1.49 (37.8)	0.19 (4.8)

All measurements are in inches (millimeters) unless otherwise noted. Tubing must meet stated inside and outside diameters.

¹All SAE terminations are compatible with SAE J1926-1 ports.

²All G (BSPP) terminations are compatible with ISO 1179-1 ports.

³One-piece design.

PRODUCT DIMENSIONS



SCAN

cpcworldwide.com/Everis-BLQ4

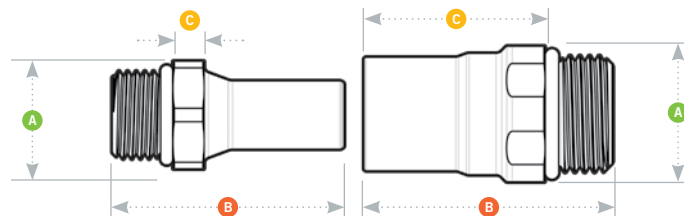

A = Height/Diameter

B = Total Length

C = Connected Length

Metal or plastic quick disconnects?

Download the tech guide to learn about performance, weight, and compatibility considerations.



READ TECH GUIDE →



cpcworldwide.com/LC-HP-Plastic-Guide

EVERIS™ BLQ6 SERIES CONNECTOR



Everis™ BLQ6 Series quick disconnect couplings Ultra-reliable, no-drip connections for thermal management to help protect valuable electronic systems. Designed specifically for blind mate liquid cooling applications, the BLQ6 Series uses patented technology that eliminates drips and is specifically designed to withstand long-term connection. An optional accessory kit is available for panel mount connections.

SPECIFICATIONS

PRESSURE: Vacuum to 120 psi, 8.3 bar

TEMPERATURE:

Operating: 0°F to 240°F (-17°C to 115°C)

Storage/Shipping:

-40°F to 240°F (-40°C to 115°C)

MAXIMUM FLOW AT DISCONNECT:

3.0 gal/min, 11.3L/min

ENGAGEMENT TOLERANCE:

Coupling must be within 1/8" of fully engaged to achieve maximum flow.

MATERIALS:

Main Components: Anodized Aluminum

Valves: Polysulfone

Valve Springs (wetted): Stainless steel

Seals: EPDM

Panel Mount Kit: Stainless steel

Compliance: RoHS, REACH

THREAD SIZES:

Insert: SAE-6, G 1/2

Body: SAE-6, G 1/2

LUBRICANTS: Krytox® PFPE

SPILLAGE:

<0.03 cc per disconnect at 0 psi;

<0.03 cc per disconnect at 120 psi

AIR INCLUSION: <0.022 cc per connect

FLOW COEFFICIENT: Cv ~ 2.2 (1.90 Kv)

AXIAL MISALIGNMENT: 1 mm max

WARNING: Pressure, temperature, chemicals and operating environment can affect the performance of couplings. It is the customer's responsibility to test the suitability of CPC's products in their own application conditions.

FEATURES

- Non-spill valve → Disconnect under pressure with no spills
- Redundant seals → Extra protection from leak-causing contaminants and debris
- Innovative valve design → Provides reliability for extended periods of operation
- Rugged anodized aluminum → Able to withstand long-term, ongoing and repeated use
- Axial engagement tolerance → Allows full flow even when not fully engaged
- Optional panel mount kit → Enables either the body, insert or both to be panel mounted

BENEFITS

BLQ6 WATER FLOW (0-20 GPM)

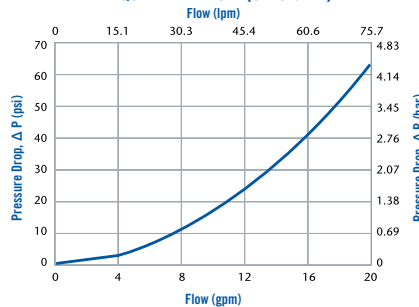

BLQ6 FORCE TO CONNECT

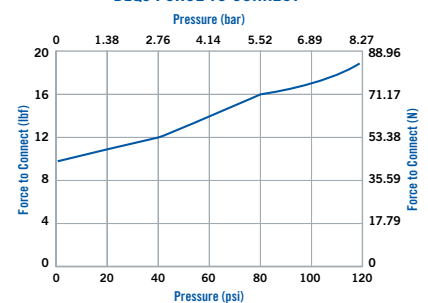

BLQ6 ACTUATION vs Cv

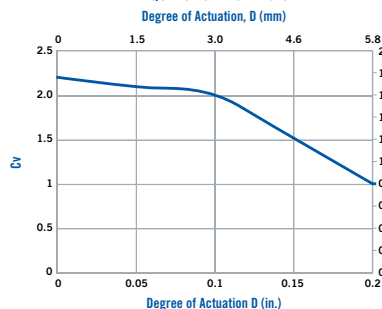

ACTUATION LENGTH

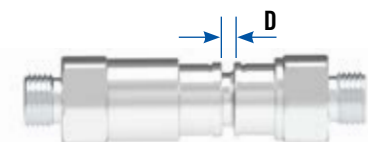

These graphs are intended to give you a general idea of the performance capabilities of each product line. Contact CPC for flow of a particular coupling combination.

EVERIS™ BLQ6 SERIES DIMENSIONS

COUPLING BODIES - Nickel-chrome plated brass



TERMINATION	TUBING/THREAD SIZE	METRIC EQ	SHUTOFF	HEX	A	B	C
IN-LINE STRAIGHT THREAD SAE	3/8 SAE-6: 9/16-18 ¹	N/A	BLQ6D30006	7/8"	0.96 (24.4)	2.08 (52.7)	1.68 (42.8)
IN-LINE STRAIGHT THREAD G / BSPP	G 1/2 ^{2,3}	N/A	BLQ6D31008	26mm	1.12 (28.4)	2.26 (57.5)	1.76 (44.7)

COUPLING INSERTS - Nickel-chrome plated brass



TERMINATION	TUBING/THREAD SIZE	METRIC EQ	SHUTOFF	HEX	A	B	C
IN-LINE STRAIGHT THREAD PORT SAE	3/8 SAE-6: 9/16-18 ¹	N/A	BLQ6D46006	7/8"	0.96 (24.4)	2.27 (57.7)	0.99 (25.2)
IN-LINE STRAIGHT THREAD G / BSPP	G 1/2 ^{2,3}	N/A	BLQ6D47008	26mm	1.12 (28.4)	2.00 (50.9)	0.70 (17.8)

All measurements are in inches (millimeters) unless otherwise noted.

¹All SAE terminations are compatible with SAE J1926-1 ports.

²All G (BSPP) terminations are compatible with ISO 1179-1 ports.

³One-piece design

PRODUCT DIMENSIONS

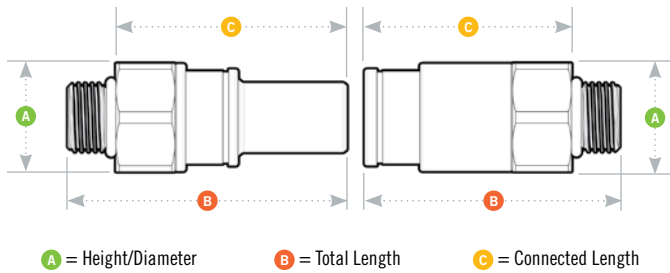

PANEL DIMENSIONS

PANEL OPENING	PANEL THICKNESS MAX.-MIN.
see drawing	0.075 -0.175"

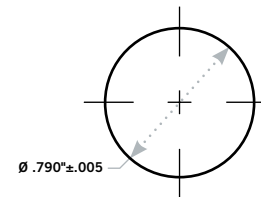

RADIAL TOLERANCE

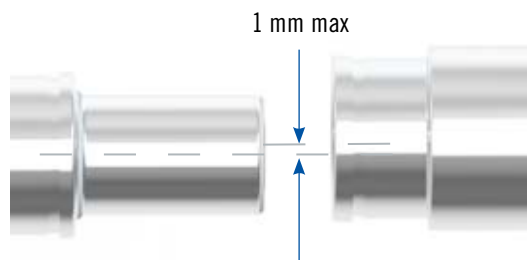

PANEL MOUNT KIT (P/N BLQ6PMKIT)

Kit includes wave spring and retainer ring only.

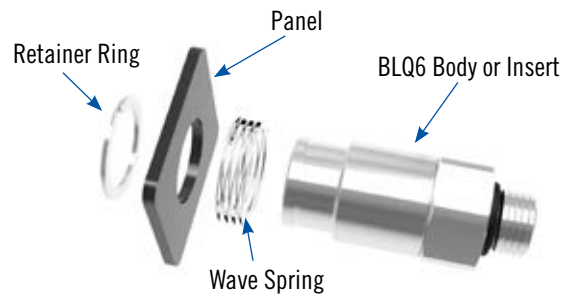

cpcworldwide.com/Everis-BLQ6

NS6 SERIES CONNECTOR

NS6 Series couplings couplings feature non-spill valves at a great price. Use the NS6 when even a few drops of spillage pose problems regarding safety, media cost or environmental regulations. These innovative couplings are lightweight, chemically resistant and easy to use. The non-spill design virtually eliminates spills and minimizes downtime. Soft touch overmold makes them comfortable in the hand and very attractive.



SPECIFICATIONS

PRESSURE:

Vacuum to 120 psi, 8.3 bar

TEMPERATURE:

32°F to 160°F (0°C to 71°C)

MATERIALS:

Main components and valves:

Glass-filled polypropylene with TPV* soft touch overmold

Thumb latch: Glass-filled polypropylene

Valve spring (wetted): 316 stainless steel

External spring: 316 stainless steel

O-rings: EPDM

COLOR:

Gray with dark gray overmold standard; gray with red or blue overmold available†

TUBING SIZES:

3/8" and 1/2" ID, 9.5mm and 12.7mm ID

LUBRICANTS: Krytox® PFPE (inert)

SPILLAGE:

~0.03 cc per disconnect @ 0 psi,

~0.30 cc/disconnect @ 120 psi

INCLUSION: 0.42 cc per connect

*The overmold material is a TPV (thermoplastic vulcanizate). This TPV is an alloy of polypropylene thermoplastic and fully vulcanized EPDM rubber. The material is typically resistant to water, acids and bases.

†NOTE: Standard product is gray; color options require a set-up charge and minimum quantities. Please contact CPC for details.

FEATURES

- Non-spill design → Disconnect under pressure with no spills
- Color coding → Instant visual differentiation of media lines
- Glass-filled polypropylene → Durable and compatible with many chemicals
- CPC thumb latch → One-hand connection and disconnection

BENEFITS

NS6 WATER FLOW

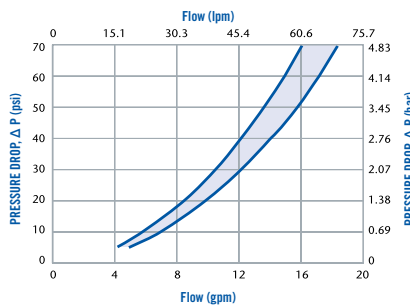

NS6 Pressure Range

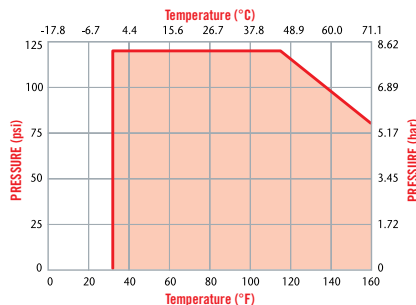



These graphs are intended to give you a general idea of the performance capabilities of each product line. The shaded area of each graph represents the operating range of the product family, i.e., upper and lower values are shown. Therefore, depending on the exact coupling configurations selected, you can reasonably expect values to fall within the shaded area.







cpcworldwide.com/NS6

NS6 SERIES DIMENSIONS

COUPLING BODIES - Polypropylene

TERMINATION	TUBING/THREAD SIZE	METRIC EQ.	SHUTOFF	A	B
 IN-LINE PIPE THREAD	1/2" NPT		NS6D10008	1.31 (33.3)	3.01 (76.5)
	1/2" BSPT		NS6D10008BSPT	1.31 (33.3)	3.01 (76.5)
 IN-LINE COMPRESSION	1/2" OD	12.7mm OD	NS6D13008	1.31 (33.3)	3.53 (89.7)
 IN-LINE HOSE BARB	3/8" ID	9.5mm ID	NS6D17006	1.31 (33.3)	3.16 (80.3)
	1/2" ID	12.7mm ID	NS6D17008	1.31 (33.3)	3.16 (80.3)

COUPLING INSERTS - Polypropylene

TERMINATION	TUBING/THREAD SIZE	METRIC EQ.	SHUTOFF	A	B
 IN-LINE PIPE THREAD	1/2" NPT		NS6D24008	1.31 (33.3)	2.44 (62.0)
	1/2" BSPT		NS6D24008BSPT	1.31 (33.3)	2.44 (62.0)
 IN-LINE COMPRESSION	1/2" OD	12.7mm OD	NS6D20008	1.31 (33.3)	3.01 (76.5)
 IN-LINE HOSE BARB	3/8" ID	9.5mm ID	NS6D22006	1.31 (33.3)	2.59 (65.8)
	1/2" ID	12.7mm ID	NS6D22008	1.31 (33.3)	2.59 (65.8)
 PANEL MOUNT COMPRESSION	1/2" OD	12.7mm OD	NS6D40008	1.50 (38.1)	3.32 (84.3)
 PANEL MOUNT HOSE BARB	3/8" ID	9.5mm ID	NS6D42006	1.50 (38.1)	2.85 (72.4)
	1/2" ID	12.7mm ID	NS6D42008	1.50 (38.1)	2.85 (72.4)

All measurements are in inches (millimeters) unless otherwise noted. Tubing must meet stated inside and outside diameters. Couplings are pictured with valves unless otherwise noted.

ACCESSORIES

DESCRIPTION	MATERIAL	PART NO.
PANEL MOUNT GASKET REPLACEMENT: FOR SEALING PANEL MOUNT BODIES LISTED ABOVE	EPDM	1884300
	FKM	1889600

PRODUCT DIMENSIONS

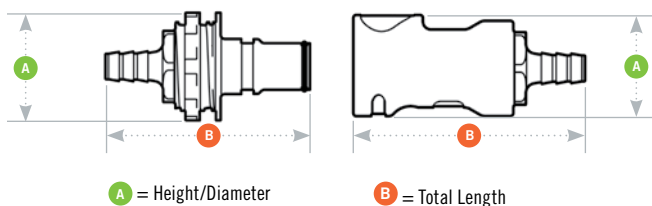

PANEL DIMENSIONS

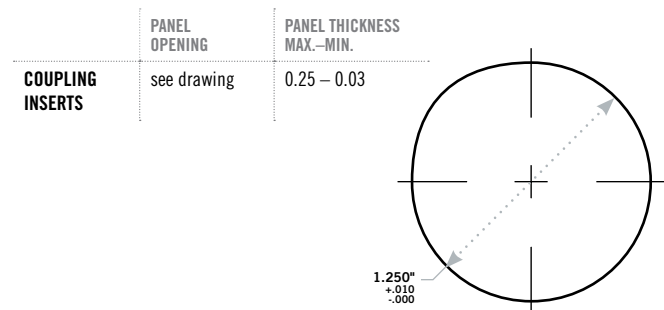

NSH SERIES CONNECTOR

NSH Series couplings are general purpose versions of our pressure-balanced, non-spill, ChemQuik® CQG06 couplings. Molded polypropylene, EPDM seals and a 100% springless and metal-free flow path provide broad chemical resistance and exceptionally high flow capacity, allowing instant disconnects (and reconnects), even under pressure. Their non-spill design virtually eliminates spills and minimizes downtime in a very low cost package.



SPECIFICATIONS

PRESSURE:

Vacuum to 120 psi, 8.3 bar

TEMPERATURE:

32°F to 120°F (0°C to 49°C)

MATERIALS:

Main components: Glass-filled polypropylene

Thumb latch: Glass-filled polypropylene

O-rings: EPDM

Springs (non-wetted): 316 stainless steel

Compression nuts: White polypropylene

COLOR:

Gray with dark gray accent standard; red or blue thumb latch and insert tip available.

TUBING SIZES:

3/8" to 3/4" ID, 9.5mm to 19.0mm ID

LUBRICANTS: Krytox® PFPE (inert)

SPILLAGE: 0.03 cc/connect

INCLUSION: 0.42 cc per connect

PANEL MOUNT:

Optional adaptor kit (see page 89)

WARNING: Pressure, temperature, chemicals, and operating environment can affect the performance of couplings. It is the customer's responsibility to test the suitability of CPC products in their own application conditions. Use the graphs below as a guide.

Compatible with ChemQuik® Dual Containment System; DrumQuik® Universal Dispense System and Asian Drum Adaptors.

FEATURES

- Non-spill design → Ultimate protection from chemicals and fumes
- Pressure-balanced design → Failsafe disconnect, even under pressure; easy to reconnect at high pressure
- Springless flow path design → Eliminates source of metallic contaminants
- Optional color coding → Helps prevent accidental misconnects

BENEFITS

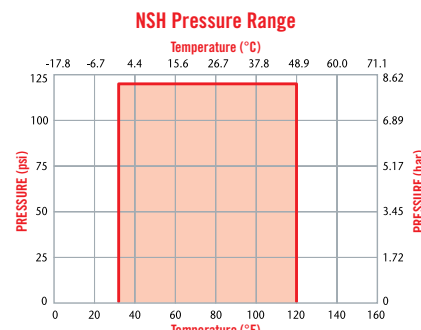
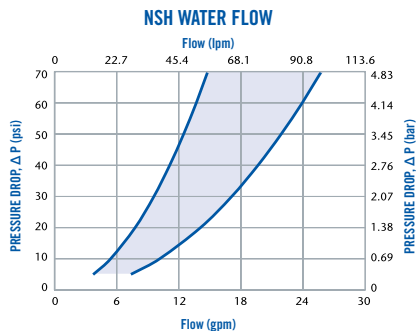



These graphs are intended to give you a general idea of the performance capabilities of each product line. The shaded area of each graph represents the operating range of the product family, i.e., upper and lower values are shown. Therefore, depending on the exact coupling configurations selected, you can reasonably expect values to fall within the shaded area.





cpcworldwide.com/NSH

NSH SERIES DIMENSIONS

COUPLING BODIES - Polypropylene

TERMINATION	TUBING/THREAD SIZE	METRIC EQ.	SHUTOFF	A	B
 IN-LINE PIPE THREAD	3/8" FEMALE NPT		NSHD19006	2 (50.8)	3.70
	1/2" NPT		NSHD10008	2 (50.8)	3.81
	3/4" NPT		NSHD10012	2 (50.8)	4.01
 IN-LINE COMPRESSION	3/8" OD	9.5mm OD	NSHD13006	2 (50.8)	3.97
	1/2" OD	12.7mm OD	NSHD13008	2 (50.8)	4.10
 IN-LINE HOSE BARB	3/8" ID	9.5mm ID	NSHD17006	2 (50.8)	3.73
	1/2" ID	12.7mm ID	NSHD17008	2 (50.8)	3.73
	5/8" ID	15.9mm ID	NSHD17010	2 (50.8)	3.88
	3/4" ID	19.0mm ID	NSHD17012	2 (50.8)	3.88

COUPLING INSERTS - Polypropylene

TERMINATION	TUBING/THREAD SIZE	METRIC EQ.	SHUTOFF	A	B
 IN-LINE PIPE THREAD	3/8" FEMALE NPT		NSHD26006	1.64 (41.7)	3.87 (98.3)
	3/8" BSPT		NSHD24006BSPT	1.64 (41.7)	3.84 (97.5)
	1/2" NPT		NSHD24008	1.64 (41.7)	3.98 (101.1)
	3/4" NPT		NSHD24012	1.64 (41.7)	3.98 (101.1)
 IN-LINE COMPRESSION	3/8" OD	9.5mm OD	NSHD20006	1.64 (41.7)	4.14 (105.2)
	1/2" OD	12.7mm OD	NSHD20008	1.64 (41.7)	4.27 (108.5)
 IN-LINE HOSE BARB	3/8" ID	9.5mm ID	NSHD22006	1.64 (41.7)	3.9 (99.1)
	1/2" ID	12.7mm ID	NSHD22008	1.64 (41.7)	3.9 (99.1)
	5/8" ID	15.9mm ID	NSHD22010	1.64 (41.7)	4.05 (102.9)
	3/4" ID	19.0mm ID	NSHD22012	1.64 (41.7)	4.05 (102.9)

All measurements are in inches (millimeters) unless otherwise noted. Tubing must meet stated inside and outside diameters. *Panel mount kit can be used with body for front mount or insert for front or rear mount.

ACCESSORIES



DESCRIPTION	PART NO.
PANEL MOUNT KIT: WITH PANEL SEAL DUST PLUG/CAP FOR BODY OR INSERT*	NSHPMKIT12 1800700 (not shown)

PRODUCT DIMENSIONS

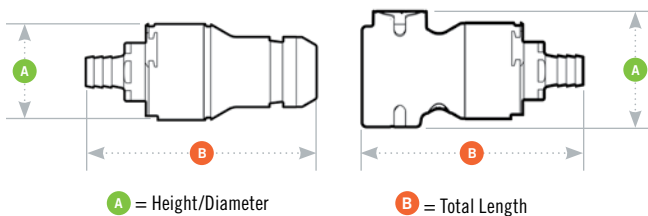

PANEL DIMENSIONS

	PANEL OPENING	PANEL THICKNESS MAX.—MIN.
COUPLING INSERTS	see drawing	0.50 – 0.12

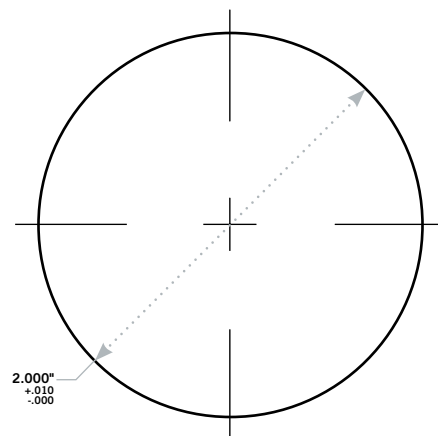

HFC12 SERIES CONNECTOR

HFC12 Series couplings have flow comparable to many 1/2" flow couplings in a 3/8" body size. Compact and lightweight, HFC couplings replace bulky and heavy brass ball-and-sleeve couplings in a wide range of applications. An ergonomic design and a large, shrouded thumb latch pad produce a coupling that is easy to grip and simple to operate. An efficient valve design leads to high flow and low spillage.



SPECIFICATIONS

PRESSURE:

Vacuum to 60 psi, 4.2 bar

TEMPERATURE:

32°F to 160°F (0°C to 71°C)

MATERIALS:

Main components and valves: Polypropylene

Thumb latch: Polypropylene

Valve spring (wetted): 316 stainless steel

External springs: 316 stainless steel

O-rings: EPDM

Panel mount gasket: EPDM

Compression nut, gripper, ferrule:
Polypropylene

COLOR: Gray with dark gray latch

TUBING SIZES:

3/8" to 3/4" ID, 9.5mm to 19.0mm ID

WARNING: Pressure, temperature, chemicals, and operating environment can affect the performance of couplings. It is the customer's responsibility to test the suitability of CPC's products in their own application conditions. For compression termination specifications: 3/8" OD or 1/2" OD, +0.010/-0.000



cpcworldwide.com/HFC12

FEATURES

- High efficiency valve → More flow in a compact size
- Ergonomic design → Easy to grip, simple to operate
- Polypropylene material → Chemically resistant and gamma sterilizable
- Compatible → Mates with HFC35 and HFC57 couplings

BENEFITS

NOTE

Optional o-ring and spring materials are available, please contact CPC for details.

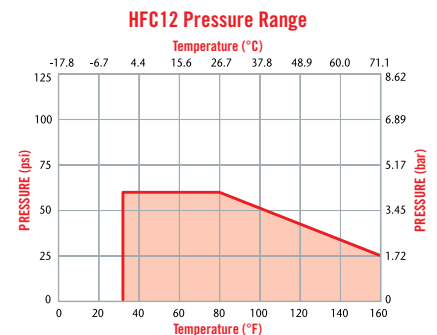
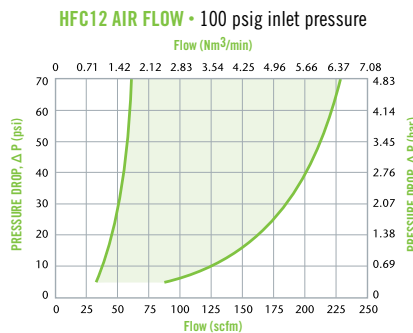
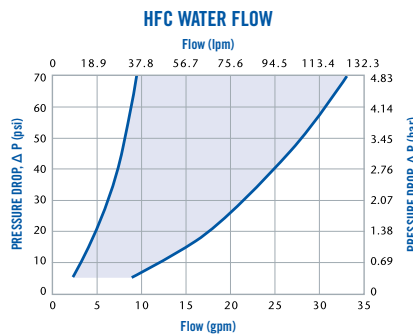

These graphs are intended to give you a general idea of the performance capabilities of each product line. The shaded area of each graph represents the operating range of the product family, i.e., upper and lower values are shown. Therefore, depending on the exact coupling configurations selected, you can reasonably expect values to fall within the shaded area.



NSF OPTION AVAILABLE

This product has an NSF compatible product for food applications. Our food-grade couplings are superior to general fittings for fluid control because they incorporate built-in shutoff valves, enabling tubing to be disconnected without having to turn off the water supply. Scan the QR code to be taken to the NSF specific product web page.



LIQUID FLOW RATE INFORMATION FOR COUPLINGS

The chart below shows the flow rate for CPC couplings. Each coupling was tested with water at 70°F (21°C). To determine flow rates for specific coupling configurations use the formula to the right.

$$Q = C_v \sqrt{\frac{\Delta P}{S}}$$

- Q = Flow rate in gallons per minute
- C_v = Average coefficient across various flow rates (see chart)
- ΔP = Pressure drop across coupling (psi)
- S = Specific gravity of liquid





C_v VALUES

INSERTS

	HFC 22612	HFCD 22612	HFC 22812	HFCD 22812	HFC 23612	HFCD 23612	HFC 23812	HFCD 23812	HFC 24612	HFCD 24612	HFC 24812	HFCD 24812	HFC 221212	HFC 221212
BODIES														
HFCD10612	1.27	1.27	1.62	1.51	1.14	1.14	1.46	1.36	1.80	1.58	1.70	1.65	-	-
HFCD10812	1.28	1.34	1.62	1.51	1.15	1.24	1.46	1.36	1.81	1.54	1.72	1.56	-	-
HFCD16612	1.07	1.00	1.17	1.14	0.96	0.90	1.05	1.03	1.33	1.26	1.30	1.24	-	-
HFCD16812	1.25	1.23	1.61	1.52	1.13	1.11	1.45	1.37	1.79	1.60	1.68	1.56	-	-
HFCD17612	1.07	1.00	1.17	1.14	0.96	0.90	1.05	1.03	1.33	1.26	1.30	1.24	-	-
HFCD17812	1.25	1.23	1.61	1.52	1.13	1.11	1.45	1.37	1.79	1.60	1.68	1.56	-	-
HFC171212	-	-	-	-	-	-	-	-	-	-	-	-	3.94	-
HFCD171212	-	-	-	-	-	-	-	-	-	-	-	-	-	2.04

HFC12 SERIES DIMENSIONS

COUPLING BODIES - Polypropylene

TERMINATION	TUBING/THREAD SIZE	METRIC EQ	STRAIGHT THRU	SHUTOFF	A	B
 IN-LINE PIPE THREAD	3/8" NPT		HFC10612	HFCD10612	1.44 (36.6)	2.69 (68.3)
	3/8" BSPT		HFC10612BSPT	HFCD10612BSPT	1.44 (36.6)	2.72 (69.1)
	1/2" NPT		HFC10812	HFCD10812	1.44 (36.6)	2.88 (73.2)
	3/4" NPT		HFC101212	HFCD101212	1.44 (36.6)	3.07 (78.0)
 BULKHEAD PANEL MOUNT HOSE BARB	3/8" ID	9.5mm ID	HFC16612	HFCD16612	1.82 (46.2)	2.82 (71.6)
	1/2" ID	12.7mm ID	HFC16812	HFCD16812	1.82 (46.2)	2.82 (71.6)
	5/8" ID	15.9mm ID	HFC161012	HFCD161012	1.82 (46.2)	2.94 (74.7)
	3/4" ID	19.0mm ID	HFC161212	HFCD161212	1.82 (46.2)	2.94 (74.7)
 BULKHEAD PANEL MOUNT COMPRESSION	3/8" OD	9.5mm OD	HFC12612	HFCD12612	1.82 (46.2)	2.96 (75.2)
	1/2" OD	12.7mm OD	HFC12812	HFCD12812	1.82 (46.2)	3.11 (79.0)
 IN-LINE HOSE BARB	3/8" ID	9.5mm ID	HFC17612	HFCD17612	1.44 (36.6)	2.79 (70.9)
	1/2" ID	12.7mm ID	HFC17812	HFCD17812	1.44 (36.6)	2.79 (70.9)
	5/8" ID	15.9mm ID	HFC171012	HFCD171012	1.44 (36.6)	2.94 (74.7)
	3/4" ID	19.0mm ID	HFC171212	HFCD171212	1.44 (36.6)	2.94 (74.7)
 IN-LINE COMPRESSION	3/8" OD	9.5mm OD		HFCD13612	1.44 (36.6)	2.96 (75.2)
	1/2" OD	12.7mm OD	HFC13812	HFCD13812	1.44 (36.6)	3.11 (79.0)

All measurements are in inches (millimeters) unless otherwise noted. Tubing must meet stated inside and outside diameters.

ACCESSORIES

DESCRIPTION	MATERIAL	PART NO.
PANEL MOUNT GASKET REPLACEMENT: FOR SEALING PANEL MOUNT BODIES LISTED ABOVE	EPDM	621200

PRODUCT DIMENSIONS

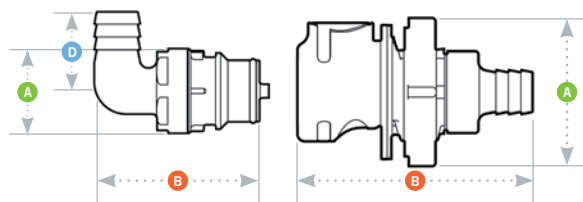



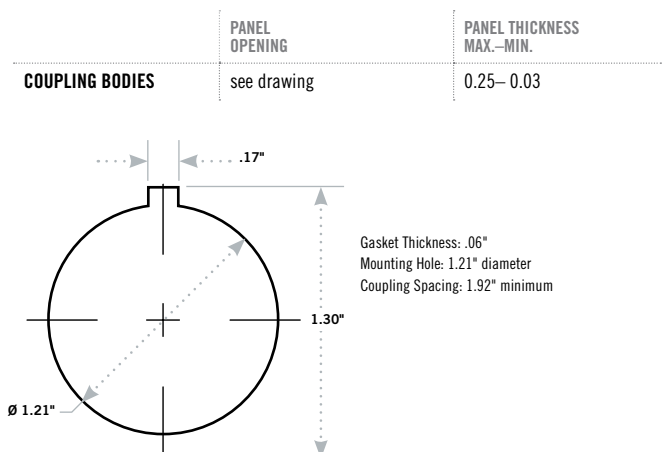

- A = Height/Diameter
- B = Total Length
- D = Elbow Radial Length

PANEL DIMENSIONS



COUPLING INSERTS - Polypropylene

TERMINATION	TUBING/THREAD SIZE	METRIC EQ	STRAIGHT THRU	SHUTOFF	A	B	D
 IN-LINE PIPE THREAD	3/8" NPT		HFC24612	HFCD24612	1.16 (29.5)	1.77/1.89 (45.0/48.0)	
	3/8" BSPT		HFC24612BSPT	HFCD24612BSPT	1.16 (29.5)	1.80/1.92 (45.7/48.8)	
	1/2" NPT		HFC24812	HFCD24812	1.16 (29.5)	1.95/2.07 (49.5/52.6)	
	3/4" NPT		HFC241212	HFCD241212	1.23 (31.2)	2.14/2.26 (54.4/57.4)	
 IN-LINE HOSE BARB (NON-VALVED SHOWN)	3/8" ID	9.5mm ID	HFC22612	HFCD22612	1 (25.4)	1.97/2.09 (50.0/53.1)	
	1/2" ID	12.7mm ID	HFC22812	HFCD22812	1 (25.4)	1.97/2.09 (50.0/53.1)	
	5/8" ID	15.9mm ID	HFC221012	HFCD221012	1 (25.4)	2.01/2.13 (51.1/54.1)	
	3/4" ID	19.0mm ID	HFC221212	HFCD221212	1 (25.4)	2.14/2.26 (54.4/57.4)	
 IN-LINE COMPRESSION (NON-VALVED SHOWN)	3/8" OD	9.5mm OD	HFC20612	HFCD20612	1 (25.4)	2.14/2.26 (54.4/57.4)	
	1/2" OD	12.7mm OD	HFC20812	HFCD20812	1 (25.4)	2.29/2.41 (58.2/61.2)	
 ELBOW HOSE BARB (NON-VALVED SHOWN)	3/8" ID	9.5mm ID	HFC23612	HFCD23612	1 (25.4)	1.93/2.05 (49.0/52.1)	0.93 (23.6)
	1/2" ID	12.7mm ID	HFC23812	HFCD23812	1 (25.4)	1.97/2.09 (50.0/53.1)	0.93 (23.6)
	3/4" ID	19.0mm ID	HFC231212	HFCD231212	1 (25.4)	1.95/2.07 (49.5/52.6)	0.93 (23.6)

All measurements are in inches (millimeters) unless otherwise noted. Tubing must meet stated inside and outside diameters. Couplings are pictured with valves unless otherwise noted.

DID YOU KNOW

When selecting a valved coupling for your application, make sure to order a part number with a D just before the numeric portion of the part number. For example, HFC101212 does not have a shutoff valve; HFCD101212 would be the correct part number to order for a valved coupling.

To visually identify a part to determine whether or not it is valved, disconnect the coupling body and insert, and then look through the part. If you can see light all the way through, your part is non-valved. If there is anything obstructing the light, you probably have a valved part. Please contact Customer Service at 1-800-444-2474 or 651-645-0091 if you need further assistance.

HFC35 & 57 SERIES CONNECTORS

HFC35 Series polysulfone couplings are able to withstand demanding applications and feature physical strength, chemical resistance and autoclavability.

HFC57 Series polysulfone couplings are UV resistant and able to withstand continued exposure to harmful UV rays without affecting performance.

Both can operate in harsh environments in temperatures from -40°F to 280°F (-40°C to 138°C) and pressures from vacuum to 125 psi (8.6 bar). An ergonomic design and a large, shrouded thumb latch produce a coupling that is easy to grip and simple to operate. An efficient valve design leads to high flow and exceptionally low spillage. Both series also add bulkhead panel mount, garden hose thread and Hastelloy® C spring options.



SPECIFICATIONS

PRESSURE:

Vacuum to 125 psi, 8.6 bar

TEMPERATURE:

-40°F to 280°F (-40°C to 138°C)

MATERIALS:

Main components and valves:

HFC35 - Polysulfone

HFC57 - UV-resistant polysulfone

THUMB LATCH:

HFC35 - Polysulfone

HFC57 - UV-resistant polysulfone

Valve spring: 316 stainless steel

External springs: 316 stainless steel

O-rings: EPDM

Panel mount gasket: EPDM

Female GHT gasket: FDA EPDM

COLORS:

HCF35 - Natural white, dark gray latch

HCF57 - Black, black latch

TUBING SIZES:

3/8" to 3/4" ID, 9.5mm to 19.0mm ID

WARNING: Pressure, temperature, chemicals, and operating environment can affect the performance of couplings. It is the customer's responsibility to test the suitability of CPC products in their own application conditions. Use the graphs on the following page as a guide. For compression termination specifications: 3/8" OD or 1/2" OD, +0.010/-0.000

FEATURES

Polysulfone (HFC35)



BENEFITS

Physically strong and autoclavable

UV Polysulfone (HFC57)



Physically strong and UV resistant

High efficiency valve



More flow and less spillage in a compact size

Ergonomic design



Easy to grip, simple to operate

Compatible



Mates with HFC12 couplings

DID YOU KNOW

The HFC57 Series polysulfone couplings are UV-resistant and able to withstand continued exposure to harmful rays without affecting performance.

These couplings offer all the same features as our HFC12 and HFC35 Series with the added advantage of UV-resistance to protect the strength and durability of your fluid connections. Use the HFC57 couplings in outdoor applications such as watercraft, lawn irrigation systems and solar heating on roofs and decks where a connector is subjected to the harsh rays of the sun.



cpcworldwide.com/HFC35-57



Also available in NSF listed versions for food-based applications, please visit our website for part number information.



NSF OPTION AVAILABLE

This product has an NSF compatible product for food applications. Our food-grade couplings are superior to general fittings for fluid control because they incorporate built-in shutoff valves, enabling tubing to be disconnected without having to turn off the water supply. Scan the QR code to be taken to the NSF specific product web page.



HFC35/57 AIR FLOW • 100 psig inlet pressure

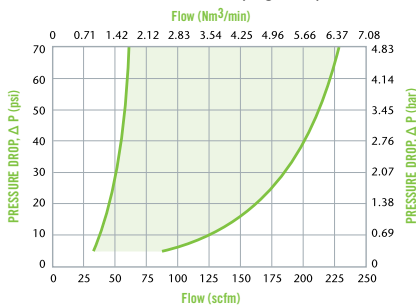

HFC 35/57 WATER FLOW

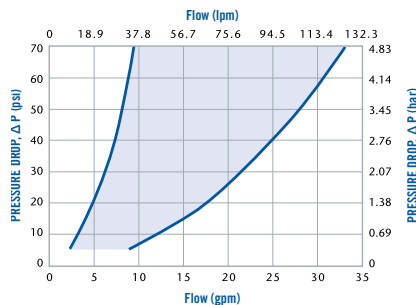



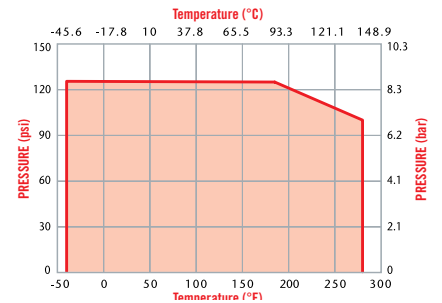

HFC35/37 Pressure Range







These graphs are intended to give you a general idea of the performance capabilities of each product line. The shaded area of each graph represents the operating range of the product family, i.e., upper and lower values are shown. Therefore, depending on the exact coupling configurations selected, you can reasonably expect values to fall within the shaded area.

HFC35 SERIES DIMENSIONS

COUPLING BODIES - Polysulfone

TERMINATION	TUBING/THREAD SIZE	METRIC EQ	STRAIGHT THRU	SHUTOFF	A	B
 IN-LINE PIPE THREAD	3/8" NPT		HFC10635	HFCD10635	1.44 (36.6)	2.73 (69.3)
	3/8" BSPT		HFC10635BSPT	HFCD10635BSPT	1.44 (36.6)	2.73 (69.3)
	1/2" NPT		HFC10835	HFCD10835	1.44 (36.6)	2.88 (73.2)
	1/2" BSPT		HFC10835BSPT	HFCD10835BSPT	1.44 (36.6)	2.88 (73.2)
	3/4" NPT		HFC101235	HFCD101235	1.44 (36.6)	3.12 (79.2)
	3/4" BSPT		HFC101235BSPT	HFCD101235BSPT	1.44 (36.6)	3.12 (79.2)
 IN-LINE PIPE THREAD (FEMALE)	3/4" GHT		HFC191235GHT	HFCD191235GHT	1.44 (36.6)	2.70 (68.6)
	3/4" BSPP		HFC191235BSPP	HFCD191235BSPP	1.44 (36.6)	2.70 (68.6)
 BULKHEAD PANEL MOUNT HOSE BARB	3/8" ID	9.5mm ID	HFC16635	HFCD16635	1.44 (36.6)	2.82 (71.6)
	1/2" ID	12.7mm ID	HFC16835	HFCD16835	1.44 (36.6)	2.82 (71.6)
	5/8" ID	15.9mm ID	HFC161035	HFCD161035	1.44 (36.6)	2.94 (74.7)
	3/4" ID	19.0mm ID		HFCD161235	1.44 (36.6)	2.94 (74.7)
 IN-LINE HOSE BARB	3/8" ID	9.5mm ID	HFC17635	HFCD17635	1.44 (36.6)	2.82 (71.6)
	1/2" ID	12.7mm ID	HFC17835	HFCD17835	1.44 (36.6)	2.82 (71.6)
	5/8" ID	15.9mm ID	HFC171035	HFCD171035	1.44 (36.6)	2.94 (74.7)
	3/4" ID	19.0mm ID	HFC171235	HFCD171235	1.44 (36.6)	2.94 (74.7)

COUPLING INSERTS - Polysulfone

TERMINATION	TUBING/THREAD SIZE	METRIC EQ	STRAIGHT THRU	SHUTOFF	A	B	D
 IN-LINE PIPE THREAD (NON-VALVED SHOWN)	3/8" NPT		HFC24635	HFCD24635	1.16 (29.5)	1.82/1.94 (46.2/49.3)	
	3/8" BSPT		HFC24635BSPT	HFCD24635BSPT	1.16 (29.5)	1.97/2.09 (50.0/53.1)	
	1/2" NPT		HFC24835	HFCD24835	1.16 (29.5)	1.97/2.09 (50.0/53.1)	
	1/2" BSPT		HFC24835BSPT	HFCD24835BSPT	1.16 (29.5)	1.17/2.09 (29.7/53.1)	
	3/4" NPT		HFC241235	HFCD241235	1.23 (31.2)	2.22/2.34 (56.4/59.4)	
	3/4" BSPT		HFC241235GHT	HFCD241235BSPT	1.23 (31.2)	2.21/2.33 (56.1/59.2)	
	3/4" GHT		HFC241235GHT	HFCD241235GHT	1.23 (31.2)	2.03/2.15 (51.6/54.6)	
	 IN-LINE PIPE THREAD (FEMALE) (NON-VALVED SHOWN)	3/4" GHT		HFC261235GHT	HFCD261235GHT	1.37 (34.8)	1.79/1.91 (45.5/48.5)
3/4" BSPP			HFC261235BSPP	HFCD261235BSPP	1.37 (34.8)	1.79/1.91 (45.5/48.5)	
 IN-LINE HOSE BARB (NON-VALVED SHOWN)	3/8" ID	9.5mm ID	HFC22635	HFCD22635	1 (25.4)	1.91/2.03 (48.5/51.6)	
	1/2" ID	12.7mm ID	HFC22835	HFCD22835	1 (25.4)	1.91/2.03 (48.5/51.6)	
	5/8" ID	15.9mm ID	HFC221035	HFCD221035	1 (25.4)	2.03/2.15 (51.6/54.6)	
	3/4" ID	19.0mm ID	HFC221235	HFCD221235	1 (25.4)	2.03/2.15 (51.6/54.6)	
 ELBOW HOSE BARB (NON-VALVED SHOWN)	3/8" ID	9.5mm ID	HFC23635	HFCD23635	1 (25.4)	1.92/2.04 (48.8/51.8)	0.93 (23.6)
	1/2" ID	12.7mm ID	HFC23835	HFCD23835	1 (25.4)	1.96/2.08 (49.8/52.8)	0.93 (23.6)





All measurements are in inches (millimeters) unless otherwise noted. Tubing must meet stated inside and outside diameters.

HFC35 & HFC57 ACCESSORIES



DESCRIPTION	MATERIAL	PART NO.
PANEL MOUNT GASKET REPLACEMENT: FOR SEALING PANEL MOUNT BODIES LISTED ABOVE	EPDM	621200
GHT GASKET REPLACEMENT: FOR SEALING FEMALE THREADS	FDA EPDM	2339400

HFC57 SERIES DIMENSIONS

COUPLING BODIES - UV Polysulfone

TERMINATION	TUBING/THREAD SIZE	METRIC EQ	STRAIGHT THRU	SHUTOFF	A	B
 IN-LINE PIPE THREAD	3/8" BSPT			HFCD10657BSPT	1.44 (36.6)	2.73 (69.3)
	1/2" NPT		HFC10857	HFCD10857	1.44 (36.6)	2.88 (73.2)
	1/2" BSPT			HFCD10857BSPT	1.44 (36.6)	2.88 (73.2)
	3/4" BSPT			HFCD101257GHT	1.44 (36.6)	3.12 (79.2)
	3/4" GHT			HFC101257GHT	1.44 (36.6)	2.94 (74.7)
 IN-LINE PIPE THREAD (FEMALE)	3/4" GHT		HFC191257GHT	HFCD191257GHT	1.44 (36.6)	2.70 (68.6)
 BULKHEAD PANEL MOUNT HOSE BARB	3/8" ID	9.5mm ID		HFCD16657	1.82 (46.2)	2.82 (71.6)
	1/2" ID	12.7mm ID		HFCD16857	1.82 (46.2)	2.82 (71.6)
	5/8" ID	15.9mm ID		HFCD161057	1.82 (46.2)	2.94 (74.7)
	3/4" ID	19.0mm ID		HFCD161257	1.82 (46.2)	2.94 (74.7)
 IN-LINE HOSE BARB	3/8" ID	9.5mm ID	HFC17657	HFCD17657	1.44 (36.6)	2.82 (71.6)
	1/2" ID	12.7mm ID	HFC17857	HFCD17857	1.44 (36.6)	2.82 (71.6)
	5/8" ID	15.9mm ID		HFCD171057	1.44 (36.6)	2.94 (74.7)
	3/4" ID	19.0mm ID		HFC171257	HFCD171257	1.44 (36.6)

COUPLING INSERTS - UV Polysulfone

TERMINATION	TUBING/THREAD SIZE	METRIC EQ	STRAIGHT THRU	SHUTOFF	A	B
 IN-LINE PIPE THREAD	3/8" BSPT	HFCD24657BSPT	HFC24657BSPT	HFCD24857	1.16 (29.5)	1.84/1.96 (46.7/49.8)
	1/2" BSPT	HFCD24857BSPT	HFC24857BSPT	HFCD241257BSPT	1.16 (29.5)	1.99/2.07 (50.6/52.6)
	1/2" NPT	HFCD24857	HFC24857	HFCD241257GHT	1.16 (29.5)	1.95/2.11 (49.5/53.6)
	3/4" BSPT	HFCD241257BSPT			1.23 (31.2)	2.19/2.31 (55.6/58.7)
	3/4" GHT	HFCD241257GHT	HFC241257GHT		1.16 (29.5)	2.15/2.27 (54.6/57.7)
 IN-LINE PIPE THREAD (FEMALE) (NON-VALVED SHOWN)	3/4" GHT		HFC261257GHT	HFCD261257GHT	1.37 (34.8)	1.79/1.91 (45.5/48.5)
 IN-LINE HOSE BARB (NON-VALVED SHOWN)	3/8" ID	9.5mm ID	HFC22657	HFCD22657	1 (25.4)	1.91/2.03 (48.5/51.6)
	1/2" ID	12.7mm ID	HFC22857	HFCD22857	1 (25.4)	1.91/2.03 (48.5/51.6)
	5/8" ID	15.9mm ID		HFCD221057	1 (25.4)	2.03/2.15 (51.6/54.6)
	3/4" ID	19.0mm ID		HFC221257	HFCD221257	1 (25.4)

All measurements are in inches (millimeters) unless otherwise noted. Tubing must meet stated inside and outside diameters. Couplings are pictured with valves unless otherwise noted.

PRODUCT DIMENSIONS

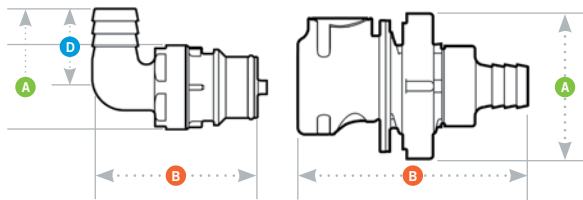

- A = Height/Diameter
- B = Total Length
- D = Elbow Radial Length

PANEL DIMENSIONS

	PANEL OPENING	PANEL THICKNESS MAX.-MIN.
COUPLING BODIES	see drawing	0.25-0.03

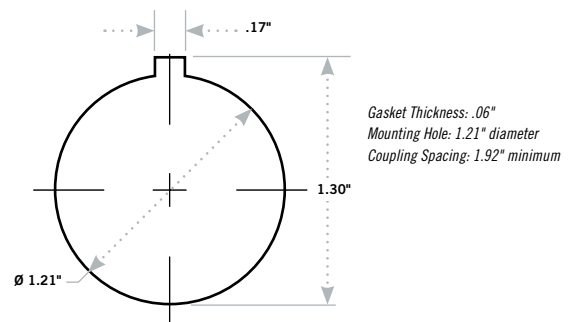

FFC35 SERIES CONNECTOR

FFC35 Series 1/2" flow couplings feature double the flow of the HFC Series couplings. The FFC Series has a non-valved bore that increases flow and minimizes turbulence. The polysulfone material is able to withstand demanding applications and features physical strength, chemical resistance and autoclavability. An ergonomic design and a large, shrouded thumb latch pad produce a coupling that is easy to grip and simple to operate.



SPECIFICATIONS

PRESSURE:

Vacuum to 125 psi, 8.6 bar

TEMPERATURE:

-40°F to 280°F (-40°C to 138°C)

MATERIALS:

Main components: Polysulfone

Thumb latch: Polysulfone

External spring: 316 stainless steel

O-rings: FDA Buna-N

Panel mount gasket: EPDM

Female GHT gasket: FDA EPDM

COLOR:

Natural white with dark gray latch

TUBING SIZES: 3/4" ID, 19.0mm ID

WARNING: Pressure, temperature, chemicals, and operating environment can affect the performance of couplings. It is the customer's responsibility to test the suitability of CPC products in their own application conditions. Use the graphs on the following page as a guide.



cpcworldwide.com/FFC35

FEATURES

No valves



BENEFITS

Exceptional flow

Polysulfone material



Physically strong and autoclavable

Ergonomic design



Easy to grip, simple to operate

FPC WATER FLOW

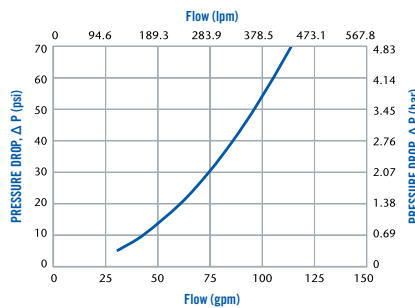

FCC AIR FLOW • 100 psig inlet pressure

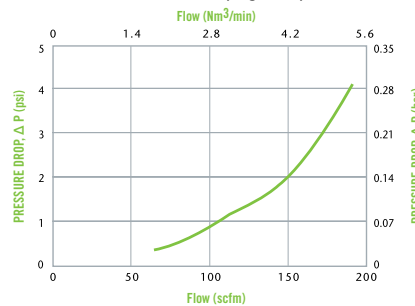

These graphs are intended to give you a general idea of the performance capabilities of each product line. The shaded area of each graph represents the operating range of the product family, i.e., upper and lower values are shown. Therefore, depending on the exact coupling configurations selected, you can reasonably expect values to fall within the shaded area.





NON-VALVED

CPC's FFC35 Series couplings feature a wide open, straight-thru flow path.





FFC35 SERIES DIMENSIONS

COUPLING BODIES - Polypropylene

TERMINATION	TUBING/THREAD SIZE	METRIC EQ.	STRAIGHT THRU	A	B
 IN-LINE PIPE THREAD	1/2" NPT		FFC10835	1.44 (35.3)	2.88 (70.6)
	1/2" BSPT		FFC10835BSPT	1.44 (35.3)	2.88 (70.6)
	3/4" NPT		FFC101235	1.44 (35.3)	3.12 (76.4)
	3/4" GHT		FFC101235GHT	1.44 (35.3)	2.94 (72.0)
 IN-LINE PIPE THREAD (FEMALE)	3/4" BSPP		FFC191235BSPP	1.44 (35.3)	2.7 (66.2)
 BULKHEAD PANEL MOUNT HOSE BARB	3/4" ID	19.0mm ID	FFC161235	1.44 (35.3)	2.94 (72.0)
 IN-LINE HOSE BARB	3/4" ID	19.0mm ID	FFC171235	1.44 (35.3)	2.94 (72.0)

COUPLING INSERTS - Polypropylene

TERMINATION	TUBING/THREAD SIZE	METRIC EQ.	STRAIGHT THRU	A	B
 IN-LINE PIPE THREAD	1/2" NPT		FFC24835	1.16 (28.4)	1.95 (47.8)
	1/2" BSPT		FFC24835BSPT	1.16 (28.4)	1.95 (47.8)
	3/4" NPT		FFC241235	1.23 (30.1)	2.14 (52.4)
	3/4" BSPT		FFC241235BSPT	1.23 (30.1)	2.14 (52.4)
 IN-LINE PIPE THREAD (FEMALE)	3/4" BSPP		FFC261235BSPP	1.37 (33.6)	1.77 (43.4)
 IN-LINE HOSE BARB	3/4" ID	19.0mm ID	FFC221235	1 (24.5)	2.02 (49.5)

All measurements are in inches (millimeters) unless otherwise noted. Tubing must meet stated inside and outside diameters. Couplings are pictured with valves unless otherwise noted.

ACCESSORIES

DESCRIPTION	MATERIAL	PART NO.
PANEL MOUNT GASKET REPLACEMENT: FOR SEALING FEMALE THREADS	EPDM	621200
GHT GASKET REPLACEMENT: FOR SEALING FEMALE THREADS	FDA EPDM	2339400

PRODUCT DIMENSIONS

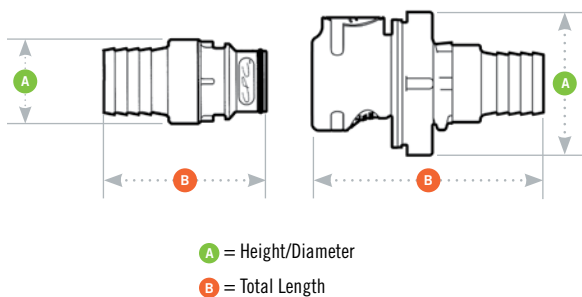

PANEL DIMENSIONS

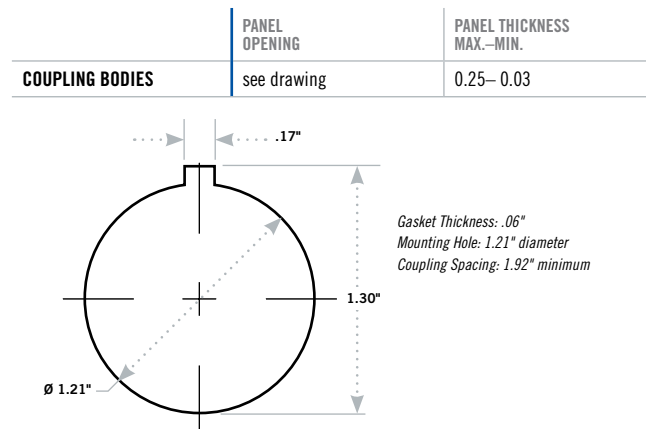



Enhance design flexibility and prevent misconnections with a single point of connection for multiple flow paths

CPC multi-line connectors and couplings reduce system complexity by streamlining the user interface with one easy-to-use connection. Connecting multiple flow paths, including dissimilar fluids or gases, into a single, integrated coupling speeds device setup, reduces misconnections and enhances equipment usability. Select from a broad range of CPC multi-line couplings including:

- Options for two to ten different lines to meet specific application needs
- Variety of flow sizes, terminations and materials for increased design flexibility
- Selections for mounting couplings to a panel that connect to 3-5 lines simultaneously for easier equipment integration
- Tubing orientation is ensured by keying the coupling body and insert

Choose multi-line couplings and connectors to reduce system components and increase design flexibility. If you have multiple flow paths, CPC multi-line couplings and connectors bring them together for a simplified user interface.

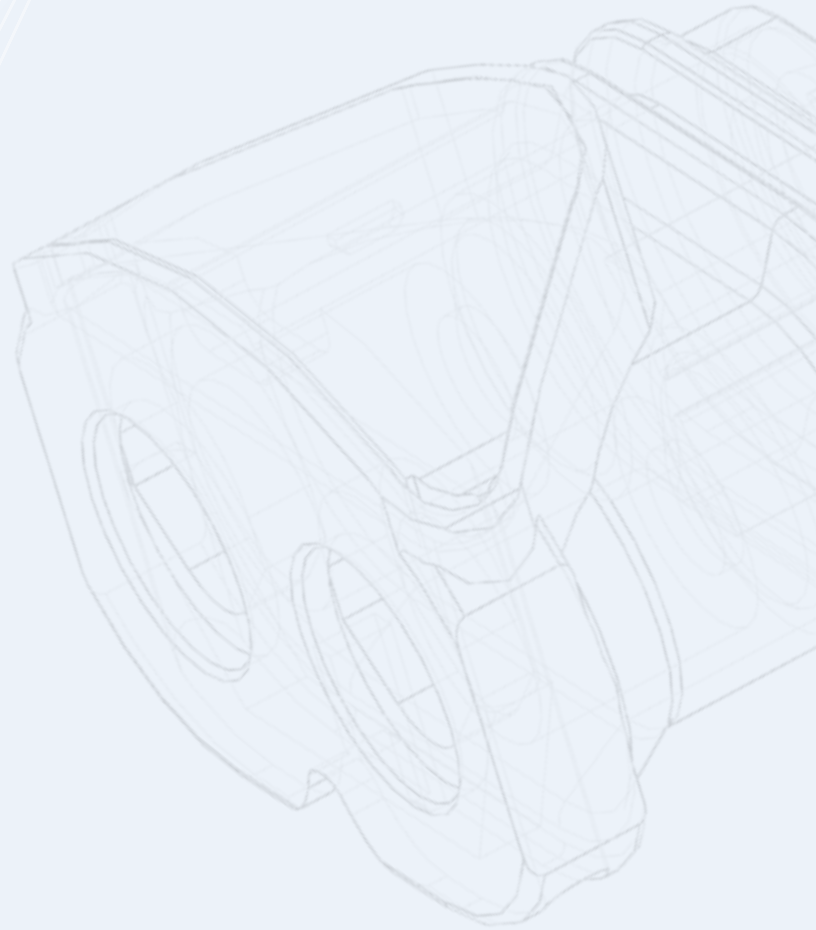

MULTI-LINE
Couplings and Connectors

TENTUBE SERIES CONNECTOR

The Tentube™ coupling provides one easy-to-use quick disconnect for up to ten separate fluid lines. The Tentube is available with valves on the body side in panel mount or in-line configurations for maximum design flexibility. The Tentube can connect and disconnect up to ten lines with the use of a simple slide latch. Tubing orientation is ensured by keying the coupling body and insert. Different fluids and tubing sizes can be accommodated by using acetal or polypropylene inserts in three popular sizes.

SPECIFICATIONS

PRESSURE:

Vacuum to 100 psi, 6.9 bar per line

TEMPERATURE:

Acetal fitting inserts:

-40°F to 180°F (-40°C to 82°C)

Polypropylene fitting inserts:

32°F to 180°F (0°C to 82°C)

MATERIALS:

Main components: Nylon

Valves: Acetal

Valve springs: 316 stainless steel

Fitting inserts: Acetal or polypropylene

O-rings: Buna-N with acetal

or EPDM with polypropylene

Panel mount adapter: Acetal

Tube shroud: Acetal

COLOR:

Main components:

Black with red locking latch

Tube shroud: Black

Panel mount adapter: Black

TUBING SIZES:

1/16" to 1/8" ID, 1.6mm to 3.2mm ID



cpcworldwide.com/Tentube



CONNECT UP TO 10 TUBES
IN ONE EASY MOTION!

FEATURES

Ten line connection



BENEFITS

Fast, efficient operation

Separate flow paths



Pressure and/or vacuum in one coupling

Insert is keyed to body



Ensures correct line orientation

Acetal or polypropylene inserts



Maximize design flexibility

NOTE

Use TMF and TFF inserts and bodies for custom designed assemblies.

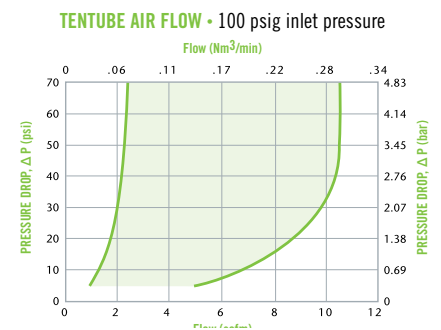
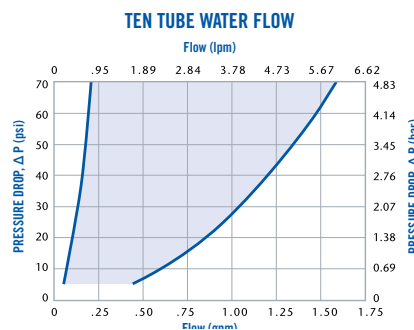

These graphs are intended to give you a general idea of the performance capabilities of each product line. The shaded area of each graph represents the operating range of the product family, i.e., upper and lower values are shown. Therefore, depending on the exact coupling configurations selected, you can reasonably expect values to fall within the shaded area.

TENTUBE SERIES DIMENSIONS

FITTING BODIES - Acetal/Polypropylene



TERMINATION	TUBING/THREAD SIZE	METRIC EQ.	ACETAL STRAIGHT THRU	ACETAL SHUTOFF	POLYPROPYLENE STRAIGHT THRU
COMPLETE COUPLING SET	1/16" ID	1.6mm ID	TT1001	TTD1001	
	–	3.0mm ID	TT10M3	TTD10M3	
	1/8" ID	3.2mm ID	TT1002	TTD1002	TT100212
COUPLING BODY WITH FEMALE FITTING BODIES	1/16" ID	1.6mm ID	TFB1001	TFBD1001	
	–	3.0mm ID	TFB10M3		
	1/8" ID	3.2mm ID	TFB1002	TFBD1002	TFB100212
	Without fitting bodies		TFB10		
COUPLING INSERT WITH MALE FITTING INSERTS	1/16" ID	1.6mm ID	TMB1001		
	–	3.0mm ID	TMB10M3		
	1/8" ID	3.2mm ID	TMB1002		TMB100212
	Without fitting inserts		TMB10		

FITINGS INSERTS - Acetal/Polypropylene



TERMINATION	TUBING/THREAD SIZE	METRIC EQ.	ACETAL STRAIGHT THRU	ACETAL SHUTOFF	POLYPROPYLENE STRAIGHT THRU
IN-LINE HOSE BARB	1/16" ID	1.6mm ID	TMF01		TMF0112
	–	3.0mm ID	TMFM3		
	1/8" ID	3.2mm ID	TMF02		TMF0212
IN-LINE HOSE BARB (FEMALE)	1/16" ID	1.6mm ID	TFF01	TFFD01	TFF0112
	–	3.0mm ID	TFFM3	TFFDM3	
	1/8" ID	3.2mm ID	TFF02	TFFD02	TFF0212
IN-LINE HOSE BARB (FEMALE) (WHITE)	1/8" ID	3.2mm ID	TFF02MWHT	TFFD02MWHT	
IN-LINE HOSE BARB (WHITE)	1/8" ID	3.2mm ID	TMF02MWHT		

Note: Acetal bodies and inserts are also available in white. To order, add MWHT to the end of the part number. All measurements are in inches (millimeters) unless otherwise noted. Tubing must meet stated inside and outside diameters. Couplings are pictured with valves unless otherwise noted.

ACCESSORIES

DESCRIPTION	PART NO.
TUBE SHROUD: SNAPS INTO EITHER HALF	TS10
PANEL MOUNT ADAPTER & NUT: 7/16" MAX. PANEL THICKNESS; REQUIRES 1.875" DIAMETER HOLE	TPM10

PANEL DIMENSIONS

	PANEL OPENING	PANEL THICKNESS MAX.-MIN.
COUPLING BODIES	see drawing	0.44–0.06

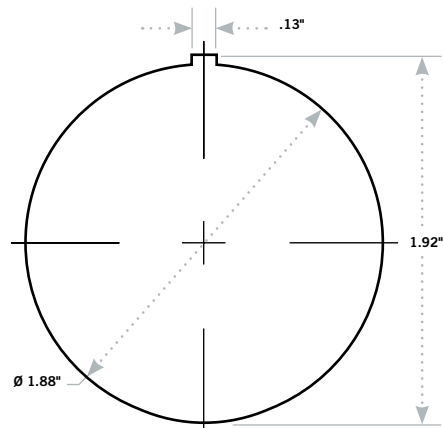

TWIN TUBE™ & SIXTUBE™ SERIES CONNECTOR

The Twin Tube™ coupling

provides one easy-to-use quick disconnect for two separate fluid lines. The non-valved Twin Tube maintains two individual flow paths in one coupling. Featuring the CPC thumb latch, the Twin Tube can disconnect two lines with the push of a button. The panel mount design keeps a low profile on the front of the equipment panel.

SPECIFICATIONS

PRESSURE:

Vacuum to 120 psi, 8.3 bar per line

TEMPERATURE:

-40°F to 180°F (-40°C to 82°C)

MATERIALS:

Main components: Acetal, ABS

Thumb latch: Stainless steel

External springs and pin: Stainless steel

O-rings: Buna-N

COLOR:

Natural white with stainless steel latch

TUBING SIZES:

1/16" to 1/8" ID, 1.6mm to 3.2mm ID

The SixTube™ coupling

provides one easy-to-use quick disconnect for up to six separate fluid lines. The Sixtube is available with valves on either side for maximum design flexibility. Featuring the CPC thumb latch, the Sixtube can disconnect up to six lines with the push of a button. The snap-in panel mount design keeps a low profile on the front of the equipment panel.

SPECIFICATIONS

PRESSURE:

Vacuum to 100 psi, 6.9 bar per line

TEMPERATURE:

Acetal fitting inserts:
-40°F to 180°F (-40°C to 82°C)

Polypropylene fitting inserts:
32°F to 180°F (0°C to 82°C)

MATERIALS:

Main components: Acetal

Valves: Acetal

Fitting inserts: Acetal, polypropylene

Thumb latch: Acetal

Valve spring: 316 stainless steel

O-rings: Buna-N with acetal or EPDM with polypropylene

COLOR: Natural white with aqua latch

TUBING SIZES:

1/16" to 1/8" ID, 1.6mm to 3.2mm ID

FEATURES

- Two/six line connection → Fast, efficient operation
- Separate flow paths → Pressure and/or vacuum in one coupling
- Sixtube insert is keyed to body → Ensures correct line orientation
- Free coupling rotation (Twin Tube) → Eliminates kinked tubing
- CPC thumb latch → One-hand connection and disconnection

BENEFITS

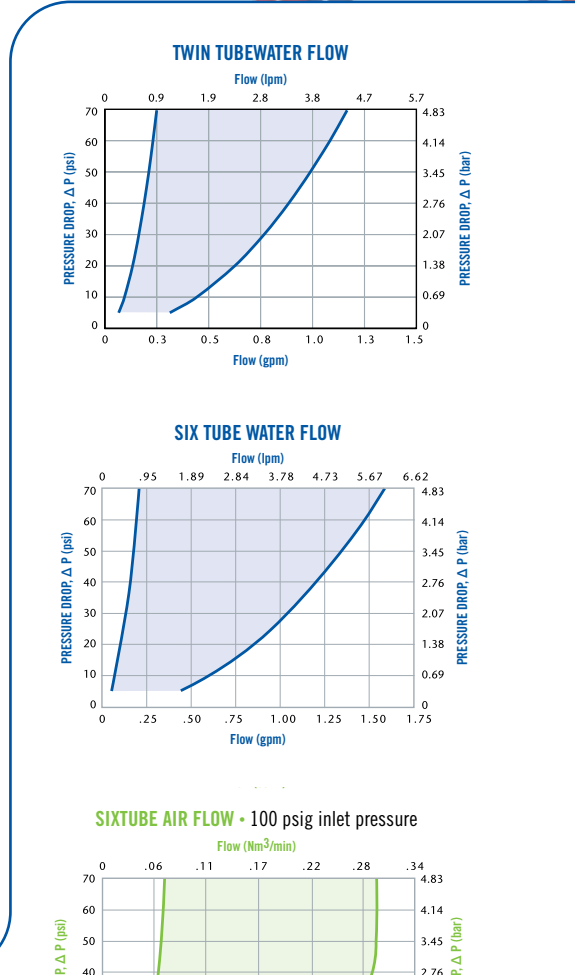

These graphs are intended to give you a general idea of the performance capabilities of each product line. The shaded area of each graph represents the operating range of the product family, i.e., upper and lower values are shown. Therefore, depending on the exact coupling configurations selected, you can reasonably expect values to fall within the shaded area.



TWIN TUBE™ & SIXTUBE™ SERIES DIMENSIONS

TWIN TUBE COUPLING BODIES - Acetal/ABS



ABS part shown

TERMINATION	TUBING/THREAD SIZE	METRIC EQ.	ACETAL STRAIGHT THRU	ABS STRAIGHT THRU
PANEL MOUNT HOSE BARB	1/16" ID	1.6mm ID	PTC16010	PTC1602096
	1/8" ID	3.2mm ID	PTC16020	

TWIN TUBE COUPLING INSERTS - Acetal/ABS



Acetal part shown

TERMINATION	TUBING/THREAD SIZE	METRIC EQ.	ACETAL STRAIGHT THRU	ABS STRAIGHT THRU
IN-LINE HOSE BARB	1/16" ID	1.6mm ID	PTC22010	
	1/8" ID	3.2mm ID	PTC22020	PTC2202096

SIXTUBE COUPLING BODIES - Acetal/Polypropylene



Acetal part shown

TERMINATION	TUBING/THREAD SIZE	METRIC EQ.	ACETAL STRAIGHT THRU	ABS SHUTOFF	POLYPROPYLENE STRAIGHT THRU
IN-LINE HOSE BARB	1/16" ID	1.6mm ID	SXM1701		SXM170112
	-	3.0mm ID	SXM17M3		
	1/8" ID	3.2mm ID	SXM1702		SXM170212
WITH FEMALE FITTING BODIES	1/16" ID	1.6mm ID		SXFD1701	SXF170112
	1/8" ID	3.2mm ID	SXF1702	SXFD1702	SXF170212
WITHOUT FITTINGS			SX17		

SIXTUBE COUPLING INSERTS - Acetal/Polypropylene



Acetal part shown

TERMINATION	TUBING/THREAD SIZE	METRIC EQ.	ACETAL STRAIGHT THRU	ABS SHUTOFF	POLYPROPYLENE STRAIGHT THRU
IN-LINE HOSE BARB	1/16" ID	1.6mm ID	SXM4201		SXM420112
	-	3.0mm ID	SXM42M3		
	1/8" ID	3.2mm ID	SXM4202		SXM420212
	1/16" ID	1.6mm ID	SXF4201	SXFD4201	SXF420112
	-	3.0mm ID	SXF42M3	SXFD42M3	
	1/8" ID	3.2mm ID	SXF4202	SXFD4202	SXF420212

ACCESSORIES

DESCRIPTION	PART NO.
SIXTUBE PRESSURE PLUGS	TMPMWHT



SCAN

cpcworldwide.com/TwinTube



SCAN

cpcworldwide.com/Sixtube

TWIN TUBE™ PANEL DIMENSIONS

	PANEL NUT HEX	PANEL NUT THREAD
COUPLING INSERTS	13/16	11/16-24UNEF

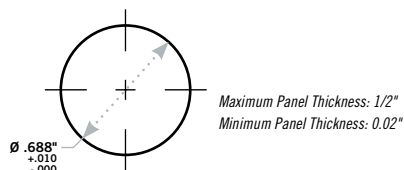

SIXTUBE™ PANEL DIMENSIONS

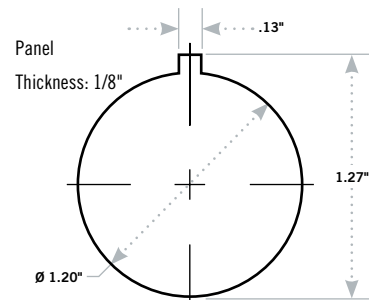

MULTI-MOUNT SERIES CONNECTOR

Multi-Mount couplings provide one easy-to-use coupling for connecting from three to five lines at once. Multi-mount couplings are available in a wide variety of materials including acetal and chrome-plated brass. Multi-mounts are keyed to prevent mismatched connections and can be configured with or without valves for maximum design flexibility.

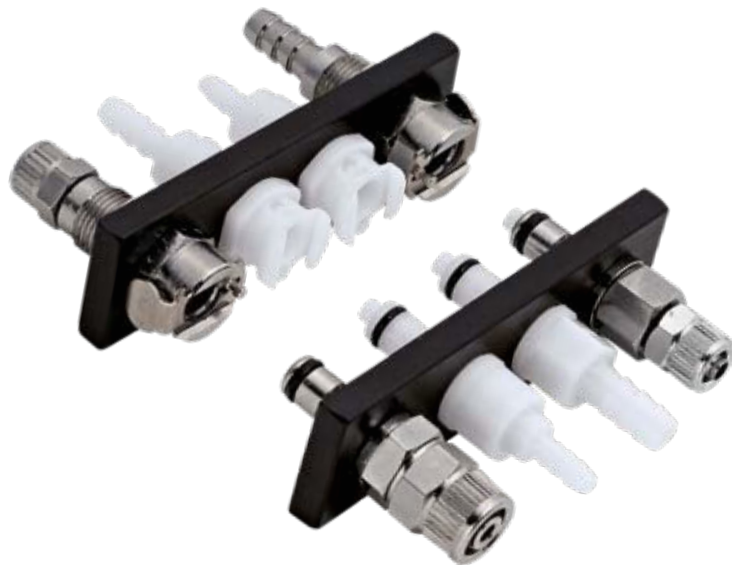

SPECIFICATIONS

PRESSURE:

Minimum: Vacuum

Maximum: Brass = 500 psi / no. of stations
or Acetal = 240 psi / no. of stations

TEMPERATURE:

-40°F to 180°F (-40°C to 82°C)

MATERIALS:

Main components: Acetal or chrome-plated brass

Thumb latch: Stainless steel

Mounting Plate: Black anodized aluminum

Valves: Acetal

Valve spring: 316 stainless steel

External springs and pin: Stainless steel

O-ring: Buna-N

TUBING SIZES:

1/8" to 3/8" ID, 3.2mm to 9.5mm ID

FEATURES

Three to five line connection



BENEFITS

Fast, efficient operation

Separate flow paths



Pressure and/or vacuum in one coupling

Insert is keyed to body



Ensures correct line orientation

Acetal or chrome-plated brass



Maximize design flexibility

FOUR-STEP MULTI-MOUNT ORDERING PROCESS

STEP 1: Determine flow size and termination type.

STEP 2: Order two "multiple mount plates" (one for the coupling bodies and one for the coupling inserts) with the appropriate number of connection stations for your specific application (available in 3, 4, or 5 connections, or construct your own). Refer to page 108-109.

STEP 3: Order two "standard panel mount coupling bodies with thumb latches" for the exterior stations.

STEP 4: Order an appropriate number of "multiple mount coupling bodies without thumb latches" to accommodate the remaining interior stations.

STEP 5: Order an appropriate number of "multiple mount inserts" to connect with standard and multiple mount bodies.



cpcworldwide.com/Multi-mount

STEP 3

Multiple mount coupling bodies for interior stations

STEP 2

Standard panel mount coupling bodies with thumb latch for exterior stations

STEP 1

Multiple mount plates

STEP 4

Multiple mount coupling inserts

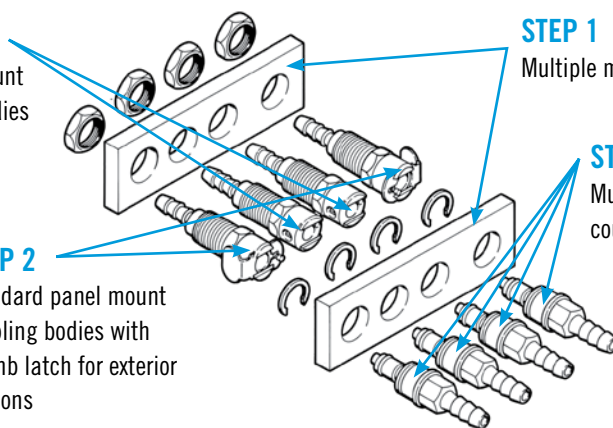

UNMATCHED CUSTOMIZATION CAPABILITIES



For more than 35 years, CPC engineers have worked with customers worldwide to design application-specific solutions that resolve their fluid handling-related challenges and improve product performance. We can do the same for you.

APPLICATIONS FOR IDENTIQUIK® COUPLINGS INCLUDE:

- Weight, pressure, temperature and flow sensing
- Bulkhead mount readers
- Multiplexing technology
- Custom interface
- Larger tag memory sizes
- Additional security features



cpcworldwide.com/iMAR

MULTI-MOUNT SERIES DIMENSIONS

MULTIPLE MOUNT PLATES





NUMBER OF STATIONS	1/8" FLOW SIZE	LENGTH	1/4" FLOW SIZE	LENGTH
3	CP103	2.6 (66.04)	LCP103	3 (76.2)
4	CP104	3.35 (85.09)	LCP104	3.35 (85.09)
5	CP105	4.1 (104.14)	LCP105	4.9 (124.46)

RETAINING RINGS



COUPLING SERIES	PART NO. (REPLACEMENTS)
MC/PMC	101700
LC/PLC	278100

COUPLING BODIES - Acetal

Information in RED indicates 1/8" flow couplings. These are not compatible with 1/4" flow couplings in non-shaded sections.

TERMINATION	TUBING/THREAD SIZE	METRIC EQ.	STRAIGHT THRU	SHUTOFF	A	B	D
 PANEL MOUNT FERRULELESS POLYTUBE FITTING, PTF†	1/4" OD, 0.17" ID	6.4mm OD, 4.3mm ID	PMM1204	PMMD1204	0.72 (18.3)	1.72 (43.7)	
	1/4" OD, 0.17" ID	6.4mm OD, 4.3mm ID	PLM12004	PLMD12004	0.94 (23.9)	1.82 (46.2)	
	3/8" OD, 0.25" ID	9.5mm OD, 6.4mm ID		PLMD12006	0.94 (23.9)	1.95 (49.5)	
 PANEL MOUNT HOSE BARB	1/8" ID	3.2mm ID	PMM1602	PMMD1602	0.72 (18.3)	1.65 (41.9)	
	3/16" ID	4.8mm ID	PMM1603	PMMD1603	0.72 (18.3)	1.85 (47.0)	
	1/4" ID	6.4mm ID	PMM1604	PMMD1604	0.72 (18.3)	1.85 (47.0)	
	1/4" ID	6.4mm ID	PLM16004	PLMD16004	0.94 (23.9)	1.95 (49.5)	
	5/16" ID	7.9mm ID	PLM16005	PLMD16005	0.94 (23.9)	1.95 (49.5)	
	3/8" ID	9.5mm ID		PLMD16006	0.94 (23.9)	1.95 (49.5)	
 PANEL MOUNT FEMALE THREAD	10-32 UNF		PMM181032	PMMD181032	0.72 (18.3)	1.25 (31.8)	



COUPLING INSERTS - Acetal

TERMINATION	TUBING/THREAD SIZE	METRIC EQ.	STRAIGHT THRU	SHUTOFF	A	B	D
 IN-LINE FERRULELESS POLYTUBE FITTING, PTF†	5/32" OD, 0.10" ID	4.0mm OD, 2.5mm ID	PMM20025	PMMD20025	0.58 (14.7)	1.86/1.96 (47.2/49.8)	
	1/4" OD, 0.17" ID	6.4mm OD, 4.3mm ID	PMM2004	PMMD2004	0.58 (14.7)	1.77/1.87 (45.0/47.5)	
	1/4" OD, 0.17" ID	6.4mm OD, 4.3mm ID	PLM20004	PLMD20004	0.72 (18.3)	2.10/2.23 (53.3/56.6)	
	3/8" OD, 0.25" ID	9.5mm OD, 6.4mm ID		PLMD20006	0.72 (18.3)	2.02/2.15 (51.3/54.6)	
 IN-LINE HOSE BARB	1/8" ID	3.2mm ID	PMM2202	PMMD2202	0.56 (14.2)	1.87/1.97 (47.5/50.0)	
	3/16" ID	4.8mm ID	PMM2203	PMMD2203	0.58 (14.7)	2.08/2.18 (52.8/55.4)	
	1/4" ID	6.4mm ID	PMM2204	PMMD2204	0.58 (14.7)	1.83/1.93 (46.5/49.0)	
	1/4" ID	6.4mm ID	PLM22004	PLMD22004	0.72 (18.3)	2.20/2.33 (55.9/59.2)	
	5/16" ID	7.9mm ID	PLM22005	PLMD22005	0.72 (18.3)	2.20/2.33 (55.9/59.2)	
	3/8" ID	9.5mm ID	PLM22006	PLMD22006	0.72 (18.3)	2.03/2.16 (51.6/54.9)	
 ELBOW FERRULELESS POLYTUBE FITTING, PTF†	1/4" OD, 0.17" ID	6.4mm OD, 4.3mm ID	PMM2104	PMMD2 104	0.53 (13.5)	1.41/1.51 (35.8/38.4)	0.77 (19.6)

All measurements are in inches (millimeters) unless otherwise noted. Tubing must meet stated inside and outside diameters. Couplings are pictured with valves unless otherwise noted.

†NOTE: CPC's Ferruleless Polytube Fitting terminations do not require ferrules to achieve a secure connection, which makes them easier to use and reuse. PTF fittings are designed for semi-rigid tubing, i.e., polyethylene, nylon, polyurethane, etc.

COUPLING BODIES - Chrome Plated Brass

TERMINATION	TUBING/THREAD SIZE	METRIC EQ.	STRAIGHT THRU	SHUTOFF	A	B	D
 PANEL MOUNT FERRULELESS POLYTUBE FITTING, PTF†	1/4" OD, 0.17" ID	6.4mm OD, 4.3mm ID	MM1204	MMD1204	0.72 (18.3)	1.72 (43.7)	
	1/4" OD, 0.17" ID	6.4mm OD, 4.3mm ID		LMD12004	0.94 (23.9)	1.82 (46.2)	
	3/8" OD, 0.25" ID	9.5mm OD, 6.4mm ID	LM12006	LMD12006	0.94 (23.9)	1.95 (49.5)	
 PANEL MOUNT HOSE BARB	1/8" ID	3.2mm ID	MM1602	MMD1602	0.72 (18.3)	1.65 (41.9)	
	3/16" ID	4.8mm ID	MM1603	MMD1603	0.72 (18.3)	1.85 (47.0)	
	1/4" ID	6.4mm ID	LM16004	LMD16004	0.94 (23.9)	1.95 (49.5)	
	5/16" ID	7.9mm ID	LM16005	LMD16005	0.94 (23.9)	1.95 (49.5)	
	3/8" ID	9.5mm ID	LM16006	LMD16006	0.94 (23.9)	1.95 (49.5)	
 PANEL MOUNT FEMALE THREAD	10-32 UNF		MM181032		0.72 (18.3)	1.25 (31.8)	

COUPLING INSERTS - Chrome Plated Brass

TERMINATION	TUBING/THREAD SIZE	METRIC EQ.	STRAIGHT THRU	SHUTOFF	A	B	D
 IN-LINE FERRULELESS POLYTUBE FITTING, PTF†	5/32" OD, 0.10" ID	4.0mm OD, 2.5mm ID	MM20025	MMD20025	0.58 (14.7)	1.86/1.96 (47.2/49.8)	
	1/4" OD, 0.17" ID	6.4mm OD, 4.3mm ID	MM2004	MMD2004	0.58 (14.7)	1.77/1.87 (45.0/47.5)	
	1/4" OD, 0.17" ID	6.4mm OD, 4.3mm ID	LM20004	LMD20004	0.72 (18.3)	2.10/2.23 (53.3/56.6)	
	3/8" OD, 0.25" ID	9.5mm OD, 6.4mm ID	LM20006	LMD20006	0.72 (18.3)	2.02/2.15 (51.3/54.6)	
 IN-LINE HOSE BARB	1/8" ID	3.2mm ID	MM2202	MMD2202	0.56 (14.2)	1.87/1.97 (47.5/50.0)	
	3/16" ID	4.8mm ID	MM2203	MMD2203	0.58 (14.7)	2.08/2.18 (52.8/55.4)	
	1/4" ID	6.4mm ID	MM2204	MMD2204	0.58 (14.7)	1.83/1.93 (46.5/49.0)	
	1/4" ID	6.4mm ID	LM22004	LMD22004	0.72 (18.3)	2.20/2.33 (55.9/59.2)	
	5/16" ID	7.9mm ID	LM22005	LMD22005	0.72 (18.3)	2.20/2.33 (55.9/59.2)	
	3/8" ID	9.5mm ID	LM22006	LMD22006	0.72 (18.3)	2.03/2.16 (51.6/54.9)	
 ELBOW FERRULELESS POLYTUBE FITTING, PTF†	1/4" OD, 0.17" ID	6.4mm OD, 4.3mm ID	MM2104		0.53 (13.5)	1.41/1.51 (35.8/38.4)	0.77 (19.6)

PRODUCT DIMENSIONS

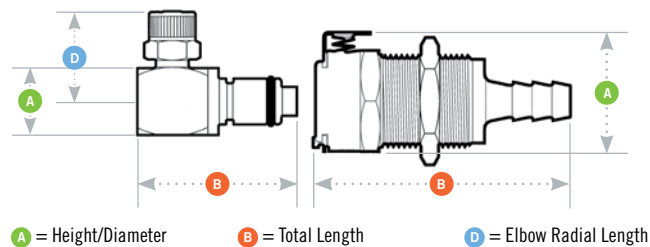

PANEL DIMENSIONS

MM Series 1/8" Flow

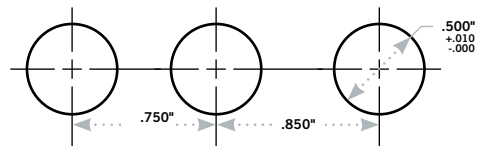

LM Series 1/4" Flow

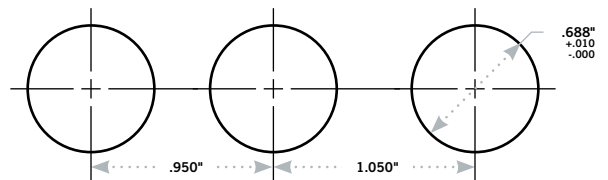

Multiple mount plates are keyed to prevent misconnections.

Multiple mount minimum coupling spacing: CPC offsets the last hole on the mounting plates so they cannot be misconnected.

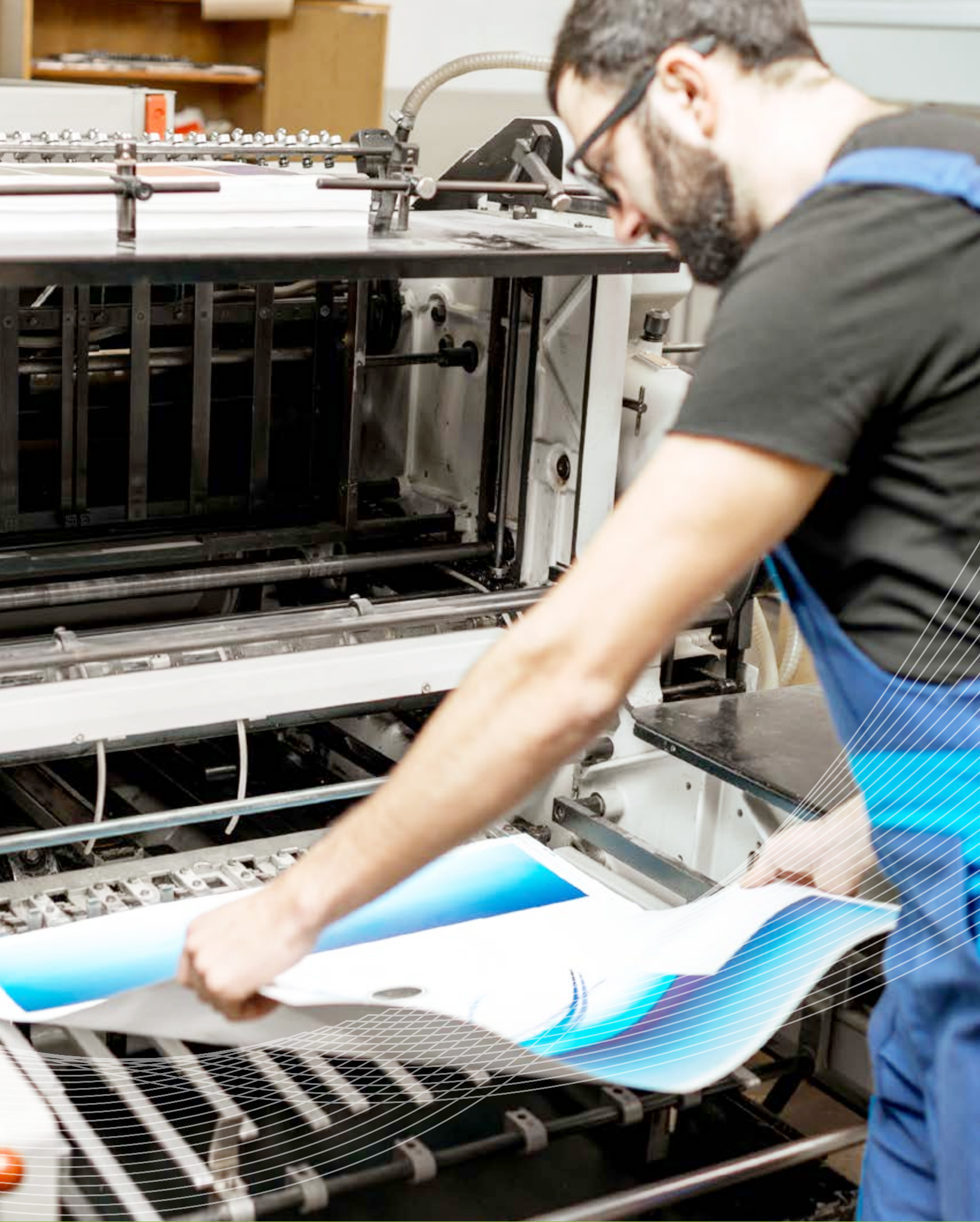

Redefine what's possible for controlling, protecting and streamlining fluid handling processes with connectors that do more.

CPC's innovative, enhanced functionality couplings and connectors integrate electronics or identification capabilities to streamline equipment safety and useability. Integrate air lines, electrical connections and fluid lines into a single, compact, hybrid connection point. Use RFID-enabled IdentiQuik® quick disconnect couplings to exchange rewritable data once the coupling halves come within a few centimeters of one another.

Tap the enhanced functionality of hybrid and RFID-enabled couplings and connectors to streamline the user interface by eliminating the potential for misconnecting tubing and wires. Additionally, these enhanced hybrid couplings reduce engineering development time with a single product to specify, test and validate while producing an overall streamlined equipment design. The RFID-intelligent IdentiQuik technology protects brand, prolongs equipment life and increases efficiency.

- Robust transfer of fluid and information in one connection
- Connection of power, signal and fluids in one simple motion
- Vast array of materials and configurations to fit application needs
- Hybrid connector features an easy-to-use twist latch for secure, repeatable connection of multiple lines
- Embedded RFID-based electronic intelligence into a variety of coupling configurations

Be more creative in equipment design with hybrid and RFID-enabled connectors that simplify user interfaces and improve equipment effectiveness.



ENHANCED FUNCTIONALITY
Couplings and Connectors

HYBRID SERIES CONNECTOR

Hybrid connectors integrate air lines, electrical connections and fluid lines into a single, compact connection point for remote tools on medical devices and equipment. Eliminating the potential for misconnecting tubing and wires, CPC's Hybrid Connector platform options reduce multiple connections and allow clinicians or patients to quickly and easily change or replace modular tools, umbilicals or hand pieces.

Large Format Hybrid Connector – Now available with four times the flow capacity, this connector features multiple dry-break couplings and easy-to-use twist latch for secure, repeatable connection of multiple lines.

SPECIFICATIONS

PRESSURE:

Vacuum to 45 psi, 3.1 bar

TEMPERATURE:

32°F to 120°F (0°C to 49°C)

MATERIALS:

Non-wetted coupler components:

Glass-filled polypropylene

Wetted coupler components: Glass-filled

polypropylene

Springs: Stainless steel

Electrical contacts: Gold-plated copper alloy

O-rings: EPDM

Fluid tubing: Polyurethane (PU)

Umbilical tubing: PVC

COLOR: Gray

TERMINATIONS:

Panel: Two 1/8" (3.2mm) hose barbs on panel and four 20 ga wires with 12" (304.3mm) pigtail

Umbilical Hose: 8' (2.44M) umbilical with two 1/8" (3.2mm) ID PU tubing and four 20ga wires with 3" (76.2mm) pigtail

NUMBER OF FLUID LINES: 2

ELECTRICAL SPECIFICATIONS

Voltage: Up to 24VDC

Current: Up to 3 Amps

Wire gauge: 20AWG

Number of contacts: 4



FEATURES

Single connecti on point for pneumatic, fluid, and power connections between a device and its tool/hand piece

Non-spill shutoff valves with dry-break technology

Turnkey solution

Off-the-shelf assembly

Custom options available

BENEFITS

Makes systems data more user friendly

Eliminate fluid drips upon disconnect and minimize air inclusion

Reduces multiple components

Minimizes engineering design and manufacturing effort

Flexibility to add additional fluid connector or electrical contacts



cpcworldwide.com/Hybrid-connector

HYBRID SERIES DIMENSIONS

COUPLING HOSE - Polypropylene



CONFIGURATION	FLOW PATHS	PART NO.	COLOR	A	B	C	D
HOSE	1/8" ID (3.2mm)	HQC17001	BLACK	2 (50.8)	2.8 (71.1)	3 (76.2)	8 (203.2)
	1/8" ID (3.2mm)	HQC17002	GREY	2 (50.8)	2.8 (71.1)	3 (76.2)	8 (203.2)

COUPLING PANEL - Polypropylene



CONFIGURATION	FLOW PATHS	PART NO.	COLOR	A	B	C
PANEL MOUNT	1/8" ID (3.2mm)	HQC42000	BLACK	1.96 (49.8)	1.12 (28.4)	12 (304.8)
	1/8" ID (3.2mm)	HQC42001	GREY	1.96 (49.8)	1.12 (28.4)	12 (304.8)

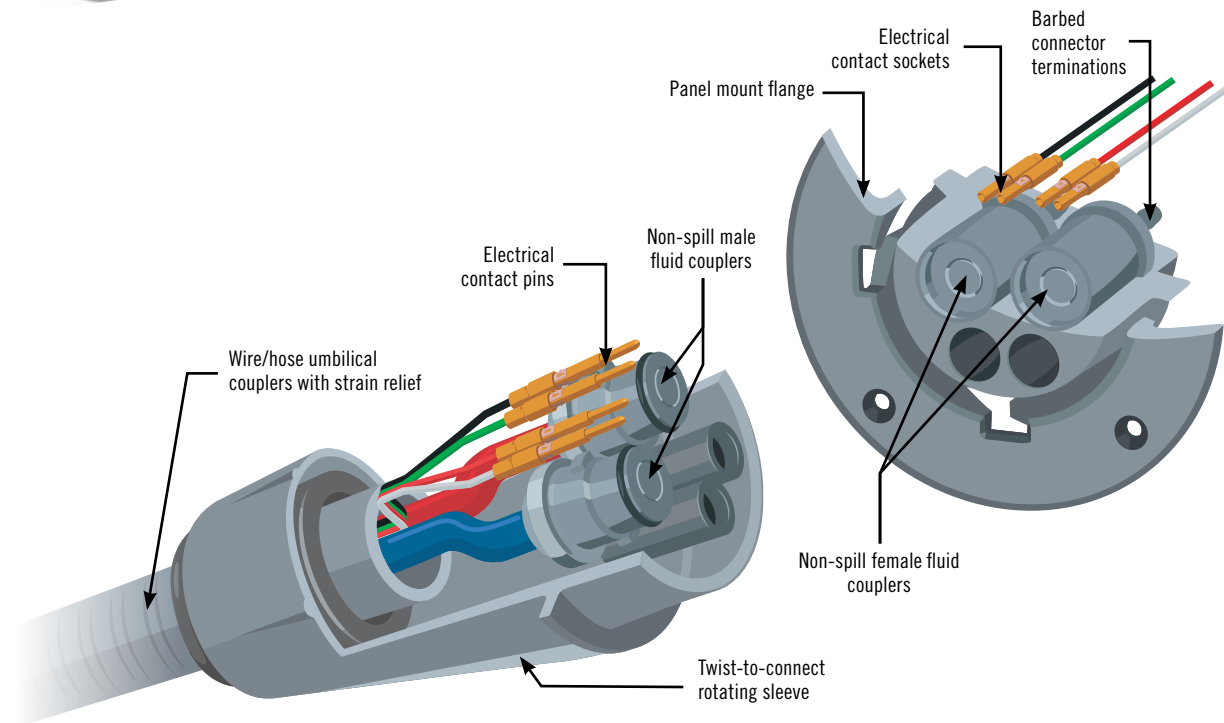

PRODUCT DIMENSIONS

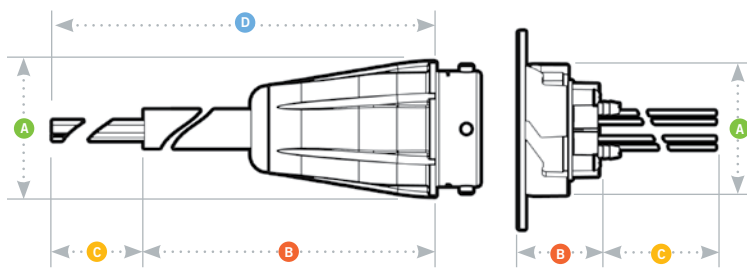

A = Height/Diameter B = Total Length C = Pigtail D = Umbilical

PANEL DIMENSIONS

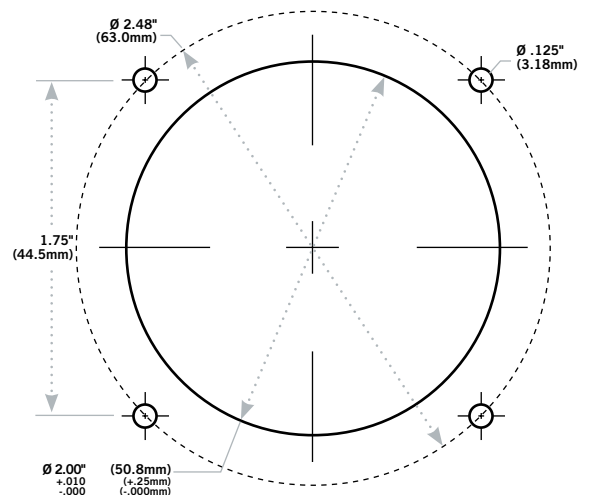

MINI HYBRID SERIES CONNECTOR

Mini Hybrid Connector – A compact, single connection point with a smaller form factor that is ideal for use in low-pressure applications where ease of use and ergonomics are important. This connector makes it easy to connect power, signal and gases in one simple motion.

SPECIFICATIONS

PRESSURE:

Vacuum to 25 psi, 1.7 bar

TEMPERATURE:

40°F to 80°F (4°C to 27°C)

MATERIALS:

External coupler components: PET

Air coupler components: Acetal

Springs: Stainless steel

Panel Mount Nut: Zinc-plated steel

Electrical contacts: Gold-plated copper alloy

O-rings: Buna-N

Air line: PVC

COLOR: Gray

EXTERNAL UMBILICAL HOSE:

4 feet (121 cm) PVC

WIRE: 22AWG PVC jacket

TERMINATIONS:

Panel: 1/16" hose barb and two 22AWG wires with 11" pigtail

Umbilical: 4' (121 cm) umbilical with one 1/16" ID PVC tube and two 22AWG wires with 6" pigtail

Number of air lines: 1

ELECTRICAL SPECIFICATIONS

Voltage: Up to 24VDC

Current: Up to 3 Amps

Wire: 22AWG with PVC jacket

Number of contacts: 2



cpcworldwide.com/MiniHybrid

FEATURES

Easy-to-use breakaway design →

Small package design →

Streamlined exterior →

Proven design →

BENEFITS

Quick, automatic disconnect

Minimize device size

Clean, attractive appearance

Accelerate product development

MINI HYBRID SERIES DIMENSIONS

COUPLING HOSE - Acetal



CONFIGURATION	FLOW PATHS	PART NO.	A	B
HOSE	1/16" ID (1.6mm)	MHQC17000	0.62 (15.7)	2 (50.8)

COUPLING PANEL - Acetal



CONFIGURATION	FLOW PATHS	PART NO.	A	B
PANEL MOUNT	1/16" ID (1.6mm)	MHQC42000	1 (25.4)	0.60 (15.2)

PRODUCT DIMENSIONS

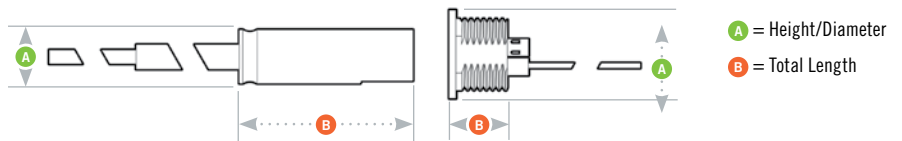

PANEL DIMENSIONS

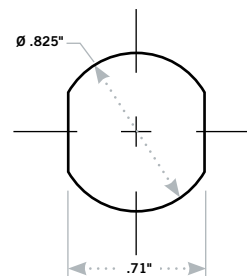

iMAR SERIES



IdentiQuik® Multiple Antenna RF-enabled communicator (MAR)

provides a convenient and economical solution for avoiding misconnections in a multiline environment. Designed to handle up to eight fluid connections, the MAR eliminates larger, individual RF-enabled communicators, which reduces redundancy and complexity of system design. Like all IdentiQuik RF-enabled products, the MAR makes controlling, protecting and streamlining fluid handling processes easier and more efficient. The MAR is compatible with all PLC12 panel-mounted bodies and PLC12 Series RFID-enabled inserts.

FEATURES

Palm-sized reader with one USB supporting up to eight fluid lines

Transfer of fluid and information for each flow path

Modular, detachable configurations per fluid line

BENEFITS

Simplifies design integration by eliminating larger, individual RF-enabled communicators

Identifies device types or connected media, verifies line connection and captures fluid and product data

Meets specifications for cables, coupling type, length, size and environment

iMAR BODIES



TERMINATION	PART NO.	A	B	C
iMAR	iMAR8000	0.94 (23.9)	4 (101.6)	2.4 (61.0)

ANTENNA



TERMINATION	PART NO.	A	B	C
ANTENNA	iANT10110		Cable: 39.37 inches (1.0 m)	
	iANT10410		Cable: 39.37 inches (1.0 m)	
	(set of 4)			

SPECIFICATIONS

COLOR:

MAR: Smoke gray plastic case
Antenna: Black

INTERFACE:

USB; connectorized cable included with antenna

OPERATING VOLTAGE:

5VDC

POWER CONSUMPTION:

1.2W maximum

RF COMMUNICATION RANGE:

Approximately 1"

COMPLIANCE:

RoHS, ISO 15693

PRODUCT DIMENSIONS

iMAR

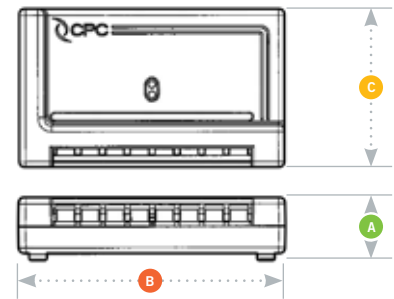

Antenna

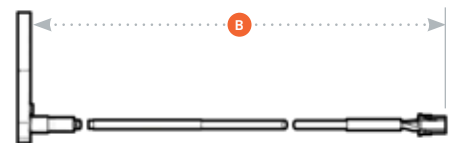

- A = Height
- B = Total Length
- C = Width

Panel / Cutout Footprint

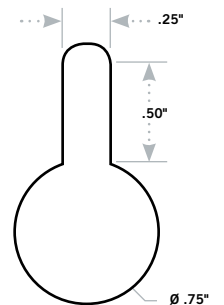



IdentiQuik couplings allow the robust transfer of fluid and information in a limitless number of applications across multiple industries. Examples of potential applications include:

- *Connection validation*
- *Media validation*
- *Operational control settings*
- *Usage control*
- *Track and trace*

RFID-based IdentiQuik® quick disconnect couplings redefine what's possible for controlling, protecting and streamlining fluid handling processes. A patented design embeds RFID-based electronic intelligence into a variety of our most popular and industry-leading coupling configurations, enabling the exchange of rewritable data once the coupling halves come within a few centimeters of one another. This intelligent technology allows you to protect your brand, minimize misconnections, prolong equipment life and increase efficiency.



IdentiQuik couplings are ideal for applications with a product involving: onboard electronics and parts or media that are consumable or expensive; the need to control the process to ensure the use of the right tool at the right time.

THOUSANDS OF CONFIGURATIONS TO MEET YOUR NEEDS

IdentiQuik couplings are available in a vast array of sizes and configurations that includes all our most popular product lines, opening endless new possibilities for your fluid handling processes.

Use this table to quickly find the right IdentiQuik coupling for your application. Can't find the ideal solution from our standard offering? Let our engineered solutions team design one for you.

FLOW CAPACITY

	
Medium PLC or NS4	Large UDC

SPILLAGE UPON DISCONNECT

		
None NS4	Minimal UDC	Minor PLC

IDENTIQUIK®

UDC COUPLING

IdentiQuik® Universal Dispensing Couplers (UDC) provide a universal connection to a 38mm fitment neck, allowing you to make instant connections to bulk packaging systems. The automatic flush face valves minimize costly or dangerous spillage, and an ergonomic design and large, shrouded thumb latch pad make the coupling easy to grip and simple to operate.

APPLICATIONS FOR UDC COUPLINGS INCLUDE:

- Bag-in-box, rigid, and flexible bulk packaging systems
- Additive Manufacturing
- Large-format and Ink Printing
- Many more

SPECIFICATIONS

PRESSURE:

20" Hg Vacuum to 15 psi, 1 bar (body only)

TEMPERATURE:

32°F to 150°F (0°C to 65°C)

MATERIALS:

Main body components and valves:

Polypropylene and Acetal

Thumb latch: Polypropylene

Springs: 316 stainless steel

O-rings (food grade): Silicone, Buna-N and EPDM

INTERFACE: 2-ft. (60 cm) cable with RS-232 or USB connector

OPERATING VOLTAGE:

RS-232: 8V – 24V • USB: 5V

POWER CONSUMPTION: *

1.2W maximum

RFID TAG:

ISO 15693, 13.56MHz, 112 bytes programmable







cpcworldwide.com/iUDC



IDENTIQUIK SERIES DIMENSIONS



UDC COUPLING READERS - Polypropylene

TERMINATION	TUBING/THREAD SIZE	METRIC EQ.	SHUTOFF	A	B
 IN-LINE HOSE BARB (RS-232 INTERFACE)	1/4" ID	6.4mm ID	iUDCDR1700400	2 (50.8)	3.49 (88.6)
	3/8" ID	9.5mm ID	iUDCDR1700600	2 (50.8)	3.49 (88.6)
	1/2" ID	12.7mm ID	iUDCDR1700800	2 (50.8)	3.49 (88.6)
	5/8" ID	15.9mm ID	iUDCDR1701000	2 (50.8)	3.49 (88.6)
	3/4" ID	19mm ID	iUDCDR1701200	2 (50.8)	3.49 (88.6)
 IN-LINE HOSE BARB (USB INTERFACE)	1/4" ID	6.4mm ID	iUDCDR1700401	2 (50.8)	3.49 (88.6)
	3/8" ID	9.5mm ID	iUDCDR1700601	2 (50.8)	3.49 (88.6)
	1/2" ID	12.7mm ID	iUDCDR1700801	2 (50.8)	3.49 (88.6)
 PANEL MOUNT HOSE BARB (RS-232 INTERFACE)	1/4" ID	6.4mm ID	iUDCDR1600400	For product dimensions visit cpcworldwide.com	
	3/8" ID	9.5mm ID	iUDCDR1600600		
	1/2" ID	12.7mm ID	iUDCDR1600800		
 PANEL MOUNT HOSE BARB (USB INTERFACE)	1/4" ID	6.4mm ID	iUDCDR1600401	For product dimensions visit cpcworldwide.com	
	3/8" ID	9.5mm ID	iUDCDR1600601		
	1/2" ID	12.7mm ID	iUDCDR1600801		

UDC COUPLING CAPS - Acetal

TERMINATION	TUBING/THREAD SIZE	METRIC EQ.	SHUTOFF	A	B
 THREAD-ON 38MM VALVED	Without thread seal	38mm	iUDCDTCN3803	1.7 (43.2)	1.47 (37.3)
	With thread seal	38mm	iUDCDTCS3803	1.7 (43.2)	1.47 (37.3)

UDC COUPLING CAPS - Polypropylene

TERMINATION	TUBING/THREAD SIZE	METRIC EQ.	SHUTOFF	A	B
 SNAP-IN 38MM VALVED		38mm	iUDCDTSN0000	1.62 (41.1)	1.76 (44.7)
 THREAD-ON 38MM VALVED	Without thread seal	38mm	iUDCDTCN3800	1.7 (43.2)	1.48 (37.6)
	With thread seal	38mm	iUDCDTCS3800	1.7 (43.2)	1.48 (37.6)

CHEMICAL-RESISTANT AND HIGHLY VERSATILE

IDENTIQUIK® PLC12 COUPLING



IdentiQuik® PLC12 Couplings are injection-molded from polypropylene thermoplastic and are resistant to many chemical solutions.

This popular coupling features one-hand connection and disconnection, and offers the flexibility of multiple configurations and terminations. Its polypropylene provides superior chemical resistance, and the EPDM o-ring adds expanded chemical compatibility for more demanding applications.

PLC12 couplings can be ordered in a vast range of sizes and configurations to meet the needs of your application.

APPLICATIONS FOR PLC12 COUPLINGS INCLUDE:

- Flavor concentrates
- Cosmetic ingredients
- Laser cooling
- Many more

COUPLING READERS - Polypropylene

TERMINATION	TUBING/ THREAD SIZE	METRIC EQ.	STRAIGHT THRU	SHUTOFF	A	B
 IN-LINE HOSE BARB (USB INTERFACE)	1/4" ID	6.4mm ID		iPLCDR1700400	1.39 (35.3)	2.78 (70.6)
	3/8" ID	9.5mm ID		iPLCDR1700600	1.39 (35.3)	2.78 (70.6)
IN-LINE HOSE BARB (USB INTERFACE)	1/4" ID	6.4mm ID		iPLCD1700401	1 (25.4)	1.38/2.05 (35.1/52.1)
	3/8" ID	9.5mm ID		iPLCDR1700601	1.05 (26.7)	1.74/1.87 (44.2/47.5)

COUPLING INSERTS - Polypropylene

TERMINATION	TUBING/ THREAD SIZE	METRIC EQ.	STRAIGHT THRU	SHUTOFF	A	B
 IN-LINE HOSE BARB (USB INTERFACE)	1/4" ID	6.4mm ID	iPLCT2200400	iPLCDT2200400	1.39 (35.3)	2.78 (70.6)
	3/8" ID	9.5mm ID	iPLCT2300600	iPLCDT2300600	1.48 (37.6)	1.33/1.46 (33.8/37.1)

All measurements are in inches (millimeters) unless otherwise noted. Tubing must meet stated inside and outside diameters. Couplings are pictured with valves unless otherwise noted.

SPECIFICATIONS

PRESSURE:

Vacuum to 120 psi, 8.3 bar

TEMPERATURE:

32°F to 150°F (0°C to 65°C)

MATERIALS:

Main components and valves: Polypropylene

Thumb latch: Stainless steel

Valve spring: 316 stainless steel

External springs and pin: Stainless steel

O-rings: EPDM

COLOR: Almond

TUBING SIZE:

1/4" to 3/8", 6.4mm to 9.5mm

INTERFACE:

Multi-drop 2-ft. (60 cm) cable with RS-232 or USB connector

OPERATING VOLTAGE:

RS-232: 8V – 24V

USB: 5V

POWER CONSUMPTION:

1.2W maximum

RF COMMUNICATION RANGE:

Approximately 1"

RFID TAG:

ISO 15693, 13.56MHz, 112 bytes programmable



cpcworldwide.com/iPLC12

FAST, SAFE AND LEAK-FREE FLUID CONNECTIONS

IDENTIQUIK[®]

NS4 NON-SPILL (NS) COUPLING



Identiquik[®] NS4 Non-Spill (NS) Couplings are injection-molded from polypropylene thermoplastic and are resistant to many chemical solutions.

This popular coupling features one-hand connection and disconnection, and offers the flexibility of multiple configurations and terminations. Its polypropylene provides superior chemical resistance, and the EPDM o-ring adds expanded chemical compatibility for more demanding applications.

APPLICATIONS FOR NS4 COUPLINGS INCLUDE:

- Large-format and inkjet printing
- Additive Manufacturing
- Blood analysis
- Many more

COUPLING READERS - Polypropylene

TERMINATION	TUBING/THREAD SIZE	METRIC EQ.	SHUTOFF	A	B
 IN-LINE HOSE BARB (RS-232 INTERFACE)	1/8" ID	3.2mm	iNS4DR1700200	2.15 (54.6)	3.49 (88.6)
	1/4" ID	6.4mm	iNS4DR1700400	2.15 (54.6)	3.49 (88.6)
	3/8" ID	9.5mm	iNS4DR1700600	2.15 (54.6)	3.49 (88.6)
IN-LINE HOSE BARB (USB INTERFACE)	1/8" ID	6.4mm ID	iNS4DR1700201	2.15 (54.6)	3.4 (86.4)
	1/4" ID	9.5mm ID	iNS4DR1700401	2.15 (54.6)	3.4 (86.4)
	3/8" ID	12.7mm ID	iNS4DR1700601	2.15 (54.6)	3.4 (86.4)

COUPLING INSERTS - Polypropylene

TERMINATION	TUBING/THREAD SIZE	METRIC EQ.	SHUTOFF	A	B
 IN-LINE HOSE BARB (RS-232 INTERFACE)	1/8" ID	3.2mm	iNS4DT2200200	For product	
	1/4" ID	6.4mm	iNS4DT2200400	dimensions visit	
	3/8" ID	9.5mm	iNS4DT2200600	cpcworldwide.com	

All measurements are in inches (millimeters) unless otherwise noted. Tubing must meet stated inside and outside diameters. Couplings are pictured with valves unless otherwise noted.

SPECIFICATIONS

PRESSURE: Vacuum to 120 psi, 8.3 bar

TEMPERATURE:
32°F to 150°F (0°C to 65°C)

MATERIALS:

Main body components and valves:

Glass-filled polypropylene

Thumb latch: Glass-filled polypropylene

Springs: 316 stainless steel

Valve spring: 316 stainless steel

External spring: 316 stainless steel

O-rings: EPDM (FKM optional)

Soft-touch overmold: TPV*

COLOR: Gray with dark gray overmold

LUBRICANTS: Krytox[®] PFPE (inert)

TUBING SIZE:

1/8" to 3/8", 3.2mm to 9.5mm

INTERFACE:

Multi-drop 2-ft. (60 cm) cable with RS-232 or USB connector

OPERATING VOLTAGE:

RS-232: 8V – 24V

USB: 5V

POWER CONSUMPTION:

1.2W maximum

RF COMMUNICATION RANGE:

Approximately 1"

RFID TAG:

ISO 15693, 13.56MHz, 112 bytes programmable

*The overmold material is known as TPV (thermoplastic vulcanizate). This TPV is an alloy of polypropylene thermoplastic and fully vulcanized EPDM rubber. The material is typically resistant to water, acids and bases.



cpcworldwide.com/iNS4



Trust CPC medical grade couplings to deliver quick and easy air and fluid handling for medical applications

CPC medical grade couplings meet the stringent biocompatibility, sterility and cleanroom manufacturing requirements found in a wide variety of medical fluid transfer applications. They're engineered for cleaner and more efficient fluid handling. Medical-grade material meets the most stringent requirements such as USP Class VI, MEM elution, agarose overlay, hemolysis in vitro and USP physicochemical tests.

Choose from a full line of medical-grade couplings built on an intuitive design that is simple for end users to operate.

- Audible "click" for added assurance of a secure, leak-free connection
- Full line of connector types, sizes to fit 1/16" to 1/2" tubing and configurations
- Ergonomic thumb latches for easy operation—even with gloved hands
- Cleanroom products shipped in double heat-sealed bags
- Options to connect single-use systems and reducing options to transition between tubing diameters

Select CPC medical grade couplings and connectors for compatibility with the physical, chemical, and biological needs of fluid connections for medical devices, instruments and equipment.

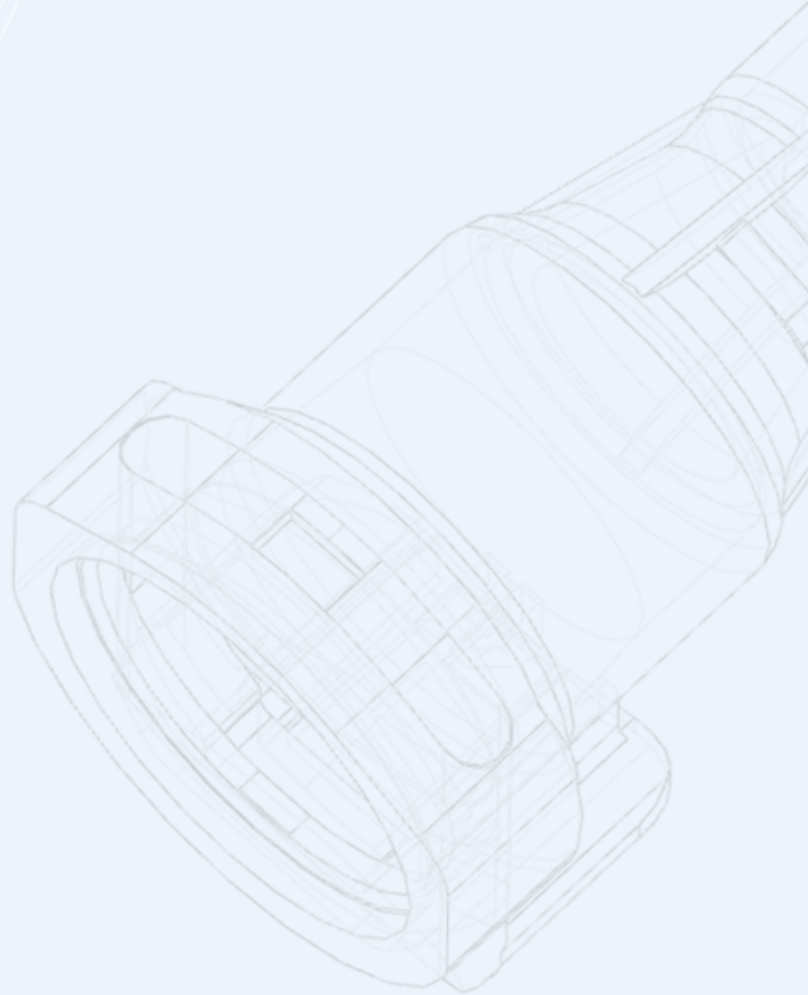

MEDICAL GRADE
Couplings and Connectors

SMC SERIES CONNECTOR

The SMC is a twist-to-connect coupling that provides a reliable and more secure alternative to luer-type connections. It also allows for the tubing to rotate freely when connected. This important feature prevents both kinked tubing and accidental disconnection during use.



SPECIFICATIONS

PRESSURE:

Vacuum to 100 psi, 6.9 bar

TEMPERATURE:

-40°F to 250°F (-40°C to 121°C)

MATERIALS:

Main components: Polycarbonate, USP Class VI, ADCF

Locking sleeves: Polycarbonate, USP Class VI, ADCF

O-rings: Buna-N, USP Class V, ADCF

COLOR:

Main components: Purple tint

STERILIZATION:

Gamma: Up to 50 kGy irradiation

TUBING SIZES:

1/16" to 1/8" ID, 1.6mm to 3.2mm ID



cpcworldwide.com/SMC

FEATURES

Twist to connect



BENEFITS

Prevents accidental disconnects

Free coupling rotation



Eliminates kinked tubing

Safer; prevents misconnections



Does not mate to luers

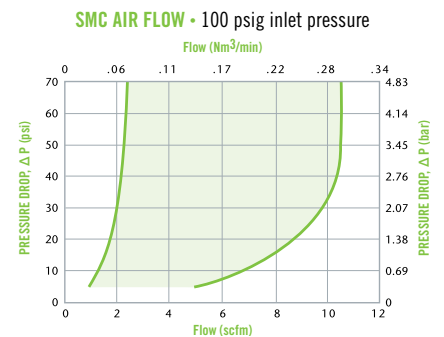
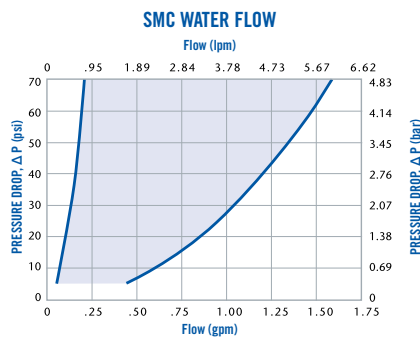

These graphs are intended to give you a general idea of the performance capabilities of each product line. The shaded area of each graph represents the operating range of the product family, i.e., upper and lower values are shown. Therefore, depending on the exact coupling configurations selected, you can reasonably expect values to fall within the shaded area.

SMC SERIES DIMENSIONS

COUPLING BODIES - Polycarbonate



TERMINATION	TUBING SIZE	METRIC EQ.	STRAIGHT THRU	A	B
IN-LINE HOSE BARB	1/16" ID	1.6mm ID	SMF0191	0.48 (12.2)	0.75/0.90 (19.1/22.9)
	1/8" ID	3.2mm ID	SMF0291	0.48 (12.2)	0.9 (22.9)

COUPLING INSERTS - Polycarbonate



TERMINATION	TUBING SIZE	METRIC EQ.	STRAIGHT THRU	A	B
IN-LINE HOSE BARB	1/16" ID	1.6mm ID	SMM0191	0.48 (12.2)	0.75 (19.1)
	1/8" ID	3.2mm ID	SMM0291	0.48 (12.2)	0.9 (22.9)

COUPLING SET - Polycarbonate



TERMINATION	TUBING SIZE	METRIC EQ.	STRAIGHT THRU	A	B
HOSE BARB	1/16" ID	1.6mm ID	SMC0191	0.48 (12.2)	1.32 (33.5)
	1/8" ID	3.2mm ID	SMC0291	0.48 (12.2)	1.61 (40.9)

All measurements are in inches (millimeters) unless otherwise noted. Tubing must meet stated inside and outside diameters. PTF fittings are designed for semi-rigid tubing, i.e., polyethylene, nylon, polyurethane, etc. *NOTE: CPC's Ferruleless PTF (polytube fitting) terminations do not require ferrules to achieve a secure connection and are therefore easier to use and reuse.

PRODUCT DIMENSIONS

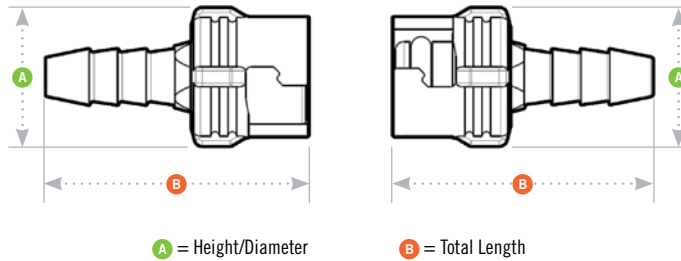

LIQUID FLOW RATE INFORMATION FOR COUPLINGS

The chart below shows the flow rate for CPC couplings. Each coupling was tested with water at 70°F (21°C). To determine flow rates for specific coupling configurations use the formula below.

C_v VALUES

BODIES	INSERTS	
	SMM01	SMM02
SMF01	0.03	0.03
SMF02	0.03	0.19

$$Q = C_v \sqrt{\frac{\Delta P}{S}}$$

Q = Flow rate in gallons per minute
C_v = Average coefficient across various flow rates (see chart)
ΔP = Pressure drop across coupling (psi)
S = Specific gravity of liquid

MPC™ SERIES CONNECTOR

The MPC™ series couplings add ease of use and security to critical fluid handling applications. Choose from a full line of connectors and configurations, including pressure sealing caps and plugs, in sizes to fit 1/8" to 3/8" tubing. MPC couplings offer optional locking sleeves to further guard against accidental disconnects. In addition, coupling halves can be rotated when connected to reduce tube kinks.

SPECIFICATIONS

OPERATING PRESSURE:

Vacuum to 60 psi, 4.1 bar

OPERATING TEMPERATURE:

ABS:

-40°F to 160°F (-40°C to 71°C)

Polycarbonate:

-40°F to 250°F (-40°C to 121°C)

Polysulfone:

-40°F to 300°F (-40°C to 149°C)

MATERIALS:

Main components:

ABS (white), USP Class VI, Polycarbonate (purple tint), USP Class VI, ADCF Polysulfone (amber tint), USP Class VI, ADCF

Locking sleeves:

Polysulfone (white), USP Class VI, ADCF

Thumb Latches:

Polycarbonate (white), USP Class VI, ADCF Polysulfone (amber tint), USP Class VI, ADCF

O-rings: Silicone (clear), platinum-cured, USP Class VI, ADCF and Buna-N (black), USP Class V

STERILIZATION:

Gamma: Up to 50 kGy irradiation

Autoclave:

Polycarbonate: Up to 250°F (121°C), 30 minutes, up to 10 repetitions. Sterilize uncoupled only.

Polysulfone: Up to 270°F (132°C) for 60 minutes, up to 25 repetitions. Sterilize uncoupled only.

TUBING SIZES:

1/8" to 3/8" ID (3.2mm to 9.5mm)

WARNING: Pressure, temperature, chemicals, and operating environment can affect the performance of couplings. It is the customer's responsibility to test the suitability of CPC's products in their own application conditions.



FEATURES

- Ergonomic thumb latch → Easy to operate – even with gloved hands
- USP Class VI materials → Meet biocompatibility requirements
- Sterilizable by autoclave, EtO, e-beam, or gamma → Reusable, yet economical enough to allow disposability
- Parting line-free hose barb → Eliminates potential leak path
- ADCF-free materials → Meet BSE/TSE requirements

BENEFITS

NOTE

MPC Series mates with Back-to-Back Adapters, SaniQuik™ and Sanitary Series.

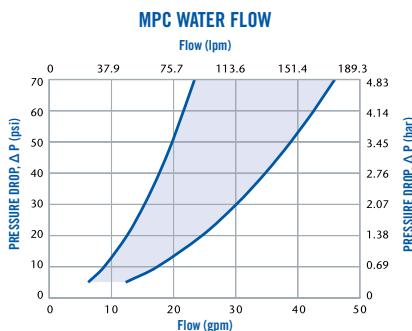





This graph is intended to give you a general idea of the performance capabilities of each product line. The shaded area of the graph represents the operating range of the product family, i.e. upper and lower values are shown. Therefore, depending on the exact coupling configurations selected, you can reasonably expect values to fall within the shaded area.







cpcworldwide.com/MPC

MPC™ SERIES DIMENSIONS

COUPLING BODIES - ABS / Polycarbonate / Polysulfone

TERMINATION	TUBING SIZE	METRIC EQ	FLOW	STRAIGHT THRU	O-RINGS	A	B
 ABS IN-LINE HOSE BARB	1/4" ID	6.4mm ID	0.21"	MPC17004T		0.96 (24.4)	1.3 (33.0)
	3/8" ID	9.5mm ID	0.29"	MPC17006T		0.96 (24.4)	1.3 (33.0)
 POLYCARBONATE IN-LINE HOSE BARB	1/8" ID	3.2mm ID	0.09"	MPC17002T03		0.96 (24.4)	1.1 (27.9)
	1/4" ID	6.4mm ID	0.21"	MPC17004T03		0.96 (24.4)	1.1 (27.9)
	3/8" ID	9.5mm ID	0.29"	MPC17006T03		0.96 (24.4)	1.1 (27.9)
 POLYCARBONATE IN-LINE HOSE BARB WITH LOCK	1/8" ID	3.2mm ID	0.09"	MPCK17002T03		0.99 (25.1)	1.1 (27.9)
	1/4" ID	6.4mm ID	0.21"	MPCK17004T03		0.99 (25.1)	1.3 (33.0)
	3/8" ID	9.5mm ID	0.29"	MPCK17006T03		0.99 (25.1)	1.3 (33.0)
 POLYSULFONE IN-LINE HOSE BARB	1/8" ID	3.2mm ID	0.09"	MPC17002T39		0.96 (24.4)	1.1 (27.9)
	1/4" ID	6.4mm ID	0.21"	MPC17004T39		0.96 (24.4)	1.1 (27.9)
	3/8" ID	9.5mm ID	0.29"	MPC17006T39		0.96 (24.4)	1.1 (27.9)
 POLYSULFONE IN-LINE HOSE BARB WITH LOCK	1/8" ID	3.2mm ID	0.09"	MPCK17002T39		0.99 (25.1)	1.1 (27.9)
	1/4" ID	6.4mm ID	0.21"	MPCK17004T39		0.99 (25.1)	1.3 (33.0)
	3/8" ID	9.5mm ID	0.29"	MPCK17006T39		0.99 (25.1)	1.3 (33.0)

COUPLING INSERTS - ABS / Polycarbonate / Polysulfone

TERMINATION	TUBING SIZE	METRIC EQ	FLOW	STRAIGHT THRU	O-RINGS	A	B
 ABS IN-LINE HOSE BARB	1/4" ID	6.4mm ID	0.21"	MPC22004TM	Silicone Seal USP Class VI	0.6 (15.2)	1.3 (33.0)
	3/8" ID	9.5mm ID	0.29"	MPC22006TM	Silicone Seal USP Class VI	0.6 (15.2)	1.3 (33.0)
 ABS IN-LINE HOSE BARB	1/4" ID	6.4mm ID	0.21"	MPC22004T	Buna-N Seal USP Class V	0.6 (15.2)	1.3 (33.0)
	3/8" ID	9.5mm ID	0.29"	MPC22006T	Buna-N Seal USP Class V	0.6 (15.2)	1.3 (33.0)
 POLYCARBONATE IN-LINE HOSE BARB	1/8" ID	3.2mm ID	0.09"	MPC22002T03M	Silicone Seal USP Class VI	0.6 (15.2)	1.1 (27.9)
	1/4" ID	6.4mm ID	0.21"	MPC22004T03M	Silicone Seal USP Class VI	0.6 (15.2)	1.3 (33.0)
	3/8" ID	9.5mm ID	0.29"	MPC22006T03M	Silicone Seal USP Class VI	0.6 (15.2)	1.3 (33.0)
 POLYSULFONE IN-LINE HOSE BARB	1/8" ID	3.2mm ID	0.09"	MPC22002T03	Buna-N Seal USP Class V	0.6 (15.2)	1.1 (27.9)
	1/4" ID	6.4mm ID	0.21"	MPC22004T03	Buna-N Seal USP Class V	0.6 (15.2)	1.3 (33.0)
	3/8" ID	9.5mm ID	0.29"	MPC22006T03	Buna-N Seal USP Class V	0.6 (15.2)	1.3 (33.0)
 POLYSULFONE IN-LINE HOSE BARB	1/8" ID	3.2mm ID	0.09"	MPC22002T39M	Silicone Seal USP Class VI	0.6 (15.2)	1.1 (27.9)
	1/4" ID	6.4mm ID	0.21"	MPC22004T39M	Silicone Seal USP Class VI	0.6 (15.2)	1.3 (33.0)
	3/8" ID	9.5mm ID	0.29"	MPC22006T39M	Silicone Seal USP Class VI	0.6 (15.2)	1.3 (33.0)

PRODUCT DIMENSIONS

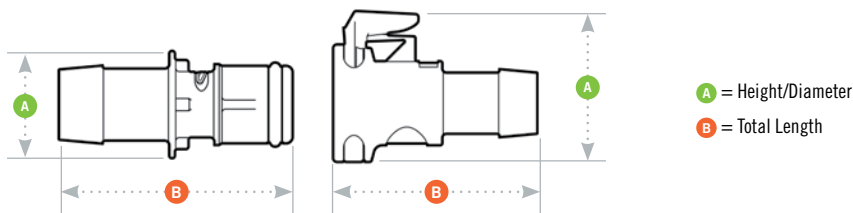

MPC™ SERIES CONNECTOR (CONT.)

ADAPTORS



SEALING CAP	W/LOCK	MATERIAL	A	B
MPC32003	MPCK32003	Polycarbonate	0.96 (24.4 mm)	1.3 (33.0 mm)
MPC32039	MPCK32039	Polysulfone	0.99 (25.1 mm)	1.3 (33.0 mm)

SEALING PLUG	O-RING	MATERIAL	A	B
MPC30003M	Silicone Seal USP Class VI	Polycarbonate	0.75 (19.1 mm)	1.24 (31.5 mm)
MPC30039M	Silicone Seal USP Class VI	Polysulfone	0.75 (19.1 mm)	1.24 (31.5 mm)

PART NO.	DESCRIPTION	MATERIAL
MPC30L	Leash plug for MPC body	Soft, flexible, medical-grade PVC
MPC32L	Leash plug for MPC insert	Soft, flexible, medical-grade PVC

LIQUID FLOW RATE INFORMATION FOR COUPLINGS

The chart below shows the flow rate for CPC couplings. Each coupling was tested with water at 70°F (21°C). To determine flow rates for specific coupling configurations use the formula below.

C_v VALUES

INSERTS

BODIES

	MPC22002T03	MPC22004T03	MPC22006T03
MPC17002T03	0.11	-	0.21
MPC17004T03	-	2.8	2.8
MPC17006T03	0.14	2.8	5.5

$$Q = C_v \sqrt{\frac{\Delta P}{S}}$$

- Q = Flow rate in gallons per minute
- C_v = Average coefficient across various flow rates (see chart)
- ΔP = Pressure drop across coupling (psi)
- S = Specific gravity of liquid

BACK-TO-BACK PRODUCT DIMENSIONS

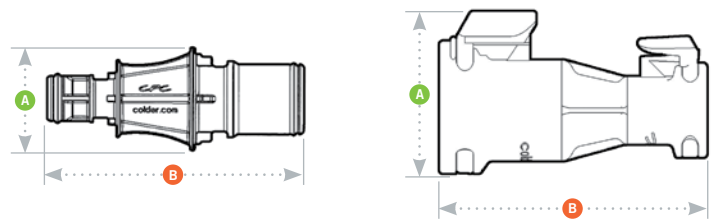

A = Height/Diameter B = Total Length

BACK-TO-BACK SERIES CONNECTOR



MPC™/MPX® Back-to-Back Adapters give end users the flexibility of connecting single-use systems that feature identical coupling connections at the end of their tubing. Combining both MPC and MPX couplings provides a reducing option for users who need to transition between tubing diameters ranging from 1/8" to 1/2".

FEATURES

Compatible with MPC and MPX Series inserts



BENEFITS

Easy conversion to industry standard connections or single-use systems

Tubing reduction option



Allows easy transition between multiple size tubing from 1/8" to 1/2" ID

Ergonomic thumb latches



Easy to operate - even with gloved hands

ADCF-free materials



Meet BSE/TSE requirements

BACK-TO-BACK INSERT ADAPTORS - Polysulfone



PART NO.	TYPE	A	B
MPC22C2239M	MPC to MPC	0.74 (18.8)	2.04 (51.8)
MPC22X2239M	MPC to MPX	0.98 (24.9)	2.42 (61.5)
MPX22X2239M	MPX to MPX	0.98 (24.9)	2.73 (69.3)

BACK-TO-BACK BODY ADAPTORS - Polycarbonate



PART NO.	TYPE	A	B
MPC17C1703	MPC to MPC	0.96 (24.4)	1.81 (46.0)
MPX17X1703	MPX to MPX	1.28 (32.5)	2.44 (62.0)
MPC17X1703	MPC to MPX	1.28 (32.5)	2.13 (54.1)

BACK-TO-BACK BODY ADAPTORS - Polysulfone



PART NO.	TYPE	A	B
MPC17C1739	MPC to MPC	0.96 (24.4)	1.81 (46.0)
MPX17X1739	MPX to MPX	1.28 (32.5)	2.44 (62.0)
MPC17X1739	MPC to MPX	1.28 (32.5)	2.13 (54.1)

All measurements are in inches (millimeters) unless otherwise noted. Tubing must meet stated inside and outside diameters.

SPECIFICATIONS

PRESSURE:

Vacuum to 60 psi, 4.1 bar

TEMPERATURE:

Polycarbonate:

-40°F to 250°F (-40°C to 121°C)

Polysulfone:

-40°F to 300°F (-40°C to 149°C)

MATERIALS:

Main Components:

Polycarbonate (purple tint), USP Class VI, ADCF

Polysulfone (amber tint), USP Class VI, ADCF

Thumb Latches:

Polycarbonate (white), USP Class VI, ADCF

Polysulfone (amber tint), USP Class VI, ADCF

O-rings:

Silicone (clear), platinum-cured, USP Class VI, ADCF

STERILIZATION:

Gamma: Up to 50 kGy irradiation

Autoclave:

Polycarbonate: Up to 250°F (121°C) for 30 minutes, up to 10 repetitions.

Sterilize uncoupled only.

Polysulfone: Up to 270°F (132°C) for 60 minutes, up to 25 repetitions.

Sterilize uncoupled only.

WARNING: Pressure, temperature, chemicals, and operating environment can affect the performance of couplings. It is the customer's responsibility to test the suitability of CPC's products in their own application conditions.

NOTE

Mates with MPC and MPX bodies, inserts and sealing caps and plugs (pages 124-128).



cpcworldwide.com/Back-to-back-Adapters

MPX[®] SERIES CONNECTOR

MPX[®] Series couplings add ease of use and security to your most critical fluid handling applications. Choose from a full line of connectors and configurations, including pressure sealing caps and plugs in sizes to fit 3/8" and 1/2" tubing. MPX couplings offer optional locking sleeves to further guard against accidental disconnects. In addition, coupling halves can be rotated when connected reducing tube kinks.



SPECIFICATIONS

PRESSURE:

Vacuum to 60 psi, 4.1 bar

TEMPERATURE:

Polycarbonate:

-40°F to 250°F (-40°C to 121°C)

Polysulfone:

-40°F to 300°F (-40°C to 149°C)

MATERIALS:

Main components:

Polycarbonate (purple tint), USP Class VI, ADCF

Polysulfone (amber tint), USP Class VI, ADCF

Locking sleeves:

Polysulfone (white), USP Class VI, ADCF

Thumb Latches:

Polycarbonate (white), USP Class VI, ADCF

Polysulfone (amber tint), USP Class VI, ADCF

O-rings: Silicone (clear), platinum-cured, USP Class VI, ADCF

STERILIZATION:

Gamma: Up to 50 kGy irradiation

Autoclave:

Polycarbonate: Up to 250°F (121°C), 30 minutes, up to 10 repetitions. Sterilize uncoupled only.

Polysulfone: Up to 270°F (132°C) for 60 minutes, up to 25 repetitions. Sterilize uncoupled only.

TUBING SIZES:

3/8" to 1/2" ID (9.5mm to 12.7mm)

WARNING: Pressure, temperature, chemicals, and operating environment can affect the performance of couplings. It is the customer's responsibility to test the suitability of CPC's products in their own application conditions.

FEATURES

Ergonomic thumb latch →

USP Class VI materials →

Sterilizable by autoclave, EtO, e-beam, or gamma →

Parting line-free hose barb →

ADCF-free materials →

BENEFITS

Easy to operate – even with gloved hands

Meet biocompatibility requirements

Reusable, yet economical enough to allow disposability

Eliminates potential leak path

Meet BSE/TSE requirements

NOTE

MPX Series also mates with Back to Back Adapters

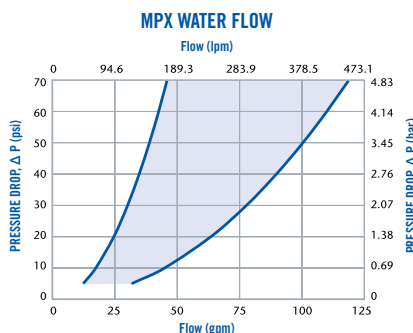



This graph is intended to give you a general idea of the performance capabilities of each product line. The shaded area of the graph represents the operating range of the product family, i.e. upper and lower values are shown. Therefore, depending on the exact coupling configurations selected, you can reasonably expect values to fall within the shaded area.





cpcworldwide.com/MPX

MPX® SERIES DIMENSIONS

COUPLING BODIES - Polycarbonate

TERMINATION	TUBING	METRIC EQ.	FLOW	STRAIGHT THRU	A	B
 IN-LINE HOSE BARB	1/2" ID	12.7mm ID	0.50"	MPX17803	1.28 (32.5)	1.96 (49.8)
 IN-LINE HOSE BARB WITH LOCK	1/2" ID	12.7mm ID	0.50"	MPXK17803	1.28 (32.5)	1.96 (49.8)

COUPLING BODIES - Polysulfone

TERMINATION	TUBING	METRIC EQ.	FLOW	STRAIGHT THRU	A	B
 IN-LINE HOSE BARB	1/2" ID	12.7mm ID	0.50"	MPX17839	1.28 (32.5)	1.96 (49.8)
 IN-LINE HOSE BARB WITH LOCK	1/2" ID	12.7mm ID	0.50"	MPXK17839	1.28 (32.5)	1.96 (49.8)





COUPLING INSERTS - Polycarbonate

TERMINATION	TUBING	METRIC EQ.	FLOW	STRAIGHT THRU	O-RING	A	B
 IN-LINE HOSE BARB	3/8" ID	9.5mm ID	0.38"	MPX22603M	Silicone Seal USP Class VI	0.85 (21.6)	1.9 (48.3)
	1/2" ID	12.7mm ID	0.50"	MPX22803M	Silicone Seal USP Class VI	0.85 (21.6)	1.9 (48.3)

COUPLING INSERTS - Polysulfone

TERMINATION	TUBING	METRIC EQ.	FLOW	STRAIGHT THRU	O-RING	A	B
 IN-LINE HOSE BARB	3/8" ID	9.5mm ID	0.38"	MPX22639M	Silicone Seal USP Class VI	0.85 (21.6)	1.9 (48.3)
	1/2" ID	12.7mm ID	0.50"	MPX22839M	Silicone Seal USP Class VI	0.85 (21.6)	1.9 (48.3)

MATING PARTS

		SEALING CAP	W/LOCK	MATERIAL	A	B
		MPX32003	MPXK32003	Polycarbonate	1.28 (32.5)	1.67 (42.4)
		MPX32039	MPXK32039	Polysulfone	1.28 (32.5)	1.67 (42.4)
		SEALING PLUG	O-RING	MATERIAL	A	B
		MPX30003M	Silicone Seal USP Class VI	Polycarbonate	1.1 (27.9)	1.66 (42.2)
		MPX30039M	Silicone Seal USP Class VI	Polysulfone	1.1 (27.9)	1.66 (42.2)

All measurements are in inches (millimeters) unless otherwise noted. Tubing must meet stated inside and outside diameters.

PRODUCT DIMENSIONS

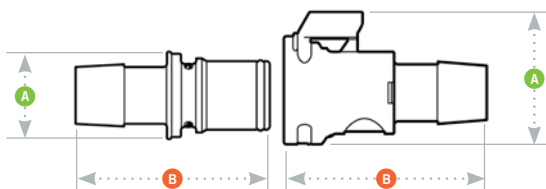

A = HEIGHT/DIAMETER
B = TOTAL LENGTH

SANITARY SERIES CONNECTOR

Sanitary couplings attach directly to 3/4", 1" and 1-1/2" sanitary terminations to provide greater flexibility for integrating components into single-use or hybrid (single-use to stainless) process systems. Standard bag systems with quick couplings can be easily connected to equipment with sanitary terminations, while single-use cartridge filters can be converted to incorporate quick couplings for greater system modularity.



SPECIFICATIONS

PRESSURE:

Vacuum to 60 psi, 4.1 bar

OPERATING TEMPERATURE:

-40°F to 300°F (-40°C to 149°C)

STERILIZATION:

Gamma: Up to 50 kGy irradiation

Autoclave: Up to 270°F (132°C) for 60 minutes, up to 25 repetitions. Sterilize uncoupled only.

TERMINATIONS:

3/4", 1" and 1-1/2" sanitary

MATERIALS:

Main components:

Polysulfone (amber tint), USP Class VI, ADCF

Thumb Latches:

PVDF (white), USP Class VI, ADCF

O-rings: Silicone (clear), platinum-cured,

USP Class VI, ADCF

WARNING: Pressure, temperature, chemicals, and operating environment can affect the performance of couplings. It is the customer's responsibility to test the suitability of CPC's products in their own application conditions.

FEATURES

3/4", 1" and 1-1/2" sanitary terminations →

Compatible with MPC™ and MPX® Series couplings →

Integral coupling adaptor →

ADCF-free materials →

BENEFITS

Install to equipment with sanitary gaskets and sanitary clamps

Quick and easy connections to industry standard plastic couplings

Provides flexibility to easily convert sanitary terminations on filter cartridge or equipment

Meet BSE/TSE requirements



cpcworldwide.com/Sanitary

NOTE

Mates with MPC and MPX bodies, inserts and sealing caps and plugs and Back-to-Back Adapters (pages 124-129).

SANITARY SERIES DIMENSIONS

COUPLING BODIES - Polysulfone



PART NO.	SIZE	A	B	C
MPC3301239	3/4"	0.98 (24.9)	1.4 (35.6)	1 (25.4)
MPX3301239	3/4"	1.28 (32.5)	1.7 (43.2)	1 (25.4)
MPC3301639	1"	1.5 (38.1)	1.4 (35.6)	1.5 (38.1)

COUPLING INSERTS - Polysulfone



PART NO.	SIZE		A	B	C
MPC44012T39M	3/4"	Silicone Seal USP Class VI	0.98 (24.9)	1.4 (35.6)	1 (25.4)
MPC44024T39M	1-1/2"	Silicone Seal USP Class VI	1.98 (50.3)	1.4 (35.6)	1 (25.4)
MPX44012T39M	3/4"	Silicone Seal USP Class VI	0.98 (24.9)	1.71 (43.4)	
MPX44024T39M	1-1/2"	Silicone Seal USP Class VI	1.98 (50.3)	1.71 (43.4)	

All measurements are in inches (millimeters) unless otherwise noted. Tubing must meet stated inside and outside diameters.
 Note: Sanitary couplings are compatible with both stainless steel and plastic clamps. Clamps and gaskets are referenced for illustration and are not available through CPC.

PRODUCT DIMENSIONS

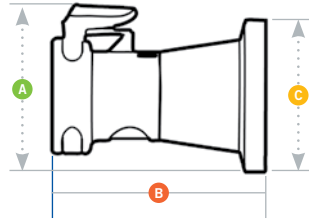
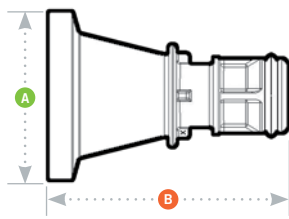

- A = Height/Diameter
- B = Total Length
- C = Hose Barb Length

NOTES

SANIQUIK™ SERIES CONNECTOR

CPC's SaniQuik™ connection answers the question of how to integrate single-use components with your existing stainless processing equipment. This integral sanitary termination attaches to hard-plumbed systems with tri-clover clamps. Once attached it permits quick and easy connection to single-use bag systems, manifolds or tube sets with CPC disposable coupling bodies. SaniQuik connections reduce sanitary gasket replacement, enabling cost-effective media transfer solutions for feeding, harvesting or sampling applications.



SPECIFICATIONS

PRESSURE:

Vacuum to 60 psi, 4.1 bar

TEMPERATURE:

-40°F to 300°F (-40°C to 149°C)

MATERIALS:

Main component: 316L stainless steel

O-rings: Silicone (clear), platinum-cured, USP Class VI, ADCF

STERILIZATION: Autoclave

TERMINATION SIZES:

3/4" and 1-1/2" sanitary

WARNING: Pressure, temperature, chemicals, and operating environment can affect the performance of couplings. It is the customer's responsibility to test the suitability of CPC's products in their own application conditions.



cpcworldwide.com/SaniQuik

FEATURES

3/4" and 1-1/2" sanitary standard terminations

Compatible with MPC™ and MPX® Series couplings

Integral coupling adaptor

ADCF-free materials

BENEFITS

Connect to hard plumbed systems with sanitary gaskets and sanitary clamps

Quick and easy connections to industry standard plastic couplings on single-use bag and tube sets

Disconnecting coupling reduces sanitary gasket replacement

Meet BSE/TSE requirements

NOTE

Mates with MPC and MPX bodies, inserts and sealing plugs and Back-to-Back Adapters (pages 124-129).

SANIQUIK™ SERIES DIMENSIONS

CONNECTIONS - 316L stainless



DESCRIPTION	PART NO.	MATING COUPLING	SANITARY SIZE	SANITARY BORE	A	B
SILICONE SEAL USP CLASS VI	SQCC221212M	MPC Series	3/4"	3/4"	0.98 (24.9)	1.39 (35.3)
	SQCC222424M	MPC Series	1-1/2"	1-1/2"	1.98 (50.3)	1.5 (38.1)
	SQCX221212M	MPX Series	3/4"	3/4"	0.98 (24.9)	1.43 (36.3)
	SQCX222416M	MPX Series	1-1/2"	1"	1.98 (50.3)	1.50 (38.1)
	SQCX222424M	MPX Series	1-1/2"	1-1/2"	1.98 (50.3)	1.50 (38.1)

ACCESSORIES - Silicone (Clear)

DESCRIPTION	PART NO.	MATING COUPLING
PLATINUM-CURED USP CLASS VI REPLACEMENT SEALS	2260100	SQCC221212M, SQCC222424M
	2260200	SQCX221212M, SQCX222416M, SQCX222424M

All measurements are in inches (millimeters) unless otherwise noted. Tubing must meet stated inside and outside diameters.

PRODUCT DIMENSIONS

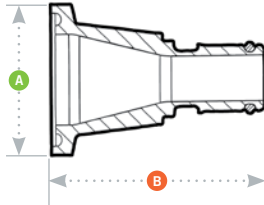

- A = Height/Diameter
- B = Total Length

NOTES



Rugged couplings and connectors made from high purity materials to transfer aggressive chemicals

Rugged couplings and connectors made from high purity materials to transfer aggressive chemicals

CPC high purity couplings and connectors are compatible with a broad variety of chemicals. With metal-free construction, Viton® seals and other critical features, high purity couplings and connectors make chemical handling cleaner and faster—one connection at a time.

- Molded, virgin materials and lubricant-free design
- Broad chemical compatibility and chemical resistance
- Cleanroom manufacturing
- Patented pressure-balanced, non-spill design
- Instant disconnects (and reconnects), even under pressure

Use CPC high purity couplings and connectors for specialized and wet process applications that require the utmost engineering design and high-quality performance.



HIGH PURITY
Couplings and Connectors

CQH SERIES CONNECTOR

The CQH Series are designed for high-purity use and feature all plastic construction. Molded, virgin materials and lubricant-free design enable use in the most demanding applications. Broad chemical compatibility and cleanroom manufacturing make them ideal for use in critical wet processes.



SPECIFICATIONS

CQH PRESSURE: 0 - 80 psig (0 - 5.5 bar)

CQH TEMPERATURE:
32°F to 225°F (0°C to 107°C)

CQH MATERIALS:

Main components: Natural, virgin polypropylene

Valve o-rings: FKM (black)

External insert o-ring:
Simriz® FFKM perfluoro (black)

Valve (wetted) and thumb latch spring:
PEEK®

Flare nuts: PVDF

Lubricants: None used

SPILLAGE/AIR INCLUSION:

~1.5 cc (ml)/disconnect (reconnect)

Note: CQH are also available with optional PPS springs and Chemraz FFKM or EPDM seals.



cpcworldwide.com/CQH

FEATURES

- 100% metal free → No risk of metal contaminants or corrosion
- High flow valve design → High flow in a compact package
- Disconnect under pressure → Speeds servicing and reduces risk of injury
- Polypropylene and PVDF → Broad chemical compatibility

BENEFITS

NOTE

See page 139 for ChemQuik Dual Containment Nut options.

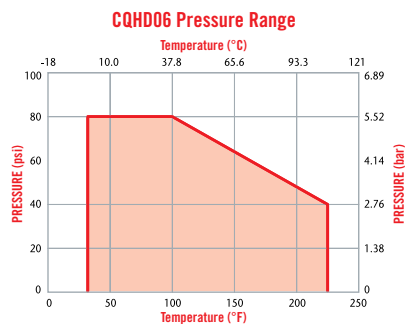
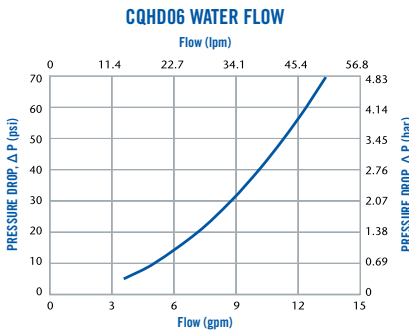

These graphs are intended to give you a general idea of the performance capabilities of each product line. The shaded area of each graph represents the operating range of the product family, i.e., upper and lower values are shown. Therefore, depending on the exact coupling configurations selected, you can reasonably expect values to fall within the shaded area.

CQH SERIES DIMENSIONS

COUPLING BODIES - Polypropylene



TERMINATION	TUBING/THREAD SIZE	TERMINATION TYPE	SHUTOFF	A	B	C
IN-LINE	3/8" OD	Flare compression	CQHD06100106	1.44 (36.6)	3.38 (85.9)	
PANEL MOUNT	3/8" Taper	Male NPT	CQHD06110206	1.82 (46.2)	2.73 (69.3)	1 (25.4)

COUPLING INSERTS - Polypropylene



TERMINATION	TUBING/THREAD SIZE	TERMINATION TYPE	SHUTOFF	A	B	C
IN-LINE	3/8" OD	Flare compression	CQHD06200106	1 (25.4)	2.55 (64.8)	1 (25.4)
	3/8" Taper	Male NPT	CQHD06200206	1.16 (29.5)	1.9 (48.3)	1 (25.4)

All measurements are in inches (millimeters) unless otherwise noted. Tubing must meet stated inside and outside diameters.

PRODUCT DIMENSIONS

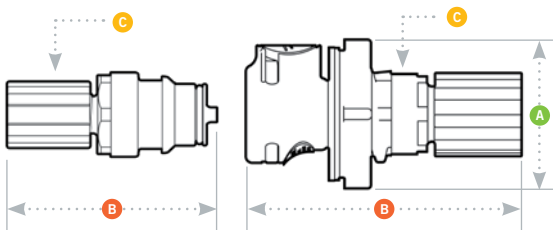

- A = Height/Diameter
- B = Total Length
- C = Hose Barb Length

PANEL DIMENSIONS

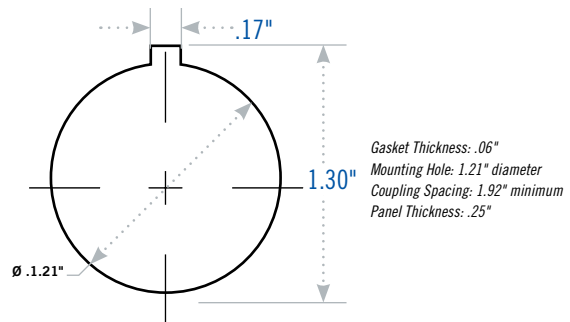

	PANEL OPENING	PANEL THICKNESS MAX.-MIN.
COUPLING BODIES	see drawing	.25 - .03

CQG SERIES CONNECTOR

The CQG06 Series high purity couplings feature our patented pressure-balanced, non-spill design. Molded virgin polypropylene and a 100% springless flow path provide broad chemical resistance and exceptionally high flow capacity, allowing instant disconnects (and reconnects), even under pressure.



SPECIFICATIONS

PRESSURE:

0 - 80 psig (0 - 5.5 bar)

TEMPERATURE:

32°F to 150°F (0°C to 66°C)

MATERIALS:

Main components:

Natural, virgin polypropylene

Seals: FKM (Simriz® FFKM optional)

Springs (non-wetted): Hastelloy® C

Flare nuts: PVDF

Lubricants: None used

Dual Containment Nut and Panel Mount Fitting:

Virgin, natural polypropylene

Flare nuts: PVDF

Panel nuts: HDPE

Panel mount o-rings: FKM

SPILLAGE/AIR INCLUSION:

<0.1 cc (ml)/disconnect (reconnect)

PANEL MOUNT: Optional adapter kit

TUBING SIZES:

3/8" to 3/4" flare; 3/8" to 3/4" NPT

WARNING: Pressure, temperature, chemicals, and operating environment can affect the performance of couplings. It is the customer's responsibility to test the suitability of CPC's products in their own application conditions.

FEATURES

Non-spill design



BENEFITS

Ultimate protection from chemicals and fumes

Pressure-balanced



Easy to reconnect at high pressure

Springless flow path design



Eliminates source of metallic contaminants

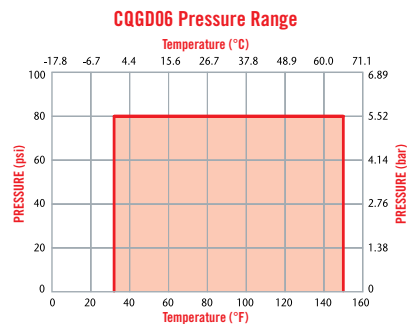
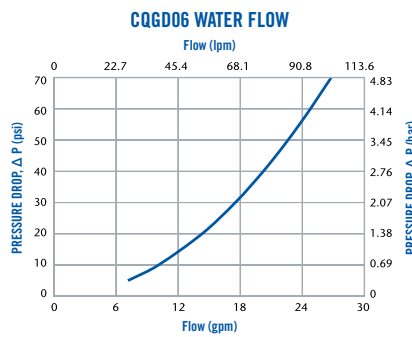

These graphs are intended to give you a general idea of the performance capabilities of each product line. The shaded area of each graph represents the operating range of the product family, i.e., upper and lower values are shown. Therefore, depending on the exact coupling configurations selected, you can reasonably expect values to fall within the shaded area.

NOTE

See page 139 for ChemQuik Dual Containment Nut options.



cpcworldwide.com/CQG

CQG SERIES DIMENSIONS

COUPLING BODIES - Polypropylene

TERMINATION	TUBING/THREAD SIZE	TERMINATION TYPE	SHUTOFF	A	B	C
IN-LINE	3/8" OD	Flare compression	CQGD06100106	1.96 (49.8)	4.21 (106.9)	1 (25.4)
	1/2" OD	Flare compression	CQGD06100108	1.96 (49.8)	4.42 (112.3)	
	3/4" OD	Flare compression	CQGD06100112	1.96 (49.8)	4.49 (114.0)	
	1/2" Taper	Male NPT	CQGD06100208	1.96 (49.8)	3.81 (96.8)	

COUPLING INSERTS - Polypropylene

TERMINATION	TUBING/THREAD SIZE	TERMINATION TYPE	SHUTOFF	A	B	C
IN-LINE	3/8" OD	Flare compression	CQGD06200106	1.62 (41.1)	4.35 (110.5)	1 (25.4)
	1/2" OD	Flare compression	CQGD06200108	1.62 (41.1)	4.45 (113.0)	1 (25.4)
	3/4" OD	Flare compression	CQGD06200112	1.62 (41.1)	4.63 (117.6)	1 (25.4)
	3/8" Taper	Male NPT	CQGD06200206‡	1.62 (41.1)	3.81 (96.8)	
	1/2" Taper	Male NPT	CQGD06200208	1.62 (41.1)	3.95 (100.3)	
	3/4" Taper	Male NPT	CQGD06200212‡	1.62 (41.1)	4.15 (105.4)	

PANEL MOUNT ADAPTOR - Polyethylene

DESCRIPTION	PART NO.
-------------	----------

Panel mount adaptor kit (fits both bodies & inserts)

All measurements are in inches (millimeters) unless otherwise noted. Tubing must meet stated inside and outside diameters.

PRODUCT DIMENSIONS

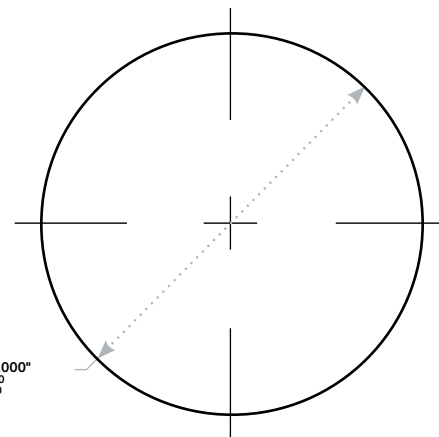
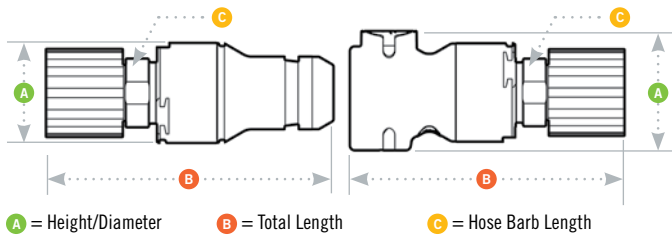

PANEL DIMENSIONS

	PANEL OPENING	PANEL THICKNESS MAX.-MIN.
COUPLING BODIES OR INSERTS	see drawing	0.50 - 0.12

CHEMQUIK® DUAL CONTAINMENT FLARE NUTS - Polypropylene



The ChemQuik® Dual Containment System is an easy way to "double contain" critical chemical lines, protecting plant and personnel in case a primary process line ruptures or "sweats". The system provides a protective secondary line to catch any fluid and routes it to a safe location.

These fittings work with any ChemQuik coupling with fine thread flare terminations or a common flare style fitting. In addition, the panel mount version can be mounted into a pump cabinet or other panel mount connection point. The primary line can then be routed from the coupling directly to a pump, connected to a ChemQuik coupling at the panel mount fitting.

The "weep port" serves to vent the area between the primary and secondary lines so that pressure cannot build up in case of a primary line rupture. The leaking fluid can then be routed to a containment vessel or to a leak detector.

FLARE NUT	DESCRIPTION
CQDCNUT0612	Dual containment nut, 3/8" OD process line x 3/4" OD secondary containment line.
	Dual containment nut, 1/2" OD process line x 3/4" OD secondary containment line.



Ideal for transferring fluids from a wide variety of rigid and flexible containers including bottles, drums, jerry cans, IBCs and bag-in-box packaging

CPC dispensing couplings and connectors save time and reduce the risk of contamination while minimizing product loss or waste when dispensing fluids. They're engineered to help improve the performance of diverse fluid dispensing applications.

Use CPC DrumQuik® dispensing systems on virtually any container including Jerry cans, drums, intermediate bulk containers (IBCs) for safe extraction of chemical or food-based fluids. Available in different sizes and materials, DrumQuik minimizes potentially dangerous exposure while protecting the fluids themselves from contamination.

Choose from an extensive selection of economical dispensing couplings and connectors for basic chemical handling, specialty high purity systems and pharmaceutical applications.

- Dispensing couplings that provide instant connection to bulk packaging systems including bag-in-box (BIB), flexible and rigid packaging styles. An ergonomic design and a large, shrouded thumb latch pad produce a coupling that is easy to grip and simple to operate.
- Dispensing quick disconnects integrated into media bottle caps make changing laboratory consumable products quicker, safer and easier.
- Puncture seal dispensing couplings provide clean and safe liquid dispensing from bag-in-box (BIB) or other types of flexible packaging. The puncture seal closure cap automatically breaks the membrane seal on the closure cap when connected.

Innovative dispensing couplings and connectors from CPC help companies reduce costs, increase worker safety and protect the environment.

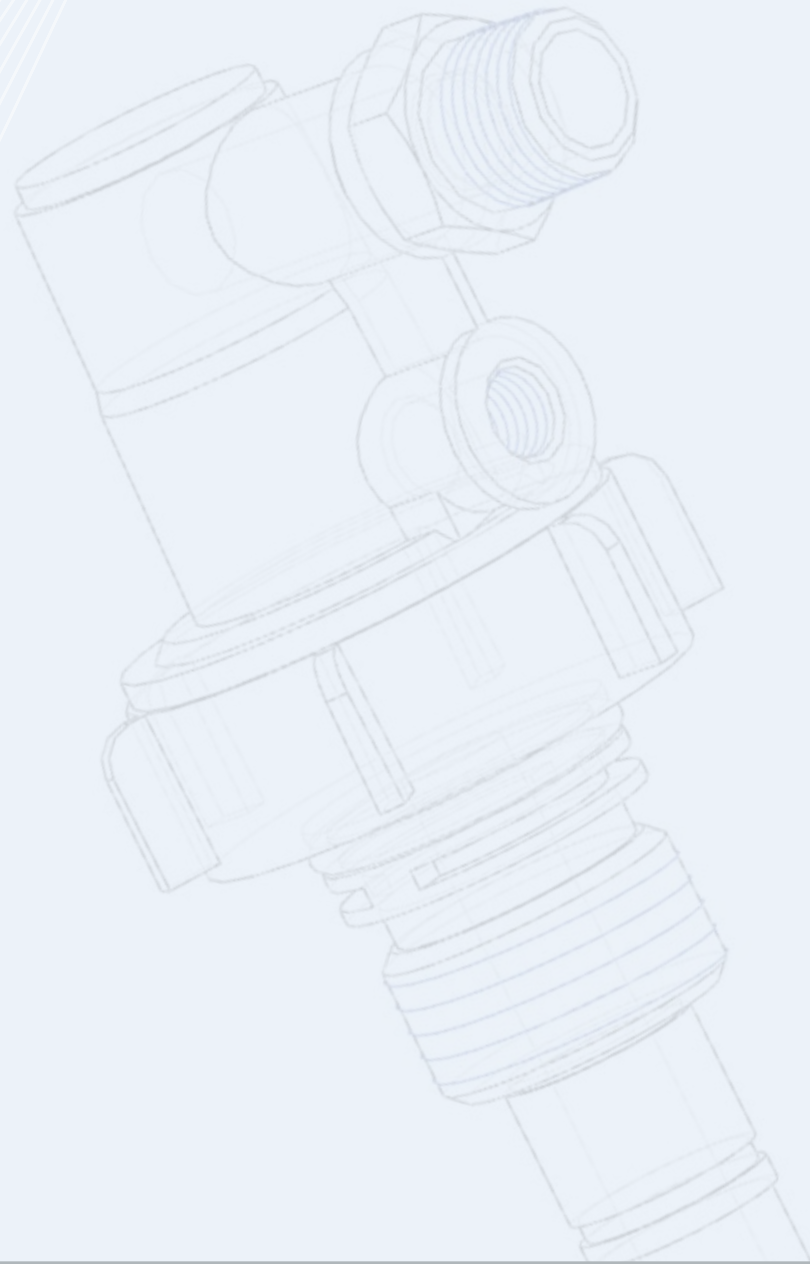

DISPENSING
Couplings and Connectors

BQ45GL SERIES CONNECTOR

BQ45GL Series Bottle Caps include a quick disconnect coupling or FitQuik® connector integrated into a cap designed for 45GL bottles. The BQ45GL series feature a hydrophobic packaging vent, polyethylene gasket and a hose barb for mounting a dip tube. Adding quick disconnects to media bottles makes changing laboratory consumable products safer and easier.



SPECIFICATIONS

TEMPERATURE:

32°F to 120°F (0°C to 49°C)

MATERIALS:

Base Cap: High density polyethylene

Gasket: Low density polyethylene

Packaging Vent: Hydrophobic PTFE

Quick Disconnects: Polypropylene, with 316 stainless steel springs and EPDM o-rings

FitQuik Connector: Polypropylene

COLOR: Blue

TUBING SIZES:

FitQuik connector: 1/4" OD

DIP tube interface: 1/4" ID

WARNING: Pressure, temperature, chemicals, and operating environment can affect the performance of couplings. It is the customer's responsibility to test the suitability of CPC products in their own application conditions.

FEATURES

Factory installed quick disconnects



Hydrophobic packaging vent



Polyethylene foam gasket



Integral hose barb



BENEFITS

Ensures cap properly seals to bottle (even without sealing rings)

Encourages proper fluid handling protocol allowing easy disconnections to replace or refill consumables in the correct location

Allows dispensing from container while preventing accidental spillage

Allows for mounting of 1/4" ID DIP tube



SCAN

cpcworldwide.com/BQ45GL

BQ45GL SERIES DIMENSIONS

BOTTLE CAPS - Polyethylene



DESCRIPTION	PART NO.	DIP TUBE SIZE	A	B	C
GL45 HDPE CAP WITH POLYETHYLENE FOAM SEALING GASKET, HYDROPHOBIC VENT AND INTEGRAL VALVED PMC12 BODY QUICK DISCONNECT INTERFACE	BQ45GL1001	1/4" ID	0.68 (17.3)	0.83 (21.1)	2.04 (51.8)
GL45 HDPE CAP WITH POLYETHYLENE FOAM SEALING GASKET, HYDROPHOBIC VENT AND INTEGRAL VALVED PMC12 INSERT QUICK DISCONNECT INTERFACE	BQ45GL2001	1/4" ID	1.08 (27.4)	0.83 (21.1)	2.04 (51.8)
GL45 HDPE CAP WITH POLYETHYLENE FOAM SEALING GASKET, HYDROPHOBIC VENT AND INTEGRAL POLYPROPYLENE ELBOW FITTING (WITH 1/4" HOSE BARB)	BQ45GL5001	1/4" ID	0.63 (16.0)	0.83 (21.1)	2.04 (51.8)

PRODUCT DIMENSIONS

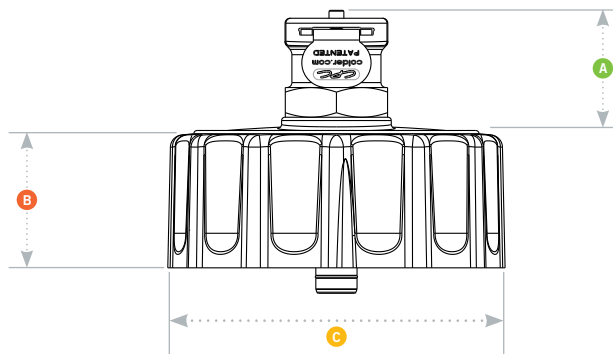

- A = Coupling
- B = Cap Height
- C = Cap Diameter

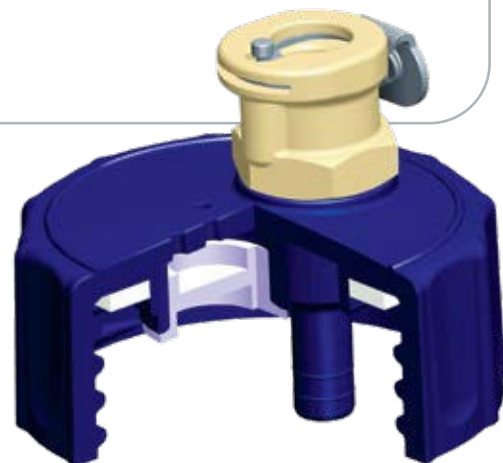

DRUMQUIK® PRO / DRUMQUIK PUR



DrumQuik® PRO and DrumQuik PUR dispensing systems are used with common pumps to create a closed transfer system for both general and high purity chemicals. These easy-to-use products meet the strict safety requirements of chemical handling applications as well as the demands of harsh operating environments. DrumQuik dispensing systems minimize chemical exposure and facilitate the delivery of chemicals from bulk transfer containers to end use applications.

For general chemical dispensing, DrumQuik PRO offers a rugged and cost-effective solution. DrumQuik PUR is a 100% metal-free, cleanroom packaged, PVDF product designed specifically for applications demanding the highest level of purity. All materials are compliant with FDA standards for food and consumables applications.



cpcworldwide.com/DrumQuikPRO

DRUMQUIK PRO & DRUMQUIK PUR WATER FLOW

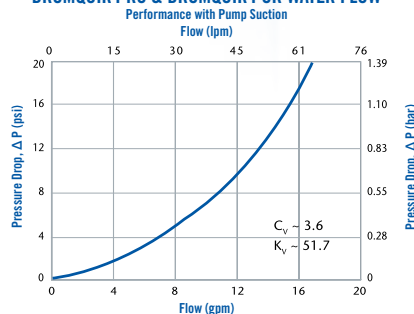

This graph characterizes the flow of the DrumQuik PRO with the coupler vent port open to the atmosphere and a pump drawing liquid out.

DRUMQUIK® DISPENSING SYSTEMS FOR SAFER CHEMICAL MANAGEMENT

Whether you're dispensing edible oils, condiments, detergents, specialty automotive fluids, or industrial chemicals, acids, caustics or solvents, DrumQuik PRO and the high purity DrumQuik PUR can make your process cleaner, faster and smarter.

- Provide the critical connection between your chemical container and the end use process
- Create a closed transfer system for workers and keep a cleaner work environment

DrumQuik solutions are available for a variety of container types providing interchangeable, reusable connections for:

- Plastic or steel drums
- Chemical packs
- IBCs or totes

DID YOU KNOW

The DrumQuik PRO dispensing system has been UN/DOT certified with many common drums and IBCs for use with hazardous chemicals per 49 CFR 173 and German BAM 11027.

NOTE

- For high purity applications DrumQuik PUR provides the assurance of compatibility with chemicals used in semiconductor and flat panel production, pharmaceutical and photovoltaic or solar cell manufacturing.
- Made from virgin materials compliant with FDA and ROHS standards.



DrumQuik® PRO and DrumQuik PUR are changing the world of chemical management with their unique closed-system design. Innovative DrumQuik systems help companies reduce costs and improve efficiencies. From basic chemical handling to specialty high purity and pharmaceutical applications, DrumQuik dispensing systems make chemical management cleaner, faster, safer and smarter.

DRUMQUIK PRO

FEATURES

- Quick connect/disconnect → Allows faster drum change-outs
- Automatic shutoff valve → Stops flow when disconnected
- Disposable drum insert → Reduces messy handling and chemical exposure
- Ported vent system for vapor management → Allows make-up air into drum or connection of blanket gas (N₂, CO₂)
- Multiple standard thread sizes → Can be used with many common steel and plastic containers

BENEFITS

DRUMQUIK PUR

FEATURES

- Quick connect/disconnect → Allows faster drum change-outs
- All plastic construction → No metallic corrosion/contamination
- Automatic shutoff valve → Stops flow when disconnected
- Cleanroom manufactured → Assures high level of purity
- Disposable drum insert → Minimizes chemical exposure & contamination

BENEFITS

SPECIFICATIONS

PRESSURE:

Uncoupled: Vacuum to 45 psig, 3.1 bar
Coupled: Vacuum to drum rating

TEMPERATURE:

Drum insert:
 -20°F to 120°F (-20°C to 49°C)
Coupler:
 HDPE, 32°F to 120°F (0°C to 49°C)
 PVDF, 0°F to 120°F (-18°C to 49°C)

MATERIALS:

Drum insert & dip-tube:
 Virgin polyethylene (HDPE)
Shipping plug:
 Virgin polyethylene (HDPE)
Coupler:
 Virgin polypropylene (DrumQuik PRO)
 Virgin PVDF (DrumQuik PUR)
Spring (coupler only):
 316 stainless steel, Hastelloy® C, virgin PEEK UHP, PPS or PTFE encapsulated 316 stainless steel (TESS)

Seals:

Coupler seals: EPDM, FKM, Simriz® UHP
 FFKM Perfluoroelastomer
Bung seal: Polyolefin, EPDM, FKM
Shipping plug seal: EPDM, FKM

Torque specifications:

2" Buttress - 20ft-lbs (27 N-m)
 BCS 56x4 - 20ft-lbs (27 N-m)
 BCS 70mm - 22ft-lbs (30 N-m)
 2" NPS (plastic drum) - 20ft-lbs (27 N-m)
 2" NPS (steel drum) - 15ft-lbs (20 N-m)
 Shipping plug - 15inch-lbs (1.7 N-m)

NOTE: The torque specifications listed above are general recommendations which may need to be adjusted + or - depending on specific application.



cpcworldwide.com/DrumQuikPUR

COUPLERS - Polypropylene

PART NUMBER	DESCRIPTION
DQPRO120312	3/4" Hose barb (EPDM seals, 316 SST spring)
DQPRO120208	1/2" Male NPT (EPDM seals, 316 SST spring)
DQPRO120208202	1/2" Male NPT (FKM seals, 316 SST spring)
DQPRO120208206	1/2" Male NPT (EPDM seals, Hastelloy C spring)
DQPRO120208207	1/2" Male NPT (FKM seals, Hastelloy C spring)
DQPRO120712	3/4" Male BSPP (EPDM seals, 316 SST spring)
DQPRO120712202	3/4" Male BSPP (FKM seals, 316 SST spring)
DQPRO120712206	3/4" Male BSPP (EPDM seals, Hastelloy C spring)
DQPRO120712207	3/4" Male BSPP (FKM seals, Hastelloy C spring)

COUPLERS - PVDF (3/4" Flare termination)

PART NUMBER	DESCRIPTION
DQPUR120112	FKM liquid contact seals, FKM vent seal, PEEK plastic spring
DQPUR120112203	Simriz® FFKM liquid contact seals, FKM vent seal, PEEK plastic spring
DQPUR120112209	Simriz FFKM liquid contact seals, FKM vent seal, PPS plastic spring
DQPUR120112210	FKM liquid contact seals, FKM vent seal, PTFE encapsulated 316 stainless steel (TESS) spring
DQPUR120112211	Simriz FFKM liquid contact seals, FKM vent seal, PTFE encapsulated 316 stainless steel (TESS) spring

DRUM INSERTS - Polyethylene (HDPE)

PART NUMBER	DESCRIPTION
DQPRO20BCS70	70mm thread, EPDM seals (70x6 and 70x5 plastic drums)
DQPRO20BCS70202	70mm thread, FKM seals (70x6 and 70x5 plastic drums)
DQPRO202BUT	2" American buttress thread, EPDM seals (No. Am. Plastic drums)
DQPRO202BUT202	2" American buttress thread, FKM seals (No. Am. Plastic drums)
DQPRO2056X4	BCS 56x4 thread, EPDM seals (European plastic drums)
DQPRO2056X4202	BCS 56x4 thread, FKM seals (European plastic drums)
DQPRO20G2NPSST	2" NPS (ISO G2) thread, EPDM seals (steel drums and IBC caps)
DQPRO20G2NPSST202	2" NPS (ISO G2) thread, FKM seals (steel drums and IBC caps)
DQPRO20G2NPSPL	2" NPS (ISO G2) thread, EPDM flat bung seal (plastic drums and IBC caps)
DQPRO20G2NPSPL202	2" NPS (ISO G2) thread, FKM flat bung seal (plastic drums and IBC caps)
DQPUR202BUT	2" American buttress thread, Polyolefin (POE) bung seal, EPDM shipping plug seal
DQPUR202BUT202	2" American buttress thread, Polyolefin (POE) bung seal, FKM shipping plug seal

DIP TUBES - Polyethylene (HDPE)

PART NUMBER	DESCRIPTION
DQPRODT0410	13.0" (330mm) long for 5 gal/25L jerry cans
DQPRODT0865	34.0" (865 mm) long for 250gal/950L IBC's
DQPRODT0985	35.5" (905mm) long for 55 gal/200L drums
DQPRODT1070	39.0" (990mm) long for 275 gal/1040L IBCs
DQPRODT1274	47.0" (1194mm) long for 330 gal/1250L IBCs
DQPURDT0985	35.5" (905mm) long for 55 gal/200L drums
DQPURDT1070	39.0" (990mm) long for 275 gal/1040L IBCs
DQPURDT1274	47.0" (1194mm) long for 330 gal/1250L IBCs

ASSEMBLED DRUM INSERTS & DIP-TUBES

PART NUMBER	DESCRIPTION
DQPUR2BUT0985	Drum insert assembly with universal dip-tube (drum), 905mm long (from sealing surface)

DRUMQUIK® PRO & PUR DISPENSING CONNECTOR SYSTEM

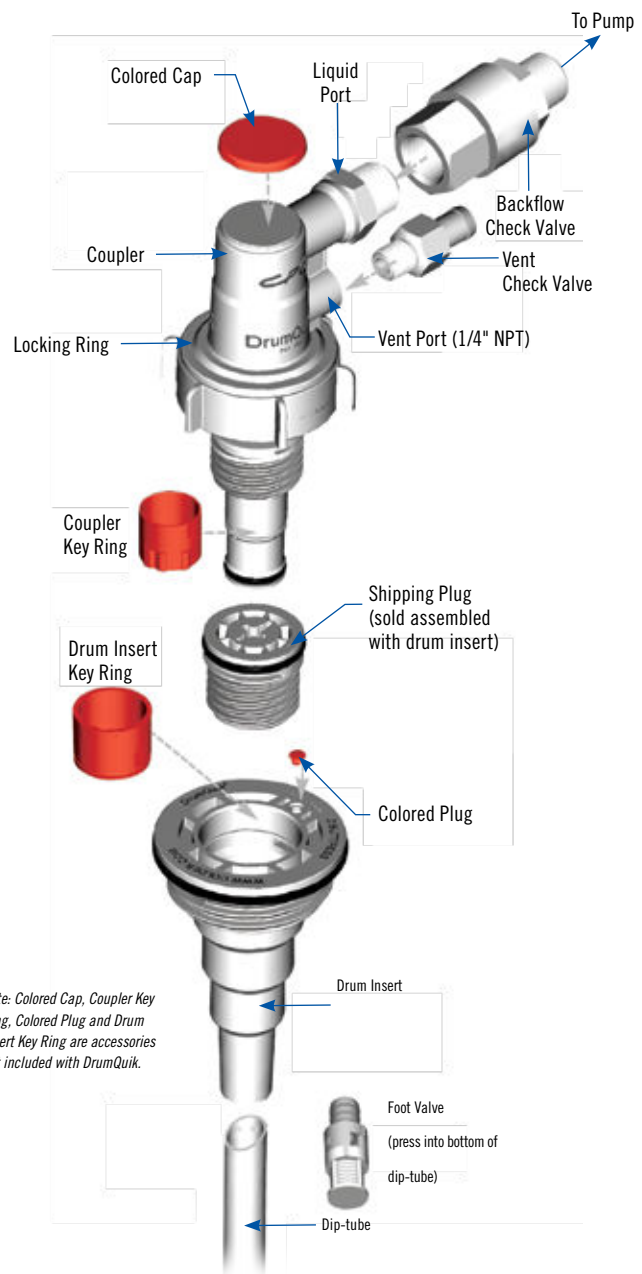

VAPOR MANAGEMENT OPTIONS:

- 1. OPEN:** Vent port left open to atmosphere
- 2. REMOTE:** Vent port routed to fume hood, scrubber or vapor recovery system
- 3. CHECKED:** Connect vent check valve to allow make-up air in without allowing fumes to escape
- 4. BLANKET GAS:** Connect a CPC quick disconnect coupling for blanket gas (N₂, CO₂)
- 5. FILTERED:** Connect vent filter

DRUMQUIK® PRO / DRUMQUIK PUR ACCESSORIES

COLOR CODING AND KEYING OPTIONS

- Colored Key Kits for Physical Coding: Polyethylene

DQPRO PART NUMBER	DQPUR PART NUMBER	DESCRIPTION
DQPROKEYCPRED01	DQPURKEYCPRED01	Key kit for coupler, red
DQPROKEYCPYEL02	DQPURKEYCPYEL02	Key kit for coupler, yellow
DQPROKEYCPGRN03	DQPURKEYCPGRN03	Key kit for coupler, green
DQPROKEYCPBRN04	DQPURKEYCPBRN04	Key kit for coupler, brown
DQPROKEYCPBLU05	DQPURKEYCPBLU05	Key kit for coupler, blue
DQPROKEYCPBLK99	DQPURKEYCPBLK99	Key kit for coupler, black
<i>Key kits for coupler include coupler key ring and cap.</i>		
DQPROKEYDIRED01	DQPURKEYDIRED01	Key kit for drum insert, red
DQPROKEYDIYEL02	DQPURKEYDIYEL02	Key kit for drum insert, yellow
DQPROKEYDIGRN03	DQPURKEYDIGRN03	Key kit for drum insert, green
DQPROKEYDIBRN04	DQPURKEYDIBRN04	Key kit for drum insert, brown
DQPROKEYDIBLU05	DQPURKEYDIBLU05	Key kit for drum insert, blue
DQPROKEYDIBLK99	DQPURKEYDIBLK99	Key kit for drum insert, black
<i>Key kits for drum insert include drum insert key ring and button plug.</i>		

COLOR CODED PARTS

- Colored Caps & Button Plugs for Visual Coding: Polyethylene

PART NUMBER	DESCRIPTION
DQPROCAPGRY00	Colored cap for coupler, gray
DQPROCAPRED01	Colored cap for coupler, red
DQPROCAPYEL02	Colored cap for coupler, yellow
DQPROCAPGRN03	Colored cap for coupler, green
DQPROCAPBLU05	Colored cap for coupler, blue
DQPROCAPBLK99	Colored cap for coupler, black
DQPROPLUGGRY00	Colored button plug for drum insert, gray
DQPROPLUGRED01	Colored button plug for drum insert, red
DQPROPLUGYEL02	Colored button plug for drum insert, yellow
DQPROPLUGGRN03	Colored button plug for drum insert, green
DQPROPLUGBLU05	Colored button plug for drum insert, blue
DQPROPLUGBLK99	Colored button plug for drum insert, black

Note: Colored caps and button plugs can be used with both DrumQuik PRO and DrumQuik PUR.

DRUMQUIK® PRO & PUR KEY KITS

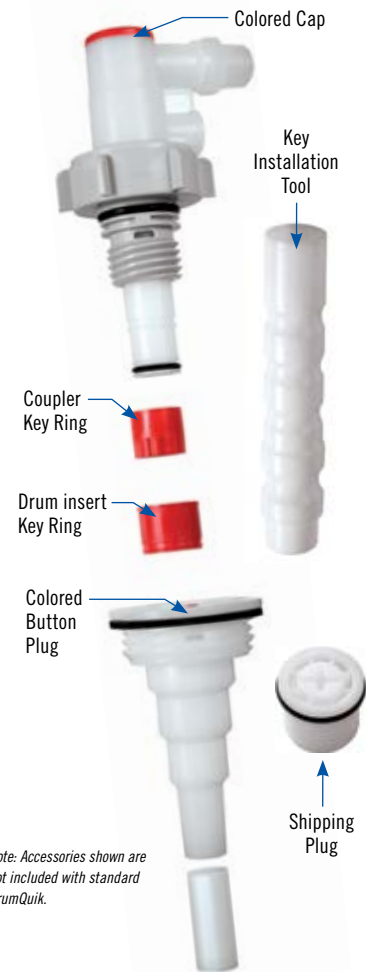

Note: Accessories shown are not included with standard DrumQuik.

COLOR CODING



ASSEMBLY

1. Fully press dip-tube into drum insert socket.



2. Place the drum insert assembly in drum.



3. Turn shipping plug counterclockwise to remove. Use a large, flat blade or #4 Phillips screwdriver.



4. Insert coupler into drum insert assembly.



5. Turn the coupler locking ring clockwise until stop is reached (approximately 2 full turns); valve is opened during this process.



DRUMQUIK® PRO / DRUMQUIK PUR ACCESSORIES

TOOLS

PART NUMBER	DESCRIPTION
2408900	Torque socket tool (blue, glass-filled nylon)
2479100	Bung wrench (aluminum)
2375600	Key installation tool for key kits (Shipping plug may also be used to install keys)

SAMPLE KITS

(Includes one coupler, one insert and one dip-tube)

PART NUMBER	DESCRIPTION
DQPRONASAMP	2" Buttress drum insert, 905mm dip-tube, 1/2 NPT coupler (EPDM O-rings, 316 SST spring in coupler)
DQPRONASAMP207	2" Buttress drum insert, 905mm dip-tube, 1/2 NPT coupler (FKM seals & Hastelloy® C spring in coupler)
DQPRONPSSTSAMP	2" NPS (ISO G2) drum insert, 905mm dip-tube, 1/2 NPT coupler (EPDM Bung O-rings, 316 SST spring in coupler)
DQPRONPSSTSAMP207	2" NPS (ISO G2) drum insert, 905mm dip-tube, 1/2 NPT coupler (FKM seals & Hastelloy® C spring in coupler)

SHIPPING PLUGS

PART NUMBER	DESCRIPTION
2007900	Shipping plug for drum insert (Does not include shipping plug o-ring)
2290100	Shipping plug o-ring, EPDM
2307200	Shipping plug o-ring, FKM
DQPURSP	Shipping Plug with EPDM seal
DQPURSP202	Shipping Plug with FKM seal

SAMPLE KITS

(Includes one coupler, one insert and one dip-tube)

PART NUMBER	DESCRIPTION
DQPURDISEALFEP	Drum insert FEP encapsulated silicone bung seal
2423400	Coupler o-ring kit, EPDM (Includes 2 o-rings)
2423500	Coupler o-ring kit, FKM (Includes 2 o-rings)
2166000	Drum insert flat gasket, 2" buttress, FDA EPDM
2165800	Drum insert o-ring, 2" NPS (ISO G2) EPDM for steel drums
2165900	Drum insert o-ring, 2" NPS (ISO G2) FKM for steel drums
2165800	Drum insert o-ring, BCS 56x4, EPDM (same as ISO G2 for steel)
2165900	Drum insert o-ring, BCS 56x4, FKM (same as ISO G2 for steel)
2525300	Drum insert flat gasket, 2" NPS (ISO G2) FKM for plastic drums
2594900	Replacement Drum Insert Seal, 2" Buttress, FDA
DQPRO70X6AD	70 X 6 Adaptor with EPDM O-Ring

SAMPLE KITS

(Includes one coupler, one insert and one dip-tube)

TETHER/DUST CAP

DQPROTETHER Tether/Dust Cap for use with DrumQuik® PRO shipping plugs and couplers (PVC, Vinyl)

COUPLER VENT PORT OPTIONS

2879800	Vent check valve, 1/2" ID x 1/4" male NPT (316 SST, Santoprene)
2879801	Vent check valve, 1/2" ID x 1/4" male NPT (Hastelloy® C, FKM)
DQPROFIL01	Air filter, coupler vent port, 1/4" male NPT (polypropylene, 70 micron)
APCD24004	Vent coupling insert, 1/4" male NPT (Acetal, 316 SST, Buna-N)
APCD17004SH	Vent coupling body with shroud, 1/4" hose barb (Acetal, 316 SST, Buna-N)
APCD17006SH	Vent coupling body with shroud, 3/8" hose barb (Acetal, 316 SST, Buna-N)
EFCD24412	Vent coupling insert, 1/4" male NPT (Polypropylene, 316 SST, EPDM)
EFCD17412	Vent coupling body, 1/4" hose barb (Polypropylene, 316 SST, EPDM)
EFCD17612	Vent coupling body, 3/8" hose barb (Polypropylene, 316 SST, EPDM)

NOTE: Parts listed above are suggested for use in the vent port, but any 1/4" NPT CPC coupling can be used for blanket gas applications (see page 146)

BACKFLOW PREVENTION OPTIONS - POLYPROPYLENE

2478900	Check valve for couplers, 1/2" female NPT x 1/2" male NPT (EPDM, 302 SST)
2478901	Check valve for couplers, 1/2" female NPT x 1/2" male NPT (FKM, 302 SST)
2478902	Check valve for couplers, 1/2" female NPT x 1/2" male NPT (EPDM, Hastelloy C)
2478903	Check valve for couplers, 1/2" female NPT x 1/2" male NPT (FKM, Hastelloy C)
2479000	Foot valve for dip-tube, 1/2" hose barb (EPDM, 316 SST)
2479001	Foot valve for dip-tube, 1/2" hose barb (FKM, 316 SST)
2479002	Foot valve for dip-tube, 1/2" hose barb (EPDM, Hastelloy C)
2479003	Foot valve for dip-tube, 1/2" hose barb (FKM, Hastelloy C)

NOTE: CPC distributes the above check valves and foot valves. These valves are not produced by CPC and CPC makes no claims or warranty regarding suitability for use in specific applications.

COUPLER LIQUID PORT FITTINGS - POLYPROPYLENE

2402600	1/2" female NPT x 3/8" OD compression
2402700	1/2" female NPT x 1/2" OD compression
2402800	1/2" female NPT x 5/8" OD compression
2402900	1/2" female NPT x 3/8" ID hose barb
2403000	1/2" female NPT x 1/2" ID hose barb
2403100	1/2" female NPT x 3/4" ID hose barb

DQPUR ACCESSORY FITTINGS

DQPUR FR1208	Flare Reducer, PFA, 3/4" Female Flare x 1/2" Male Flare
DQPUR FI1216	Flare Increaser, PFA, 3/4" Female Flare x 1" Male Flare
DQPUR TFMC1208	Female flare x male connector, PFA, 3/4" Female Flare x 1/2" Male NPT
DQPUR SE0808	Sweep Elbow, PFA, 1/2" Female Flare x 1/2" Male Flare

NOTE

Use shipping plug or key installation tool to install keys. Orient ring with lugs down and drum insert key ring with shoulder up.



SCAN

cpcworldwide.com/
DrumQuikPRO-accessories



SCAN

cpcworldwide.com/
DrumQuikPUR-accessories

Torque Tool



Bung Wrench

Refer to specifications for torque requirements (page 145)



Backflow Check and Foot Valves

Prevents liquid from draining back into drum when pump is off



Coupler Liquid Port Fittings



Shipping Plug



Key
Installation
Tool



Universal 3-Port Drum Adaptor Kit
(shown with HFC12 and NS4)



Universal Drum Adaptor Kit (shown
with NSH Series)

DRUMQUIK® PRO / DRUMQUIK PUR ACCESSORIES

DRUMQUIK® 3-PORT UDA KIT - Polypropylene

The 3-Port UDA features a 3/4" male NPT thread that mates with common containers, bung plugs and caps. The adaptor ports enable simultaneous chemical extraction, venting or application of blanket gas. In addition, the third port can be used to recirculate priming chemical to the container in metering pump applications.

Optional system components including foot valves, air filters and vent check valves are also available. For your convenience, CPC offers a variety of drum adaptor plugs to facilitate easy drum connections. (See plugs and caps on page 148.)

PART NUMBER	DESCRIPTION
DQUA3PKIT	3-port adaptor, EPDM seal, locking nut, 35.5" (905mm) dip-tube, 1/2" x 3/8" & 1/2" x 1/4" reducer bushings and 1/4" & 3/8" NPT plugs
DQUA3PKIT202	3-port adaptor, FKM seal, locking nut, 35.5" (905mm) dip-tube, 1/2" x 3/8" & 1/2" x 1/4" reducer bushings and 1/4" & 3/8" NPT plugs
DQUA3P	3-port adaptor bulk packaged (1/2" female NPT liquid outlet port, 3/8" & 1/4" NPT vent/recirculation ports)
DQUA3PNUT	Locking nut for the 3-port adaptor
2717000	EPDM seal for the 3-port adaptor
2717100	FKM seal for the 3-port adaptor
2621400	Pipe plug, black polypropylene, 3/8" male NPT

Use with PLC, Non-Spill, EFC and ChemQuik Series couplings.

NOTE

Can be used with many standard CPC quick disconnect couplings and standard bung plugs and bottle caps.

DRUMQUIK PLUGS AND CAPS

For your convenience, CPC offers several sizes of common bung plugs and caps that have the internal 3/4" female NPS thread, into which the DrumQuik Universal Drum Adaptors/ ChemQuik couplings are threaded.

PART NUMBER	DESCRIPTION
DQMBUNGPP2BUT12	Bung closure, polypropylene, EPDM o-ring, 2" buttress x 3/4" female NPS
DQMBUNGPP2NPS12	Bung closure, polypropylene, EPDM o-ring, 2" NPS x 3/4" female NPS
DQMCAPPP70mm	Cap closure, polypropylene, EPDM o-ring, 70mm x 3/4" female NPS
DQMCAPPP63MM	Cap closure, polypropylene, EPDM o-ring, 63mm, 3/4" female NPS

All measurements are in inches (millimeters) unless otherwise noted. Tubing must meet stated inside and outside diameters. NOTE: The DQ UDA kits are designed to work with CPC couplings that have 3/4" NPT male terminations. The DQ UDA 3-Port kits are designed to work with a 1/2" NPT male on the liquid port and a 1/4" NPT male on the vent port. A 1/2" male NPT to 1/4" female NPT reducer bushing may be required to accommodate smaller NS4, PLC and PMC Series couplings. BottleQuik features two 3/8" female NPT ports. NOTE: DrumQuik Adaptors are intended for end-use applications not requiring compliance with UN/DOT standards for use in transportation of hazardous materials.



SCAN

[cpcworldwide.com/
DrumQuikPRO-accessories](http://cpcworldwide.com/DrumQuikPRO-accessories)



SCAN

[cpcworldwide.com/
DrumQuikPUR-accessories](http://cpcworldwide.com/DrumQuikPUR-accessories)



Type A

For use with closure plugs with a 3/4" NPS center port.

Type B

For use with closure plugs with a 1-3/8" buttress center port.



3/4" NPT inner port incorporates a face seal to assure a leak-free connection.



DQ UDA kits can be used with a wide range of closures.

UDC SERIES CONNECTOR

The 3/8" flow Universal Dispensing Coupler (UDC) provides a universal connection to a 38mm threaded or snap-in fitment neck. Make instant connections to bulk packaging systems including bag-in-box (BIB), flexible and rigid packaging styles. Automatic flush face valves minimize costly or dangerous spillage. An ergonomic design and a large, shrouded thumb latch produce a coupling that is easy to grip and simple to operate. The UDC Series is also available with optional RFID (Radio Frequency Identification) capability (see page 117).

SPECIFICATIONS

PRESSURE:

20" Hg vacuum to 15 psi, 1.0 bar (body only)

TEMPERATURE:

32°F to 160°F (0°C to 71°C)

MATERIALS:

Main body components and valves:

Polypropylene

Springs:

Body: 316 stainless steel

Cap: 302 stainless steel

UDC caps: Acetal, polypropylene

O-rings (food grade):

UDC: EPDM, silicone, Buna-N

iUDC: EPDM, silicone

CIP adapter: Acetal

COLOR: Light gray with dark gray latch

CLOSURE SIZE:

SP-400 thread/38mm snap-in

TUBING SIZES:

3/8" to 3/4" ID, 9.5mm to 19.0mm ID



SCAN

cpcworldwide.com/UDC

FEATURES

Universal 38mm cap	→	Fits industry standard fitment necks
Flush face/non-spill valves	→	Minimize spillage
Integral terminations	→	Fewer leak points, shorter assemblies, faster installations
Shrouded thumb latch	→	Protects against accidental disconnects
RFID technology (iUDC only)	→	Helps maintain warranty, integrity, brand protection

BENEFITS



NSF OPTION AVAILABLE

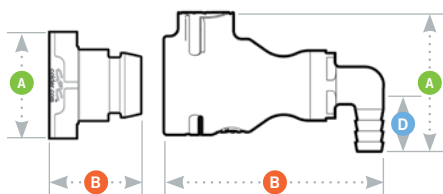

This product has an NSF compatible product for food applications. Our food-grade couplings are superior to general fittings for fluid control because they incorporate built-in shutoff valves, enabling tubing to be disconnected without having to turn off the water supply. Scan the QR code to be taken to the NSF specific product web page.





- A = Height/Diameter
- B = Total Length
- D = Elbow Radial Length

UDC SERIES DIMENSIONS

COUPLING BODIES - Polypropylene

TERMINATION	TUBING SIZE	SILICONE O-RING	BUNA-N O-RING	EPDM O-RING	A	B	D
 IN-LINE HOSE BARB	3/8" ID	99000	98400	98500	1.73 (43.9)	3.06 (77.7)	
	1/2" ID	95600	97600	95300	1.73 (43.9)	3.06 (77.7)	
	5/8" ID	99100	97900	98100	1.73 (43.9)	3.2 (81.3)	
	3/4" ID	99200	98600	98700	1.73 (43.9)	3.21 (81.5)	
 ELBOW HOSE BARB	3/8" ID	99300	97800	99400	1.73 (43.9)	3.25 (82.6)	0.93 (23.6)
	1/2" ID	95400	97700	95100	1.73 (43.9)	3.25 (82.6)	0.93 (23.6)



CAPS - Acetal / Polypropylene

TERMINATION	DESCRIPTION	SILICONE O-RING	BUNA-N O-RING	EPDM O-RING	A	B	D
 ACETAL THREAD-ON 38MM VALVED	Without thread seal	95800	96400	97400	1.7 (43.2)	1.47 (37.3)	0.93 (23.6)
	With thread seal	95801	96401	97401	1.7 (43.2)	1.47 (37.3)	0.93 (23.6)
 POLYPROPYLENE SNAP-IN 38MM VALVED		9461300		9500000	1.15 (29.2)	1.77 (45.0)	
	Note: Snap-in closure designed to fit Scholle 900 bag necks.						
 POLYPROPYLENE THREAD-ON 38MM VALVED	With thread seal			9462000	1.7 (43.2)	1.48 (37.6)	



CLEAN-IN-PLACE (CIP) ADAPTER - Acetal

TERMINATION	DESCRIPTION	PART NO.	A	B	D
 IN-LINE	1/2" HB (no o-ring)	96000	1.15 (29.2)	1.56 (39.6)	

COUPLING READERS - Polypropylene

TERMINATION	TUBING SIZE	METRIC EQ.	SHUTOFF (RS-232)	SHUTOFF (USB)	A	B	D
 IN-LINE HOSE BARB	1/4" ID	6.4mm ID	iUDCDR1700400	iUDCDR1700401	2 (50.8)	3.49 (88.6)	
	3/8" ID	9.5mm ID	iUDCDR1700600	iUDCDR1700601	2 (50.8)	3.49 (88.6)	
	1/2" ID	12.7mm ID	iUDCDR1700800	iUDCDR1700801	2 (50.8)	3.49 (88.6)	
	5/8" ID	15.9mm ID	iUDCDR1701000		2 (50.8)	3.49 (88.6)	
	3/4" ID	19mm ID	iUDCDR1701200		2 (50.8)	3.49 (88.6)	
 PANEL MOUNT HOSE BARB	1/4" ID	6.4mm ID	iUDCDR1600400	iUDCDR1600401	Refer to		
	3/8" ID	9.5mm ID	iUDCDR1600600	iUDCDR1600601	cpcworldwide.com		
	1/2" ID	12.7mm ID	iUDCDR1600800	iUDCDR1600801	for dimensions		

CAPS - Acetal / Polypropylene

TERMINATION	DESCRIPTION	METRIC EQ.	SHUTOFF	SHUTOFF	A	B	D
 ACETAL THREAD-ON 38MM VALVED	Without thread seal	38mm	iUDCDTCN3803		1.7 (43.2)	1.47 (37.3)	
	With thread seal	38mm	iUDCDTCS3803		1.7 (43.2)	1.47 (37.3)	
 POLYPROPYLENE SNAP-IN 38MM VALVED		38mm	iUDCDTSN0000		1.76 (44.7)	1.77 (45.0)	
 POLYPROPYLENE THREAD-ON 38MM VALVED	Without thread seal	38mm	iUDCDTCN3800		1.48 (37.6)	1.48 (37.6)	
	With thread seal	38mm	iUDCDTCS3800		1.48 (37.6)		

All measurements are in inches (millimeters) unless otherwise noted. Tubing must meet stated inside and outside diameters. Couplings are pictured with valves unless otherwise noted.

PUNCTURE SEAL SERIES CONNECTOR

The 1/4" flow Puncture Seal dispensing system provides clean and safe liquid dispensing from bag-in-box (BIB) or other types of flexible packaging. The system consists of a Puncture Seal closure cap and a specially designed quick disconnect coupling body. The closure makes a positive thread or snap-in seal with a 38mm fitment neck. The Puncture Seal coupling body automatically breaks the membrane seal on the closure cap when connected. To switch to a new container, simply depress the CPC thumb latch to disconnect the system and then connect the Puncture Seal coupling body to a fresh container.

SPECIFICATIONS

PRESSURE:

120 psi, 8.3 bar (coupling body)

TEMPERATURE:

32°F to 160°F (0°C to 71°C)

MATERIALS:

Main components and valves: Polypropylene

38mm closure: Polyethylene (LDPE)

Thumb latch: Stainless steel

Valve spring: 316 stainless steel

External spring and pin: Stainless steel

O-rings: EPDM

CLOSURE SIZE: SP-400 38mm

TUBING SIZES:

1/4" and 3/8" ID, 6.4mm and 9.5mm ID



SCAN

cpcworldwide.com/Puncture-Seal

FEATURES

- Puncture Seal coupling → Easily breaks the Puncture Seal membrane
- Polypropylene and polyethylene materials → Greater chemical resistance
- Puncture Seal membrane → Eliminates shipping caps and o-rings
- CPC thumb latch → One-hand connection and disconnection

BENEFITS



NSF OPTION AVAILABLE

This product has an NSF compatible product for food applications. Our food-grade couplings are superior to general fittings for fluid control because they incorporate built-in shutoff valves, enabling tubing to be disconnected without having to turn off the water supply. Scan the QR code to be taken to the NSF specific product web page.



PUNCTURE SEAL SERIES DIMENSIONS

COUPLING BODIES - Polypropylene



TERMINATION	TUBING SIZE	METRIC EQ.	STRAIGHT THRU	SHUTOFF	LENGTH
IN-LINE HOSE BARB	1/4" ID	6.4mm ID	PS1700412	PSD1700412	1.95 (49.5)
	3/8" ID	9.5 mm ID		PSD1700612	1.95 (49.5)

CLOSURE - Polyethylene



TERMINATION	PART NO.	LENGTH	HEIGHT
THREAD-ON 38MM VALVED	PSC38mm	1.7 (43.2)	1.12 (28.4)
SNAP-IN 38MM VALVED	496200	1.88 (47.8)	1.62 (41.1)

Note: Snap-in closure designed to fit Scholle 900 bag necks.

DID YOU KNOW

CPC's Puncture Seal closures can be used to dispense virtually any liquid from flexible packages.

The Puncture Seal makes transporting and dispensing cleaning concentrates, dry cleaning chemicals and soaps cleaner and safer. Printing inks, photo developers and dying agents can also be dispensed quickly and easily, without messy drips or spills. The Puncture Seal can also be used with beverage and condiment dispensing systems, just look for the NSF-listed part numbers.

CLOSURE DETAIL

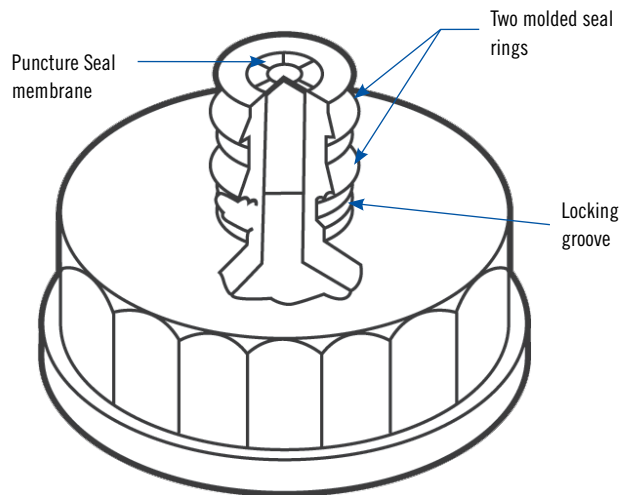



Small-bore connectors designed to connect tubing and equipment for the transfer of fluids and gases

CPC fittings, luers and blood pressure connectors are available in a variety of materials and configurations, making them extremely versatile for limited use or disposable applications. Luer connectors from CPC are the preferred choice for high quality, precision-molded fluid components and small flow applications.

Check out the broad range of blood pressure connectors that feature precise hose barbs and thread forms. No matter what type of connector needed—bayonet, SMC, quarter turn, screw threads, multi-line there is a connector for varying cuff requirements.



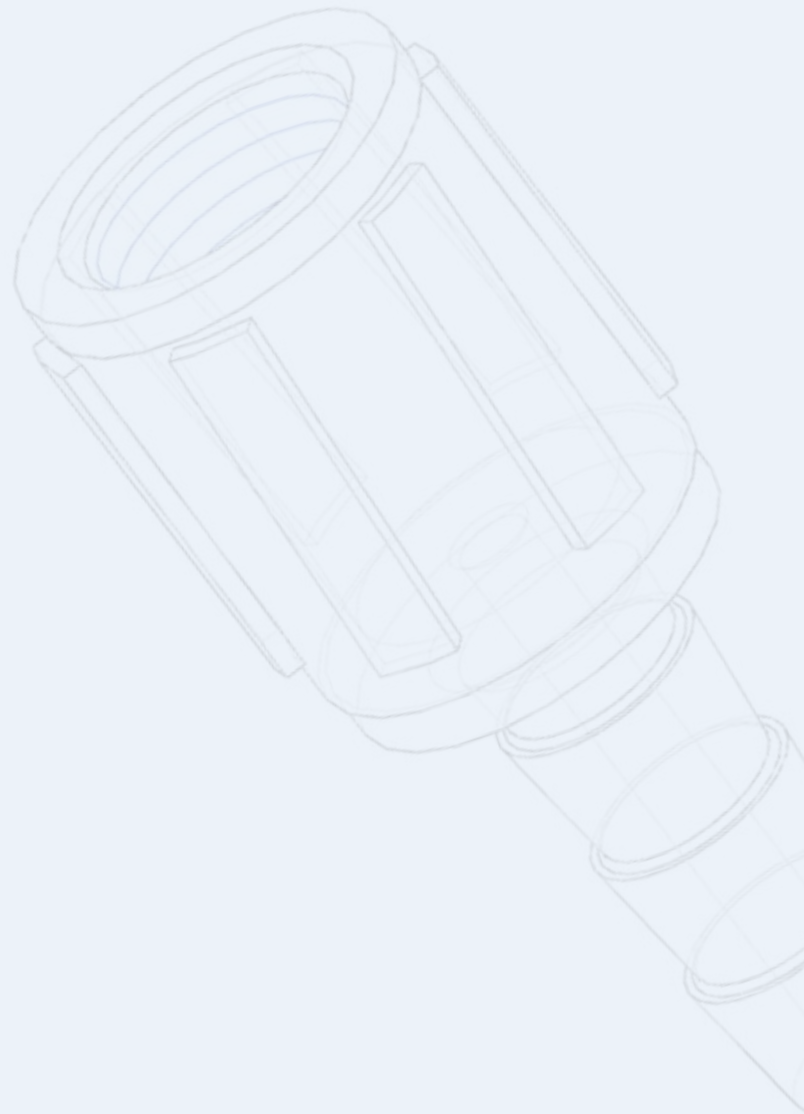



Get the right fit, every time. CPC fittings, luers and blood pressure connectors are engineered to provide a seamless fluid handling solution.





***FITQUIK[®] FITTINGS, LUERS
AND BLOOD PRESSURE
Connectors***

TUBE TO TUBE FITTINGS

TUBE TO TUBE FITTINGS - STRAIGHT

PART NO.	DESCRIPTION
 HS2	Polypropylene Straight Fitting, 1/16" Hose Barbs
HS230	White Nylon Straight Fitting, 1/16" Hose Barbs
HS231	Black Nylon Straight Fitting, 1/16" Hose Barbs
HS270	PVDF Straight Fitting, 1/16" Hose Barb
HS291	Purple Tint Polycarbonate Straight Fitting, 1/16" Hose Barbs
 HS3	Polypropylene Straight Fitting, 3/32" Hose Barbs
HS330	White Nylon Straight Fitting, 3/32" Hose Barbs
HS331	Black Nylon Straight Fitting, 3/32" Hose Barbs
HS370	PVDF Straight Fitting, 3/32" Hose Barb
HS391	Purple Tint Polycarbonate Straight Fitting, 3/32" Hose Barbs
 HS4	Polypropylene Straight Fitting, 1/8" Hose Barbs
HS430	White Nylon Straight Fitting, 1/8" Hose Barbs
HS431	Black Nylon Straight Fitting, 1/8" Hose Barbs
HS470	PVDF Straight Fitting, 1/8" Hose Barb
HS491	Purple Tint Polycarbonate Straight Fitting, 1/8" Hose Barbs
 HS5	Polypropylene Straight Fitting, 5/32" Hose Barbs
HS530	White Nylon Straight Fitting, 5/32" Hose Barbs
HS531	Black Nylon Straight Fitting, 5/32" Hose Barbs
HS570	PVDF Straight Fitting, 5/32" Hose Barb
HS591	Purple Tint Polycarbonate Straight Fitting, 5/32" Hose Barbs
 HS6	Polypropylene Straight Fitting, 3/16" Hose Barbs
HS630	White Nylon Straight Fitting, 3/16" Hose Barbs
HS631	Black Nylon Straight Fitting, 3/16" Hose Barbs
HS670	PVDF Straight Fitting, 3/16" Hose Barb
HS691	Purple Tint Polycarbonate Straight Fitting, 3/16" Hose Barbs
 HS8	Polypropylene Straight Fitting, 1/4" Hose Barbs
HS830	White Nylon Straight Fitting, 1/4" Hose Barbs
HS831	Black Nylon Straight Fitting, 1/4" Hose Barbs
HS870	PVDF Straight Fitting, 1/4" Hose Barb
HS891	Purple Tint Polycarbonate Straight Fitting, 1/4" Hose Barbs
 HS12	Polypropylene Straight Fitting, 3/8" Hose Barbs
HS1230	White Nylon Straight Fitting, 3/8" Hose Barbs
HS1231	Black Nylon Straight Fitting, 3/8" Hose Barbs
HS1270	PVDF Straight Fitting, 3/8" Hose Barbs

TUBE TO TUBE FITTINGS - ELBOW

PART NO.	DESCRIPTION
 HE2	Polypropylene Elbow Fitting, 1/16" Hose Barbs
HE230	White Nylon Elbow Fitting, 1/16" Hose Barbs
HE231	Black Nylon Elbow Fitting, 1/16" Hose Barbs
HE270	PVDF Elbow Fitting, 1/16" Hose Barbs
HE291	Purple Tint Polycarbonate Elbow Fitting, 1/16" Hose Barbs
 HE3	Polypropylene Elbow Fitting, 3/32" Hose Barbs
HE330	White Nylon Elbow Fitting, 3/32" Hose Barbs
HE331	Black Nylon Elbow Fitting, 3/32" Hose Barbs
HE370	PVDF Elbow Fitting, 3/32" Hose Barbs
HE391	Purple Tint Polycarbonate Elbow Fitting, 3/32" Hose Barbs





TUBE TO TUBE FITTINGS - ELBOW (CONT.)

PART NO.	DESCRIPTION
 HE4	Polypropylene Elbow Fitting, 1/8" Hose Barbs
HE430	White Nylon Elbow Fitting, 1/8" Hose Barbs
HE431	Black Nylon Elbow Fitting, 1/8" Hose Barbs
HE470	PVDF Elbow Fitting, 1/8" Hose Barbs
HE491	Purple Tint Polycarbonate Elbow Fitting, 1/8" Hose Barbs
 HE5	Polypropylene Elbow Fitting, 5/32" Hose Barbs
HE530	White Nylon Elbow Fitting, 5/32" Hose Barbs
HE531	Black Nylon Elbow Fitting, 5/32" Hose Barbs
HE570	PVDF Elbow Fitting, 5/32" Hose Barbs
HE591	Purple Tint Polycarbonate Elbow Fitting, 5/32" Hose Barbs
 HE6	Polypropylene Elbow Fitting, 3/16" Hose Barbs
HE630	White Nylon Elbow Fitting, 3/16" Hose Barbs
HE631	Black Nylon Elbow Fitting, 3/16" Hose Barbs
HE670	PVDF Elbow Fitting, 3/16" Hose Barbs
HE691	Purple Tint Polycarbonate Elbow Fitting, 3/16" Hose Barbs
 HE8	Polypropylene Elbow Fitting, 1/4" Hose Barbs
HE830	White Nylon Elbow Fitting, 1/4" Hose Barbs
HE831	Black Nylon Elbow Fitting, 1/4" Hose Barbs
HE870	PVDF Elbow Fitting, 1/4" Hose Barbs
HE891	Purple Tint Polycarbonate Elbow Fitting, 1/4" Hose Barbs
 HE12	Polypropylene Elbow Fitting, 3/8" Hose Barbs
HE1230	White Nylon Elbow Fitting, 3/8" Hose Barbs
HE1231	Black Nylon Elbow Fitting, 3/8" Hose Barbs
HE1270	PVDF Elbow Fitting, 3/8" Hose Barbs

NOTE

FitQuik polycarbonate fittings are compatible with autoclave sterilization. See sterilization guide on page 168.

TUBE TO TUBE FITTINGS - TEE

PART NO.	DESCRIPTION
 HT2	Polypropylene Tee Fitting, 1/16" Hose Barbs
HT230	White Nylon Tee Fitting, 1/16" Hose Barbs
HT231	Black Nylon Tee Fitting, 1/16" Hose Barbs
HT270	PVDF Tee Fitting, 1/16" Hose Barbs
HT291	Purple Tint Polycarbonate Tee Fitting, 1/16" Hose Barbs
 HT3	Polypropylene Tee Fitting, 3/32" Hose Barbs
HT330	White Nylon Tee Fitting, 3/32" Hose Barbs
HT331	Black Nylon Tee Fitting, 3/32" Hose Barbs
HT370	PVDF Tee Fitting, 3/32" Hose Barbs
HT391	Purple Tint Polycarbonate Tee Fitting, 3/32" Hose Barbs
 HT4	Polypropylene Tee Fitting, 1/8" Hose Barbs
HT430	White Nylon Tee Fitting, 1/8" Hose Barbs
HT431	Black Nylon Tee Fitting, 1/8" Hose Barbs
HT470	PVDF Tee Fitting, 1/8" Hose Barbs
HT491	Purple Tint Polycarbonate Tee Fitting, 1/8" Hose Barbs
 HT5	Polypropylene Tee Fitting, 5/32" Hose Barbs
HT530	White Nylon Tee Fitting, 5/32" Hose Barbs
HT531	Black Nylon Tee Fitting, 5/32" Hose Barbs
HT570	PVDF Tee Fitting, 5/32" Hose Barbs
HT591	Purple Tint Polycarbonate Tee Fitting, 5/32" Hose Barbs

TUBE TO TUBE FITTINGS - TEE (CONT.)

	PART NO.	DESCRIPTION
	HT6	Polypropylene Tee Fitting, 3/16" Hose Barbs
	HT630	White Nylon Tee Fitting, 3/16" Hose Barbs
	HT631	Black Nylon Tee Fitting, 3/16" Hose Barbs
	HT670	PVDF Tee Fitting, 3/16" Hose Barbs
	HT691	Purple Tint Polycarbonate Tee Fitting, 3/16" Hose Barbs
	HT8	Polypropylene Tee Fitting, 1/4" Hose Barbs
	HT830	White Nylon Tee Fitting, 1/4" Hose Barbs
	HT831	Black Nylon Tee Fitting, 1/4" Hose Barbs
	HT870	PVDF Tee Fitting, 1/4" Hose Barbs
	HT891	Purple Tint Polycarbonate Tee Fitting, 1/4" Hose Barbs
	HT12	Polypropylene Tee Fitting, 3/8" Hose Barbs
	HT1230	White Nylon Tee Fitting, 3/8" Hose Barbs
	HT1231	Black Nylon Tee Fitting, 3/8" Hose Barbs
	HT1270	PVDF Tee Fitting, 3/8" Hose Barbs

TUBE TO TUBE FITTINGS - Y

	PART NO.	DESCRIPTION
	HY2	Polypropylene Y Fitting, 1/16" Hose Barbs
	HY230	White Nylon Y Fitting, 1/16" Hose Barbs
	HY231	Black Nylon Y Fitting, 1/16" Hose Barbs
	HY270	PVDF Y Fitting, 1/16" Hose Barbs
	HY291	Purple Tint Polycarbonate Y Fitting, 1/16" Hose Barbs
	HY3	Polypropylene Y Fitting, 3/32" Hose Barbs
	HY330	White Nylon Y Fitting, 3/32" Hose Barbs
	HY331	Black Nylon Y Fitting, 3/32" Hose Barbs
	HY370	PVDF Y Fitting, 3/32" Hose Barbs
	HY391	Purple Tint Polycarbonate Y Fitting, 3/32" Hose Barbs
	HY4	Polypropylene Y Fitting, 1/8" Hose Barbs
	HY430	White Nylon Y Fitting, 1/8" Hose Barbs
	HY431	Black Nylon Y Fitting, 1/8" Hose Barbs
	HY470	PVDF Y Fitting, 1/8" Hose Barbs
	HY491	Purple Tint Polycarbonate Y Fitting, 1/8" Hose Barbs
	HY5	Polypropylene Y Fitting, 5/32" Hose Barbs
	HY530	White Nylon Y Fitting, 5/32" Hose Barbs
	HY531	Black Nylon Y Fitting, 5/32" Hose Barbs
	HY570	PVDF Y Fitting, 5/32" Hose Barbs
	HY591	Purple Tint Polycarbonate Y Fitting, 5/32" Hose Barbs
	HY6	Polypropylene Y Fitting, 3/16" Hose Barbs
	HY630	White Nylon Y Fitting, 3/16" Hose Barbs
	HY631	Black Nylon Y Fitting, 3/16" Hose Barbs
	HY670	PVDF Y Fitting, 3/16" Hose Barbs
	HY691	Purple Tint Polycarbonate Y Fitting, 3/16" Hose Barbs
	HY8	Polypropylene Y Fitting, 1/4" Hose Barbs
	HY830	White Nylon Y Fitting, 1/4" Hose Barbs
	HY831	Black Nylon Y Fitting, 1/4" Hose Barbs
	HY870	PVDF Y Fitting, 1/4" Hose Barbs
	HY891	Purple Tint Polycarbonate Y Fitting, 1/4" Hose Barbs
	HY12	Polypropylene Y Fitting, 3/8" Hose Barbs
	HY1230	White Nylon Y Fitting, 3/8" Hose Barbs
	HY1231	Black Nylon Y Fitting, 3/8" Hose Barbs
	HY1270	PVDF Y Fitting, 3/8" Hose Barbs

TUBE TO TUBE FITTINGS - STRAIGHT REDUCER

	PART NO.	DESCRIPTION
	HSR32	Polypropylene Reducer Fitting, 3/32" to 1/16" Hose Barb
	HSR3230	White Nylon Reducer Fitting, 3/32" to 1/16" Hose Barb
	HSR3231	Black Nylon Reducer Fitting, 3/32" to 1/16" Hose Barb
	HSR3270	PVDF Straight Reducer Fitting, 3/32" to 1/16" Hose Barb
	HSR3291	Purple Tint Polycarbonate Reducer Fitting, 3/32" to 1/16" Hose Barb
	HSR42	Polypropylene Reducer Fitting, 1/8" to 1/16" Hose Barb
	HSR4230	White Nylon Reducer Fitting, 1/8" to 1/16" Hose Barb
	HSR4231	Black Nylon Reducer Fitting, 1/8" to 1/16" Hose Barb
	HSR4270	PVDF Straight Reducer Fitting, 1/8" to 1/16" Hose Barb
	HSR4291	Purple Tint Polycarbonate Reducer Fitting, 1/8" to 1/16" Hose Barb
	HSR43	Polypropylene Reducer Fitting, 1/8" to 3/32" Hose Barb
	HSR4330	White Nylon Reducer Fitting, 1/8" to 3/32" Hose Barb
	HSR4331	Black Nylon Reducer Fitting, 1/8" to 3/32" Hose Barb
	HSR4370	PVDF Straight Reducer Fitting, 1/8" to 3/32" Hose Barb
	HSR4391	Purple Tint Polycarbonate Reducer Fitting, 1/8" to 3/32" Hose Barb
	HSR52	Polypropylene Reducer Fitting, 5/32" to 1/16" Hose Barb
	HSR5230	White Nylon Reducer Fitting, 5/32" to 1/16" Hose Barb
	HSR5231	Black Nylon Reducer Fitting, 5/32" to 1/16" Hose Barb
	HSR5270	PVDF Straight Reducer Fitting, 5/32" to 1/16" Hose Barb
	HSR5291	Purple Tint Polycarbonate Reducer Fitting, 5/32" to 1/16" Hose Barb
	HSR53	Polypropylene Reducer Fitting, 5/32" to 3/32" Hose Barb
	HSR5330	White Nylon Reducer Fitting, 5/32" to 3/32" Hose Barb
	HSR5331	Black Nylon Reducer Fitting, 5/32" to 3/32" Hose Barb
	HSR5370	PVDF Straight Reducer Fitting, 5/32" to 3/32" Hose Barb
	HSR5391	Purple Tint Polycarbonate Reducer Fitting, 5/32" to 3/32" Hose Barb
	HSR54	Polypropylene Reducer Fitting, 5/32" to 1/8" Hose Barb
	HSR5430	White Nylon Reducer Fitting, 5/32" to 1/8" Hose Barb
	HSR5431	Black Nylon Reducer Fitting, 5/32" to 1/8" Hose Barb
	HSR5470	PVDF Straight Reducer Fitting, 5/32" to 1/8" Hose Barb
	HSR5491	Purple Tint Polycarbonate Reducer Fitting, 5/32" to 1/8" Hose Barb
	HSR62	Polypropylene Reducer Fitting, 3/16" to 1/16" Hose Barb
	HSR6230	White Nylon Reducer Fitting, 3/16" to 1/16" Hose Barb
	HSR6231	Black Nylon Reducer Fitting, 3/16" to 1/16" Hose Barb
	HSR6270	PVDF Straight Reducer Fitting, 3/16" to 1/16" Hose Barb
	HSR6291	Purple Tint Polycarbonate Reducer Fitting, 3/16" to 1/16" Hose Barb
	HSR63	Polypropylene Reducer Fitting, 3/16" to 3/32" Hose Barb
	HSR6330	White Nylon Reducer Fitting, 3/16" to 3/32" Hose Barb
	HSR6331	Black Nylon Reducer Fitting, 3/16" to 3/32" Hose Barb
	HSR6370	PVDF Straight Reducer Fitting, 3/16" to 3/32" Hose Barb
	HSR6391	Purple Tint Polycarbonate Reducer Fitting, 3/16" to 3/32" Hose Barb
	HSR64	Polypropylene Reducer Fitting, 3/16" to 1/8" Hose Barb
	HSR6430	White Nylon Reducer Fitting, 3/16" to 1/8" Hose Barb
	HSR6431	Black Nylon Reducer Fitting, 3/16" to 1/8" Hose Barb
	HSR6470	PVDF Straight Reducer Fitting, 3/16" to 1/8" Hose Barb
	HSR6491	Purple Tint Polycarbonate Reducer Fittings, 3/16" to 1/8" Hose Barb
	HSR65	Polypropylene Reducer Fitting, 3/16" to 5/32" Hose Barb
	HSR6530	White Nylon Reducer Fitting, 3/16" to 5/32" Hose Barb
	HSR6531	Black Nylon Reducer Fitting, 3/16" to 5/32" Hose Barb
	HSR6570	PVDF Straight Reducer Fitting, 3/16" to 5/32" Hose Barb
	HSR6591	Purple Tint Polycarbonate Reducer Fittings, 3/16" to 5/32" Hose Barb





TUBE TO TUBE FITTINGS

TUBE TO TUBE FITTINGS - STRAIGHT REDUCER

PART NO.	DESCRIPTION
 HSR84	Polypropylene Reducer Fitting, 1/4" to 1/8" Hose Barb
HSR8430	White Nylon Reducer Fitting, 1/4" to 1/8" Hose Barb
HSR8431	Black Nylon Reducer Fitting, 1/4" to 1/8" Hose Barb
HSR8470	PVDF Straight Reducer Fitting, 1/4" to 1/8" Hose Barb
HSR8491	Purple Tint Polycarbonate Reducer Fittings, 1/4" to 1/8" Hose Barb
<hr/>	
 HSR85	Polypropylene Reducer Fitting, 1/4" to 5/32" Hose Barb
HSR8530	White Nylon Reducer Fitting, 1/4" to 5/32" Hose Barb
HSR8531	Black Nylon Reducer Fitting, 1/4" to 5/32" Hose Barb
HSR8570	PVDF Straight Reducer Fitting, 1/4" to 5/32" Hose Barb
HSR8591	Purple Tint Polycarbonate Reducer Fittings, 1/4" to 5/32" Hose Barb
<hr/>	
 HSR86	Polypropylene Reducer Fitting, 1/4" to 3/16" Hose Barb
HSR8630	White Nylon Reducer Fitting, 1/4" to 3/16" Hose Barb
HSR8631	Black Nylon Reducer Fitting, 1/4" to 3/16" Hose Barb
HSR8670	PVDF Straight Reducer Fitting, 1/4" to 3/16" Hose Barb
HSR8691	Purple Tint Polycarbonate Reducer Fittings, 1/4" to 3/16" Hose Barb
<hr/>	
 HSR128	Polypropylene Reducer Fitting, 3/8" to 1/4" Hose Barb
HSR12830	White Nylon Reducer Fitting, 3/8" to 1/4" Hose Barb
HSR12831	Black Nylon Reducer Fitting, 3/8" to 1/4" Hose Barb
HSR12870	PVDF Straight Reducer Fitting, 3/8" to 1/4" Hose Barb

PLUGS AND THREAD TO THREAD

THREADED PLUGS













PART NO.	DESCRIPTION
 MP	Polypropylene Threaded Plug, Tapered 10-32
MP30	White Nylon Threaded Plug, Tapered 10-32
MP31	Black Nylon Threaded Plug, Tapered 10-32
MP70	PVDF Threaded Plug Fitting, Tapered 10-32
<hr/>	
 N2P	Polypropylene Threaded Plug, 1/16" NPT
N2P30	White Nylon Threaded Plug, 1/16" NPT
N2P31	Black Nylon Threaded Plug, 1/16" NPT
N2P70	PVDF Threaded Plug, 1/16" NPT
<hr/>	
 N4P	Polypropylene Threaded Plug, 1/8" NPT
N4P30	White Nylon Threaded Plug, 1/8" NPT
N4P31	Black Nylon Threaded Plug, 1/8" NPT
N4P70	PVDF Threaded Plug Fitting, 1/8" NPT
<hr/>	
 N8P	Polypropylene Threaded Plug, 1/4" NPT
N8P30	White Nylon Threaded Plug, 1/4" NPT
N8P31	Black Nylon Threaded Plug, 1/4" NPT
N8P70	PVDF Threaded Plug Fitting, 1/4" NPT

THREAD TO THREAD - STRAIGHT

PART NO.	DESCRIPTION
 N32	Polypropylene Straight Fitting, Tapered 10-32 Threads
N3230	White Nylon Straight Fitting, Tapered 10-32 Threads
N3231	Black Nylon Straight Fitting, Tapered 10-32 Threads
N3270	PVDF Straight Fitting, Tapered 10-32 Threads

THREAD TO TUBE FITTINGS

THREAD TO TUBE FITTINGS - STRAIGHT



PART NO.	DESCRIPTION
 KS2	Polypropylene Straight Fitting, 1/4-28 UNF to 1/16" Hose Barb
KS230	White Nylon Straight Fitting, 1/4-28 UNF to 1/16" Hose Barb
KS231	Black Nylon Straight Fitting, 1/4-28 UNF to 1/16" Hose Barb
KS270	PVDF Straight Fitting, 1/4-28 UNF to 1/16" Hose Barb
<hr/>	
 KS3	Polypropylene Straight Fitting, 1/4-28 UNF to 3/32" Hose Barb
KS330	White Nylon Straight Fitting, 1/4-28 UNF to 3/32" Hose Barb
KS331	Black Nylon Straight Fitting, 1/4-28 UNF to 3/32" Hose Barb
KS370	PVDF Straight Fitting, 1/4-28 UNF to 3/32" Hose Barb
<hr/>	
 KS4	Polypropylene Straight Fitting, 1/4-28 UNF to 1/8" Hose Barb
KS430	White Nylon Straight Fitting, 1/4-28 UNF to 1/8" Hose Barb
KS431	Black Nylon Straight Fitting, 1/4-28 UNF to 1/8" Hose Barb
KS470	PVDF Straight Fitting, 1/4-28 UNF to 1/8" Hose Barb
<hr/>	
 KS5	Polypropylene Straight Fitting, 1/4-28 UNF to 5/32" Hose Barb
KS530	White Nylon Straight Fitting, 1/4-28 UNF to 5/32" Hose Barb
KS531	Black Nylon Straight Fitting, 1/4-28 UNF to 5/32" Hose Barb
KS570	PVDF Straight Fitting, 1/4-28 UNF to 5/32" Hose Barb
<hr/>	
 MS2	Polypropylene Straight Fitting, Tapered 10-32 to 1/16" Hose Barb
MS230	White Nylon Straight Fitting, Tapered 10-32 to 1/16" Hose Barb
MS231	Black Nylon Straight Fitting, Tapered 10-32 to 1/16" Hose Barb
MS270	PVDF Straight Fitting, Tapered 10-32 to 1/16" Hose Barb
<hr/>	
 MS3	Polypropylene Straight Fitting, Tapered 10-32 to 3/32" Hose Barb
MS330	White Nylon Straight Fitting, Tapered 10-32 to 3/32" Hose Barb
MS331	Black Nylon Straight Fitting, Tapered 10-32 to 3/32" Hose Barb
MS370	PVDF Straight Fitting, Tapered 10-32 to 3/32" Hose Barb
<hr/>	
 MS4	Polypropylene Straight Fitting, Tapered 10-32 to 1/8" Hose Barb
MS430	White Nylon Straight Fitting, Tapered 10-32 to 1/8" Hose Barb
MS431	Black Nylon Straight Fitting, Tapered 10-32 to 1/8" Hose Barb
MS470	PVDF Straight Fitting, Tapered 10-32 to 1/8" Hose Barb
<hr/>	
 MS5	Polypropylene Straight Fitting, Tapered 10-32 to 5/32" Hose Barb
MS530	White Nylon Straight Fitting, Tapered 10-32 to 5/32" Hose Barb
MS531	Black Nylon Straight Fitting, Tapered 10-32 to 5/32" Hose Barb
MS570	PVDF Straight Fitting, Tapered 10-32 to 5/32" Hose Barb
<hr/>	
 N2S2	Polypropylene Straight Fitting, 1/16" NPT to 1/16" Hose Barb
N2S230	White Nylon Straight Fitting, 1/16" NPT to 1/16" Hose Barb
N2S231	Black Nylon Straight Fitting, 1/16" NPT to 1/16" Hose Barb
N2S270	PVDF Straight Fitting, 1/16" NPT to 1/16" Hose Barb
<hr/>	
 N2S3	Polypropylene Straight Fitting, 1/16" NPT to 3/32" Hose Barb
N2S330	White Nylon Straight Fitting, 1/16" NPT to 3/32" Hose Barb
N2S331	Black Nylon Straight Fitting, 1/16" NPT to 3/32" Hose Barb
N2S370	PVDF Straight Fitting, 1/16" NPT to 3/32" Hose Barb
<hr/>	
 N2S4	Polypropylene Straight Fitting, 1/16" NPT to 1/8" Hose Barb
N2S430	White Nylon Straight Fitting, 1/16" NPT to 1/8" Hose Barb
N2S431	Black Nylon Straight Fitting, 1/16" NPT to 1/8" Hose Barb
N2S470	PVDF Straight Fitting, 1/16" NPT to 1/8" Hose Barb
<hr/>	
 N2S5	Polypropylene Straight Fitting, 1/16" NPT to 5/32" Hose Barb
N2S530	White Nylon Straight Fitting, 1/16" NPT to 5/32" Hose Barb
N2S531	Black Nylon Straight Fitting, 1/16" NPT to 5/32" Hose Barb
N2S570	PVDF Straight Fitting, 1/16" NPT to 5/32" Hose Barb
<hr/>	
 N4S2	Polypropylene Straight Fitting, 1/8" NPT to 1/16" Hose Barb
N4S230	White Nylon Straight Fitting, 1/8" NPT to 1/16" Hose Barb
N4S231	Black Nylon Straight Fitting, 1/8" NPT to 1/16" Hose Barb
N4S270	PVDF Straight Fitting, 1/8" NPT to 1/16" Hose Barb

Note: Parts not shown to scale. For customer drawings and technical specifications please visit cpcworldwide.com

THREAD TO TUBE FITTINGS - STRAIGHT (CONT.)

	PART NO.	DESCRIPTION
	N4S3 N4S330 N4S331 N4S370	Polypropylene Straight Fitting, 1/8" NPT to 3/32" Hose Barb White Nylon Straight Fitting, 1/8" NPT to 3/32" Hose Barb Black Nylon Straight Fitting, 1/8" NPT to 3/32" Hose Barb PVDF Straight Fitting, 1/8" NPT to 3/32" Hose Barb
	N4S4 N4S430 N4S431 N4S470	Polypropylene Straight Fitting, 1/8" NPT to 1/8" Hose Barb White Nylon Straight Fitting, 1/8" NPT to 1/8" Hose Barb Black Nylon Straight Fitting, 1/8" NPT to 1/8" Hose Barb PVDF Straight Fitting, 1/8" NPT to 1/8" Hose Barb
	N4S5 N4S530 N4S531 N4S570	Polypropylene Straight Fitting, 1/8" NPT to 5/32" Hose Barb White Nylon Straight Fitting, 1/8" NPT to 5/32" Hose Barb Black Nylon Straight Fitting, 1/8" NPT to 5/32" Hose Barb PVDF Straight Fitting, 1/8" NPT to 5/32" Hose Barb
	N4S6 N4S630 N4S631 N4S670	Polypropylene Straight Fitting, 1/8" NPT to 3/16" Hose Barb White Nylon Straight Fitting, 1/8" NPT to 3/16" Hose Barb Black Nylon Straight Fitting, 1/8" NPT to 3/16" Hose Barb PVDF Straight Fitting, 1/8" NPT to 3/16" Hose Barb
	N4S8 N4S830 N4S831 N4S870	Polypropylene Straight Fitting, 1/8" NPT to 1/4" Hose Barb White Nylon Straight Fitting, 1/8" NPT to 1/4" Hose Barb Black Nylon Straight Fitting, 1/8" NPT to 1/4" Hose Barb PVDF Straight Fitting, 1/8" NPT to 1/4" Hose Barb
	N8S4 N8S430 N8S431 N8S470	Polypropylene Straight Fitting, 1/4" NPT to 1/8" Hose Barb White Nylon Straight Fitting, 1/4" NPT to 1/8" Hose Barb Black Nylon Straight Fitting, 1/4" NPT to 1/8" Hose Barb PVDF Straight Fitting, 1/4" NPT to 1/8" Hose Barb
	N8S5 N8S530 N8S531 N8S570	Polypropylene Straight Fitting, 1/4" NPT to 5/32" Hose Barb White Nylon Straight Fitting, 1/4" NPT to 5/32" Hose Barb Black Nylon Straight Fitting, 1/4" NPT to 5/32" Hose Barb PVDF Straight Fitting, 1/4" NPT to 5/32" Hose Barb
	N8S6 N8S630 N8S631 N8S670	Polypropylene Straight Fitting, 1/4" NPT to 3/16" Hose Barb White Nylon Straight Fitting, 1/4" NPT to 3/16" Hose Barb Black Nylon Straight Fitting, 1/4" NPT to 3/16" Hose Barb PVDF Straight Fitting, 1/4" NPT to 3/16" Hose Barb
	N8S8 N8S830 N8S831 N8S870	Polypropylene Straight Fitting, 1/4" NPT to 1/4" Hose Barb White Nylon Straight Fitting, 1/4" NPT to 1/4" Hose Barb Black Nylon Straight Fitting, 1/4" NPT to 1/4" Hose Barb PVDF Straight Fitting, 1/4" NPT to 1/4" Hose Barb
	N8S10 N8S1030 N8S1031 N8S1070	Polypropylene Straight Fitting, 1/4" NPT to 5/16" Hose Barb White Nylon Straight Fitting, 1/4" NPT to 5/16" Hose Barb Black Nylon Straight Fitting, 1/4" NPT to 5/16" Hose Barb PVDF Straight Fitting, 1/4" NPT to 5/16" Hose Barb
	N8S12 N8S1230 N8S1231 N8S1270	Polypropylene Straight Fitting, 1/4" NPT to 3/8" Hose Barb White Nylon Straight Fitting, 1/4" NPT to 3/8" Hose Barb Black Nylon Straight Fitting, 1/4" NPT to 3/8" Hose Barb PVDF Straight Fitting, 1/4" NPT to 3/8" Hose Barb





THREAD TO TUBE FITTINGS - ELBOW

	PART NO.	DESCRIPTION
	ME2 ME230 ME231 ME270	Polypropylene Elbow Fitting, Tapered 10-32 to 1/16" Hose Barb White Nylon Elbow Fitting, Tapered 10-32 to 1/16" Hose Barb Black Nylon Elbow Fitting, Tapered 10-32 to 1/16" Hose Barb PVDF Elbow Fitting, Tapered 10-32 to 1/16" Hose Barbs
	ME3 ME330 ME331 ME370	Polypropylene Elbow Fitting, Tapered 10-32 to 3/32" Hose Barb White Nylon Elbow Fitting, Tapered 10-32 to 3/32" Hose Barb Black Nylon Elbow Fitting, Tapered 10-32 to 3/32" Hose Barb PVDF Elbow Fitting, Tapered 10-32 to 3/32" Hose Barbs

THREAD TO TUBE FITTINGS - ELBOW (CONT)

	PART NO.	DESCRIPTION
	ME4 ME430 ME431 ME470	Polypropylene Elbow Fitting, Tapered 10-32 to 1/8" Hose Barb White Nylon Elbow Fitting, Tapered 10-32 to 1/8" Hose Barb Black Nylon Elbow Fitting, Tapered 10-32 to 1/8" Hose Barb PVDF Elbow Fitting, Tapered 10-32 to 1/8" Hose Barbs
	ME5 ME530 ME531 ME570	Polypropylene Elbow Fitting, Tapered 10-32 to 5/32" Hose Barb White Nylon Elbow Fitting, Tapered 10-32 to 5/32" Hose Barb Black Nylon Elbow Fitting, Tapered 10-32 to 5/32" Hose Barb PVDF Elbow Fitting, Tapered 10-32 to 5/32" Hose Barbs
	N4E4 N4E430 N4E431 N4E470	Polypropylene Elbow Fitting, 1/8" NPT to 1/8" Hose Barb White Nylon Elbow Fitting, 1/8" NPT to 1/8" Hose Barb Black Nylon Elbow Fitting, 1/8" NPT to 1/8" Hose Barb PVDF Elbow Fitting, 1/8" NPT to 1/8" Hose Barb
	N4E6 N4E630 N4E631 N4E670	Polypropylene Elbow Fitting, 1/8" NPT to 3/16" Hose Barb White Nylon Elbow Fitting, 1/8" NPT to 3/16" Hose Barb Black Nylon Elbow Fitting, 1/8" NPT to 3/16" Hose Barb PVDF Elbow Fitting, 1/8" NPT to 3/16" Hose Barb
	N4E8 N4E830 N4E831 N4E870	Polypropylene Elbow Fitting, 1/8" NPT to 1/4" Hose Barb White Nylon Elbow Fitting, 1/8" NPT to 1/4" Hose Barb Black Nylon Elbow Fitting, 1/8" NPT to 1/4" Hose Barb PVDF Elbow Fitting, 1/8" NPT to 1/4" Hose Barb
	N8E8 N8E830 N8E831 N8E870	Polypropylene Elbow Fitting, 1/4" NPT to 1/4" Hose Barb White Nylon Elbow Fitting, 1/4" NPT to 1/4" Hose Barb Black Nylon Elbow Fitting, 1/4" NPT to 1/4" Hose Barb PVDF Elbow Fitting, 1/4" NPT to 1/4" Hose Barb
	N8E12 N8E1230 N8E1231 N8E1270	Polypropylene Elbow Fitting, 1/4" NPT to 3/8" Hose Barb White Nylon Elbow Fitting, 1/4" NPT to 3/8" Hose Barb Black Nylon Elbow Fitting, 1/4" NPT to 3/8" Hose Barb PVDF Elbow Fitting, 1/4" NPT to 3/8" Hose Barb

THREAD TO TUBE FITTINGS - TEE









	PART NO.	DESCRIPTION
	MT2 MT230 MT231 MT270	Polypropylene Tee Fitting, Tapered 10-32 to 1/16" Hose Barbs White Nylon Tee Fitting, Tapered 10-32 to 1/16" Hose Barbs Black Nylon Tee Fitting, Tapered 10-32 to 1/16" Hose Barbs PVDF Tee Fitting, Tapered 10-32 to 1/16" Hose Barbs
	MT3 MT330 MT331 MT370	Polypropylene Tee Fitting, Tapered 10-32 to 3/32" Hose Barbs White Nylon Tee Fitting, Tapered 10-32 to 3/32" Hose Barbs Black Nylon Tee Fitting, Tapered 10-32 to 3/32" Hose Barbs PVDF Tee Fitting, Tapered 10-32 to 3/32" Hose Barbs
	MT4 MT430 MT431 MT470	Polypropylene Tee Fitting, Tapered 10-32 to 1/8" Hose Barbs White Nylon Tee Fitting, Tapered 10-32 to 1/8" Hose Barbs Black Nylon Tee Fitting, Tapered 10-32 to 1/8" Hose Barbs PVDF Tee Fitting, Tapered 10-32 to 1/8" Hose Barbs
	MT5 MT530 MT531 MT570	Polypropylene Tee Fitting, Tapered 10-32 to 5/32" Hose Barbs White Nylon Tee Fitting, Tapered 10-32 to 5/32" Hose Barbs Black Nylon Tee Fitting, Tapered 10-32 to 5/32" Hose Barbs PVDF Tee Fitting, Tapered 10-32 to 5/32" Hose Barbs

NOTE







The unique shrouded hose barb on our 1/16" fittings provides additional stability to prevent breakage in applications where small tubing connections might be pulled or twisted during use.

BLOOD PRESSURE

BLOOD PRESSURE FITTINGS - MALE BAYONET

	PART NO.	DESCRIPTION
	BC330	White Nylon Male Bayonet Fitting to 3/32" Hose Barb
	BC331	Black Nylon Male Bayonet Fitting to 3/32" Hose Barb
	BC430	White Nylon Male Bayonet Fitting to 1/8" Hose Barb
	BC431	Black Nylon Male Bayonet Fitting to 1/8" Hose Barb
	BC530	White Nylon Male Bayonet Fitting to 5/32" Hose Barb
	BC531	Black Nylon Male Bayonet Fitting to 5/32" Hose Barb
	BC630	White Nylon Male Bayonet Fitting to 3/16" Hose Barb
	BC631	Black Nylon Male Bayonet Fitting to 3/16" Hose Barb

BLOOD PRESSURE FITTINGS - SCREW-TYPE

























	PART NO.	DESCRIPTION
	GS320	White Acetal Screw-type Fitting, 5/16" UNF to 3/32" Hose Barb
	GS420	White Acetal Screw-type Fitting, 5/16" UNF to 1/8" Hose Barb
	GS520	White Acetal Screw-type Fitting, 5/16" UNF to 5/32" Hose Barb
	GS620	White Nylon with Polypropylene and TPE rotating nut, Buna-N seal. 5/16" UNF rotating internal thread X 1/8" HB
	GM430M2	White Nylon with Polypropylene and TPE rotating nut, Buna-N seal. 5/16" UNF rotating internal thread X 5/32" HB
	GM530M2	White Nylon with Polypropylene and TPE rotating nut, Buna-N seal. 5/16" UNF rotating internal thread X 5/32" HB
	GM630M2	White Nylon with Polypropylene and TPE rotating nut, Buna-N seal. 5/16" UNF rotating internal thread X 3/16" HB

NOTE

Male luers feature an integral locking ring!

LUERS

MALE LUERS

	PART NO.	DESCRIPTION
	LM21	Polypropylene Male Luer to 1/16" Hose Barb
	LM2130	White Nylon Male Luer to 1/16" Hose Barb
	LM2131	Black Nylon Male Luer to 1/16" Hose Barb
	LM2170	PVDF Male Luer to 1/16" Hose Barb
	LM2191	Purple Tint Polycarbonate Male Luer to 1/16" Hose Barb
	LM31	Polypropylene Male Luer to 3/32" Hose Barb
	LM3130	White Nylon Male Luer to 3/32" Hose Barb
	LM3131	Black Nylon Male Luer to 3/32" Hose Barb
	LM3170	PVDF Male Luer to 3/32" Hose Barb
	LM3191	Purple Tint Polycarbonate Male Luer to 3/32" Hose Barb
	LM41	Polypropylene Male Luer to 1/8" Hose Barb
	LM4130	White Nylon Male Luer to 1/8" Hose Barb
	LM4131	Black Nylon Male Luer to 1/8" Hose Barb
	LM4170	PVDF Male Luer to 1/8" Hose Barb
	LM4191	Purple Tint Polycarbonate Male Luer to 1/8" Hose Barb
	LM51	Polypropylene Male Luer to 5/32" Hose Barb
	LM5130	White Nylon Male Luer to 5/32" Hose Barb
	LM5131	Black Nylon Male Luer to 5/32" Hose Barb
	LM5170	PVDF Male Luer to 5/32" Hose Barb
	LM5191	Purple Tint Polycarbonate Male Luer to 5/32" Hose Barb
	LM61	Polypropylene Male Luer to 3/16" Hose Barb
	LM6130	White Nylon Male Luer to 3/16" Hose Barb
	LM6131	Black Nylon Male Luer to 3/16" Hose Barb
	LM6191	Purple Tint Polycarbonate Male Luer to 3/16" Hose Barb
	LM8170	PVDF Male Luer to 1/4" Hose Barb



NOTE

For SMC and SMF1 blood pressure connectors, see page 24-27.

FEMALE LUERS

	PART NO.	DESCRIPTION
	LF21	Polypropylene Female Luer to 1/16" Hose Barb
	LF2130	White Nylon Female Luer to 1/16" Hose Barb
	LF2131	Black Nylon Female Luer to 1/16" Hose Barb
	LF2170	PVDF Female Luer to 1/16" Hose Barb
	LF2191	Purple Tint Polycarbonate Female Luer to 1/16" Hose Barb
	LF31	Polypropylene Female Luer to 3/32" Hose Barb
	LF3130	White Nylon Female Luer to 3/32" Hose Barb
	LF3131	Black Nylon Female Luer to 3/32" Hose Barb
	LF3170	PVDF Female Luer to 3/32" Hose Barb
	LF3191	Purple Tint Polycarbonate Female Luer to 3/32" Hose Barb
	LF41	Polypropylene Female Luer to 1/8" Hose Barb
	LF4130	White Nylon Female Luer to 1/8" Hose Barb
	LF4131	Black Nylon Female Luer to 1/8" Hose Barb
	LF4170	PVDF Female Luer to 1/8" Hose Barb
	LF4191	Purple Tint Polycarbonate Female Luer to 1/8" Hose Barb
	LF51	Polypropylene Female Luer to 5/32" Hose Barb
	LF5130	White Nylon Female Luer to 5/32" Hose Barb
	LF5131	Black Nylon Female Luer to 5/32" Hose Barb
	LF5170	PVDF Female Luer to 5/32" Hose Barb
	LF5191	Purple Tint Polycarbonate Female Luer to 5/32" Hose Barb
	LF61	Polypropylene Female Luer to 3/16" Hose Barb
	LF6130	White Nylon Female Luer to 3/16" Hose Barb
	LF6131	Black Nylon Female Luer to 3/16" Hose Barb
	LF6170	PVDF Female Luer to 3/16" Hose Barb
	LF6191	Purple Tint Polycarbonate Female Luer to 3/16" Hose Barb
	LF81	Polypropylene Female Luer to 1/4" Hose Barb
	LF8130	White Nylon Female Luer to 1/4" Hose Barb
	LF8131	Black Nylon Female Luer to 1/4" Hose Barb
	LF8170	PVDF Female Luer to 1/4" Hose Barb
	LF8191	Purple Tint Polycarbonate Female Luer to 1/4" Hose Barb

PANEL MOUNT MALE LUERS

PART NO.	DESCRIPTION
PMLM21	Polypropylene Panel Mount Male Luer to 1/16" Hose Barb
PMLM2130	White Nylon Panel Mount Male Luer to 1/16" Hose Barb
PMLM2131	Black Nylon Panel Mount Male Luer to 1/16" Hose Barb
PMLM31	Polypropylene Panel Mount Male Luer to 3/32" Hose Barb
PMLM3130	White Nylon Panel Mount Male Luer to 3/32" Hose Barb
PMLM3131	Black Nylon Panel Mount Male Luer to 3/32" Hose Barb
PMLM3170	PVDF Panel Mount Male Luer to 3/32" Hose Barb
PMLM41	Polypropylene Panel Mount Male Luer to 1/8" Hose Barb
PMLM4130	White Nylon Panel Mount Male Luer to 1/8" Hose Barb
PMLM4131	Black Nylon Panel Mount Male Luer to 1/8" Hose Barb
PMLM4170	PVDF Panel Mount Male Luer to 1/8" Hose Barb
PMNUTSST	Stainless Steel 1/4-28 UNF Nut
PMNUT30	White Nylon Panel Mount 1/4-28 UNF Nut

Note: Panel mount luers require a 1/4" diameter panel opening

NOTE

All CPC luer fittings and connectors interconnect with products manufactured to ISO standards 594-1 and 594-2.

NOTE

Color-coded rings can be used for visual line identification or to prevent connector rotation in panel mount applications.

PANEL MOUNT FEMALE LUERS

PART NO.	DESCRIPTION
PMLF21	Polypropylene Panel Mount Female Luer to 1/16" Hose Barb
PMLF2130	White Nylon Panel Mount Female Luer to 1/16" Hose Barb
PMLF2131	Black Nylon Panel Mount Female Luer to 1/16" Hose Barb
PMLF2170	PVDF Panel Mount Female Luer to 1/16" Hose Barb
PMLF31	Polypropylene Panel Mount Female Luer to 3/32" Hose Barb
PMLF3130	White Nylon Panel Mount Female Luer to 3/32" Hose Barb
PMLF3131	Black Nylon Panel Mount Female Luer to 3/32" Hose Barb
PMLF3170	PVDF Panel Mount Female Luer to 3/32" Hose Barb
PMLF41	Polypropylene Panel Mount Female Luer to 1/8" Hose Barb
PMLF4130	White Nylon Panel Mount Female Luer to 1/8" Hose Barb
PMLF4131	Black Nylon Panel Mount Female Luer to 1/8" Hose Barb
PMLF4170	PVDF Panel Mount Female Luer to 1/8" Hose Barb
PMNUTSST	Stainless Steel 1/4-28 UNF Nut
PMNUT30	White Nylon Panel Mount 1/4-28 UNF Nut

LUER CAPS AND PLUGS

PART NO.	DESCRIPTION
LCAP	Polypropylene Luer Cap
LCAP30	White Nylon Luer Cap
LCAP31	Black Nylon Luer Cap
LCAP70	PVDF Luer Cap
LPLUG	Polypropylene Luer Plug
LPLUG30	White Nylon Luer Plug
LPLUG31	Black Nylon Luer Plug
LPLUG70	PVDF Luer Plug

MALE SLIP LUERS

PART NO.	DESCRIPTION
SLM21	Polypropylene Male Slip Luer to 1/16" Hose Barb
SLM2130	White Nylon Male Slip Luer to 1/16" Hose Barb
SLM2131	Black Nylon Male Slip Luer to 1/16" Hose Barb
SLM2170	PVDF Male Slip Luer to 1/16" Hose Barb
SLM2191	Purple Tint Polycarbonate Male Slip Luer to 1/16" Hose Barb
SLM31	Polypropylene Male Slip Luer to 3/32" Hose Barb
SLM3130	White Nylon Male Slip Luer to 3/32" Hose Barb
SLM3131	Black Nylon Male Slip Luer to 3/32" Hose Barb
SLM3170	PVDF Male Slip Luer to 3/32" Hose Barb
SLM3191	Purple Tint Polycarbonate Male Slip Luer to 3/32" Hose Barb
SLM41	Polypropylene Male Slip Luer to 1/8" Hose Barb
SLM4130	White Nylon Male Slip Luer to 1/8" Hose Barb
SLM4131	Black Nylon Male Slip Luer to 1/8" Hose Barb
SLM4170	PVDF Male Slip Luer to 1/8" Hose Barb
SLM4191	Purple Tint Polycarbonate Male Slip Luer to 1/8" Hose Barb
SLM51	Polypropylene Male Slip Luer to 5/32" Hose Barb
SLM5130	White Nylon Male Slip Luer to 5/32" Hose Barb
SLM5131	Black Nylon Male Slip Luer to 5/32" Hose Barb
SLM5170	PVDF Male Slip Luer to 5/32" Hose Barb
SLM5191	Purple Tint Polycarbonate Male Slip Luer to 5/32" Hose Barb
SLM61	Polypropylene Male Slip Luer to 3/16" Hose Barb
SLM6130	White Nylon Male Slip Luer to 3/16" Hose Barb
SLM6131	Black Nylon Male Slip Luer to 3/16" Hose Barb
SLM6170	PVDF Male Slip Luer to 3/16" Hose Barb
SLM6191	Purple Tint Polycarbonate Male Slip Luer to 3/16" Hose Barb

LUER ACCESSORIES

PART NO.	DESCRIPTION
LMSL	Polypropylene Stationary Luer Lock Ring
LMSL30	White Nylon Stationary Luer Lock Ring
LMSL31	Black Nylon Stationary Luer Lock Ring
LMSL32	Yellow Nylon Stationary Luer Lock Ring
LMSL33	Blue Nylon Stationary Luer Lock Ring
LMSL34	Red Nylon Stationary Luer Lock Ring
LMSL35	Green Nylon Stationary Luer Lock Ring
LMSL36	Orange Nylon Stationary Luer Lock Ring
LMSL70	PVDF Stationary Luer Lock Ring
LMSL91	Purple Tint Polycarbonate Stationary Luer Lock Ring
LMSR	Polypropylene Rotating Luer Lock Ring
LMSR30	White Nylon Rotating Luer Lock Ring
LMSR31	Black Nylon Rotating Luer Lock Ring
LMSR32	Yellow Nylon Rotating Luer Lock Ring
LMSR33	Blue Nylon Rotating Luer Lock Ring
LMSR34	Red Nylon Rotating Luer Lock Ring
LMSR35	Green Nylon Rotating Luer Lock Ring
LMSR36	Orange Nylon Rotating Luer Lock Ring
LMSR70	PVDF Rotating Luer Lock Ring
LMSLR91	Purple Tint Polycarbonate Rotating Luer Lock Ring
PMRL	Polypropylene Luer Color Coded Ring
PMRL30	White Nylon Luer Color Coded Ring
PMRL31	Black Nylon Luer Color Coded Ring
PMRL32	Yellow Nylon Luer Color Coded Ring
PMRL33	Blue Nylon Luer Color Coded Ring
PMRL34	Red Nylon Luer Color Coded Ring
PMRL35	Green Nylon Luer Color Coded Ring
PMRL36	Orange Nylon Luer Color Coded Ring
PMRL70	PVDF Panel Mount Luer Color Coded Ring

PMNUTSST	Stainless Steel 1/4-28 UNF Nut
----------	--------------------------------



CPC offers many accessories for quick disconnect couplings and fittings to help design fluid handling solutions that are useful, versatile and optimized for performance. Accessory options include:

- Nuts and Ferrules
- O-Rings and Seals
- Caps and Plugs
- Panel Mount Nuts
- Manifolds
- Locking Clips

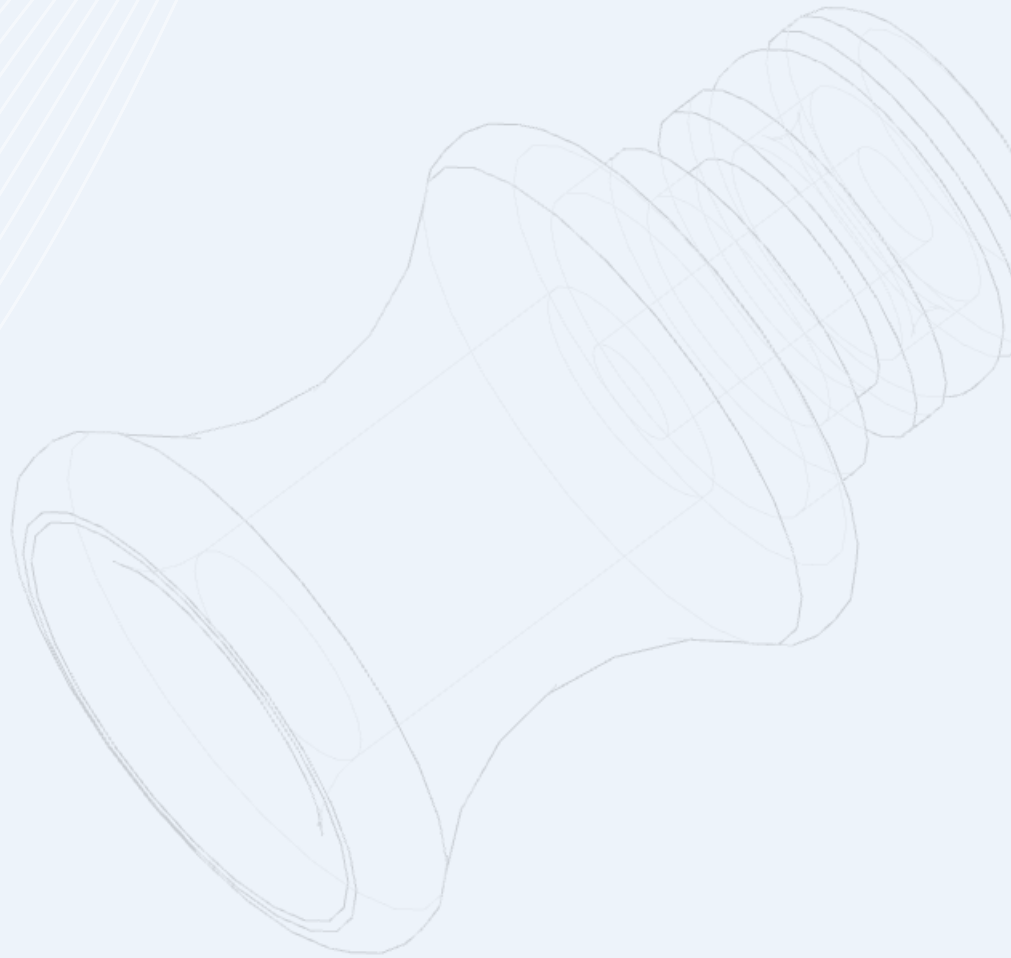

ACCESSORIES

ACCESSORIES



TERMINATION	PIPE THREAD	TUBING	TUBING DIMENSION	PART NO.	LENGTH
FERRULELESS POLYTUBE FITTING, PTF†	10-32*	1/8"	0.07" ID 0.125 OD	TF1002	0.64
	10-32*	1/4"	0.17" ID 0.250 OD	TF1004	0.86
	1/8" NPT	1/8"	0.07" ID 0.125 OD	TF2002	0.98
	1/8" NPT	1/4"	0.17" ID 0.250 OD	TF2004	1.10
	1/8" NPT	3/8"	0.25" ID 0.375 OD	TF2006	1.24
	1/4" NPT	1/4"	0.17" ID 0.250 OD	TF4004	1.20
	1/4" NPT	3/8"	0.25" ID 0.375 OD	TF4006	1.34



TERMINATION	TUBING	PART NO.	TUBING	PART NO.
FERRULELESS POLYTUBE FITTING NUTS, PTF†	1/8" OD	153600	4.0mm OD	269700
	5/32" OD	269700	8.0mm OD	339500
	1/4" OD	100800	10.0mm OD	358400
	3/8" OD	108900		



TERMINATION	COUPLING SERIES	BUNA-N	FLUOROCARBON	EPDM
INSERT SEALS	MC, PMC, PMC12	730800	730804	730803
	LC, PLC, PLC12, APC, Twin Tube™ (large o-ring), ZLC, NS4, NS406, BreakAway®	731100	731104	731103
	SMC, Twin Tube (small o-ring)	730600	730604	730603
	HFC (all), FFC	731600	731604	731603
	NS1 Bulkhead Seal			731303
	NS6		731404	731403



TERMINATION	COUPLING SERIES NUTS	NICKEL BRASS	ACETAL	316 STAINLESS	POLYPROPYLENE (PP) POLYSULFONE (PSF)
PANEL MOUNT NUTS	MC, PMC, PMC12	100900	664400	100901	
	LC, PLC, EFC, PLC12, APC, ZLC, BreakAway	120700	520300	120701	621300 (PP)
	HFC, PLC-NSF, LC-NSF, APC-NSF				694300 (PSF)
	SRC, SMF	404300			
	NS4 ABS	2137600			
	NS6				1884400



TERMINATION	COUPLING SERIES	BODY PLUG	INSERT CAP
DUST CAPS & PLUGS	MC, PMC non-sealing	PMC31	PMC32
	LC, PLC non-sealing	PLC310	PLC320
	APC, EFC non-sealing		PLC320
	PMC pressure-sealing	PMC30	
	PLC pressure-sealing	PLC300	
	HFC/FFC non-sealing (not shown)	HFC312 L (with leash)	



TERMINATION	PIPE THREAD	TUBING	HEX NUT SIZE	MAX PANEL THICKNESS	PART NO.	LENGTH	HOSEBARB LENGTH
PANEL MOUNT UNION DOUBLE HOSE BARB	1/2"-24 Thread	1/8"	5/8"	0.25"	BHU2202	1.43	0.45
		1/4"	5/8"	0.25"	BHU2204	1.85	0.45
		3/8"	5/8"	0.25"	BHU2206	1.85	0.45

†NOTE: CPC's Ferruleless Polytube Fitting terminations do not require ferrules to achieve a secure connection, which makes them easier to use and reuse. PTF fittings are designed for semi-rigid tubing, i.e., polyethylene, nylon, polyurethane, etc.

*NOTE: Gaskets are not included with 10-32 PTF style fittings. To prevent leakage with these fittings, we recommend using LOCTITE® Removable Threadlocker 242 or Permanent Threadlocker 262.

MANIFOLDS - Specifications - Material: Aluminum - Finish: Black anodized

TERMINATION	PIPE THREAD	TUBING	TUBING DIMENSION	PART NO.
10-32 PORTED MANIFOLD WITH 1/8" NPT END PORT	32M5	5	1	3.30"
1/8" NPT PORTED MANIFOLD WITH 1/8" NPT END PORT	2M3	3	1	3.10"
	2M4	4	1	4.00"
	2M5	5	1	4.90"
1/4" NPT PORTED MANIFOLD WITH 1/4" NPT END PORT	4M3	3	2	3.80"
	4M4	4	2	4.80"
	4M5	5	2	5.80"

JG® PUSH-TO-CONNECT ACCESSORIES

DESCRIPTION	TUBING	PART NO.	DESCRIPTION	TUBING	PART NO.
IN-LINE LOCKING CLIPS, RED	1/4" Tube OD	1011900	In-Line Collet Covers, Color Coded	1/4" Tube OD	1012101 to 06
	3/8" Tube OD	1012000		3/8" Tube OD	1012204 to 06

Colors available, shown right. Please indicate color using the following suffix codes: 01=Black, 02=Red, 03=Yellow, 04=Gray, 05=Blue, 06=Green
 (Example: 1012101 is the code for a 1/4" collet cover in black.) NOTE: See pages 46 and 47 for JG couplings.

METHOD

MATERIAL

	DISINFECTANTS			ETHYLENE OXIDE	AUTOCLAVE	E-BEAM IRRADIATION	GAMMA IRRADIATION	DRY HEAT
	FORMALIN	ISOPROPYL ALCOHOL	ETHYL ALCOHOL					
METALS								
302 Stainless Steel	Y	Y	Y	Y	Y	Y	Y	Y
316 Stainless Steel	Y	Y	Y	Y	Y	Y	Y	Y
Chrome-Plated								
Brass-CDA 360	N	Y	Y	Y	Y	Y	Y	Y
POLYMERS								
ABS	N	N/A	Y	Y	N	Y	Y	N
Acetal	Y	Y	Y	Y	Y	N	N	N
LDPE	Y	Y	Y	Y	N	Y	Y	N
Nylon	Y	N	N	Y	N	N	N	N
Polycarbonate	Y	Y	Y	Y	Y	Y	Y	Y
Polypropylene (excludes glass-filled)	Y	Y	Y	Y	N	Y	Y	N
Polysulfone	Y	Y	Y	Y	Y	Y	Y	Y
ELASTOMERS								
Nitrile/Buna-N	Y	Y	Y	N	N	Y	Y	Y
Silicone	Y	Y	Y	Y	Y	Y	Y	Y
Kalrez®	Y	Y	Y	Y	Y	N	N	Y
EPR/EPDM	Y	Y	Y	Y	Y	Y	Y	Y
FKM/Viton®	Y	Y	Y	N	N	N	N	Y

STERILIZATION METHODS

DISINFECTANTS: 70°F (20°C), Formalin, ethyl alcohol, etc. Sterilize coupled or uncoupled.

ETHYLENE OXIDE, ETO: Four hours, 100% ETO @ 110°F (43°C), up to five repetitions, coupled or uncoupled.

AUTOCLAVE:

Acetal: 250°F (121°C), 30 minutes max, up to 10 repetitions. Sterilize uncoupled only.

Polycarbonate: 250°F (121°C), 30 minutes, up to 10 repetitions. Sterilize uncoupled only.

Polysulfone: 270°F (132°C) for 60 minutes, up to 25 repetitions. Sterilize uncoupled only.

Steam-Thru Connection: 265°F (129°C) for 30 minutes, up to two cycles. (part number specific)

HFC39: 270°F (132°C) for 60 minutes, up to 25 repetitions for uncoupled units and up to one repetition for coupled units.

ELECTRON BEAM (E-BEAM): Maximum cumulative exposure of 50 kilograys. Sterilize coupled or uncoupled.

GAMMA: Maximum cumulative exposure of 50 kilograys. Sterilize coupled or uncoupled.

DRY HEAT: 250°F (121°C), 12 hours, no pressure. Sterilize uncoupled only.

SIP PROCESS:

Up to 266°F (130°C) for 60 minutes (Steam-Thru Connection)

Up to 275°F (135°C) for 60 minutes (Steam-Thru II Connection)

Unsure of the chemical compatibility for your application? Consult the ChemCheck tool on cpcworldwide.com or contact CPC customer service to receive product samples for in-house testing and verification.

REGULATORY AND COMPLIANCE

ISO 13485:2003 CERTIFICATION

ISO 13485:2003 is recognized by regulators around the world as a good basis for addressing medical device design and manufacturing regulatory requirements. It allows us to enhance product safety by proactively identifying and managing product and project risks. Becoming ISO 13485:2003 certified has allowed us to better control the consistency of manufactured products.

ISO 9001:2008 CERTIFICATION

ISO 9001:2008 is a standard which assures consistency of a product ordered by customers. Organizations having ISO 9001:2008 certification have demonstrated compliance to the ISO 9001:2008 requirements by an independent registration authority. CPC's Quality Management System has been approved and certified under the ISO 9001:2008 standard.

CLEANROOM MANUFACTURING

CPC manufactures certain Life Sciences and Chemical Management product lines in a cleanroom certified by an external testing service to meet or exceed ISO Class 7 (10,000) at 0.5 mm per ISO 14644 and the former Federal Standard 209E. Certification data is available upon request.

FDA AND USDA

The U.S. Food and Drug Administration publishes, through the Code of Federal Regulations, standardized criteria which govern the acceptability of materials used in food contact. The U.S. Department of Agriculture publishes similar standards that mirror FDA criteria. Neither agency approves or disapproves products for particular applications. Most of CPC's products are made using resins that comply with applicable FDA or USDA standards. When necessary, the standard o-ring seals are replaced with specific, recognized materials.

REACH

REACH is the Regulation for Registration, Evaluation, Authorisation and Restriction of Chemicals. It entered into force on 1st June 2007 to streamline and improve the former legislative framework on chemicals of the European Union (EU). REACH places greater responsibility on industry to manage the risks that chemicals may pose to the health and the environment. CPC publishes a list of CPC products that are compliant with the EU regulation 1907/2006.

REGULATION OF HAZARDOUS SUBSTANCES

The RoHS Directive stands for "the restriction of the use of certain hazardous substances in electrical and electronic equipment." This Directive bans the placing on the EU market of new electrical and electronic equipment containing more than agreed levels of lead, cadmium, mercury, hexavalent chromium, polybrominated biphenyl (PBB) and polybrominated diphenyl ether (PBDE) flame retardants.

NSF

NSF International, based in Ann Arbor, Michigan, develops and publishes consensual criteria that govern the acceptability of materials and equipment used in food and beverage processing. They also do testing to verify the performance of materials or devices to their published criteria. CPC lists many of its product lines under the criteria of NSF/ANSI Standards, which governs components used in food and beverage contact applications.

INDEX

GENERAL PURPOSE COUPLINGS AND CONNECTORS

APC	58
DPC	62
DTLD	48
EFC12	64
Everis BLQ2	80
Everis BLQ4	82
Everis BLQ6	84
Everis LQ2	68
Everis LQ4	70
Everis LQ6	72
Everis LQ8	74
Everis PLQ2	76
Everis PLQ4	78
FFC 35	98
HFC 12	90
HFC 35	94
LC	54
MC	38
NS1	28
NS4	66
NS6	86
NS212	42
NSH	88
PMC	30
PMC12	34
PLC	44
PLC 12	50
SMC	24

MULTI-LINE COUPLINGS AND CONNECTORS

Multi-Mount	106
TenTube	102
TwinTube and SixTube	104

ENHANCED FUNCTIONALITY COUPLINGS AND CONNECTORS

Hybrid	112
Intelligent Fluid Connectors	115
Mini Hybrid	114

MEDICAL GRADE COUPLINGS AND CONNECTORS

Back to Back	127
MPC	124
MPX	128
Sanitary	130
SaniQuik	132
SMC	122

HIGH PURITY COUPLINGS AND CONNECTORS

ChemQuik Dual Container	139
CQG	138
CQH	136

DISPENSING COUPLINGS AND CONNECTORS

BQ45GL	142
DrumQuik, DrumQuik PRO, DrumQuik PUR	144
Puncture Seal	154
UDC	152

FITQUIK FITTINGS, LUERS AND BLOOD PRESSURE CONNECTORS

Blood Pressure	162
Luers	162
Plugs and Thread to Thread	160
Thread to Tube Fittings	160-161
Tube to Tube Fittings	158-160

ACCESSORIES

Caps and Plugs	166
JG Push to Connect Locking Clips	167
Manifolds	167
Nuts and Ferrules	166
O-Rings and Seals	166





Colder Products Company®

COLDER PRODUCTS COMPANY
2820 CLEVELAND AVE. N.,
ROSEVILLE, MINNESOTA 55113
U.S.A.

PHONE: +1 (651) 645-0091
FAX: +1 (651) 645-5404
TOLL FREE: +1 (800) 444-2474

COLDER PRODUCTS COMPANY GMBH
KURHESSENSTRASSE 15
64546 MÖRFELDEN-WALLDORF
GERMANY

DOVER (SHANGHAI) INDUSTRIAL CO., LTD.
ROOM 1802, BUILDING A, IBC,
391 GUIPING ROAD, XUHUI DISTRICT,
SHANGHAI, CHINA 200233

PHONE: +86 21 2411 2666
TOLL FREE: +86 400 990 1978

cpcworldwide.com
info@cpcworldwide.com

Distributed by:

CPC WARRANTY STATEMENT: CPC (Colder Products Company) warrants its products against defects in workmanship and materials for a period of 12 months from the date of sale by CPC to its initial customer (regardless of any subsequent sale of the products). This warranty is void if the product is misused, altered, tampered with or is installed or used in a manner that is inconsistent with CPC's written recommendations, specifications and/or instructions, or fails to perform due to normal wear and tear. CPC does not warrant the suitability of the product for any particular application. Determining product application suitability is solely the customer's responsibility. CPC is not liable for special, indirect, incidental, consequential or other damages including, but not limited to, loss, damage, personal injury, or any other expense directly or indirectly arising from the use of or inability to use its products either separately or in combination with other products. ALL OTHER WARRANTIES EXPRESS OR IMPLIED, WHETHER ORAL, WRITTEN OR IN ANY OTHER FORM, INCLUDING BUT NOT LIMITED TO WARRANTIES OF MERCHANTABILITY OR FITNESS FOR A PARTICULAR PURPOSE, ARE EXPRESSLY EXCLUDED. The sole and exclusive remedy under this warranty is limited, at the option of CPC, to replacement of the defective product or an account credit in the amount of the original selling price. All allegedly defective CPC products must be returned prepaid transportation to CPC, together with information describing the product's application and performance, unless otherwise authorized in writing by CPC.

CPC PATENT STATEMENT: CPC takes pride in its innovative quick disconnect coupling and fittings solutions, many of which have been awarded United States and international patents. CPC has a strong tradition of leadership in the quick disconnect market, and aggressively pursues and protects its proprietary information and intellectual property. In cases where it is practical and has a benefit to its customers, CPC has licensed its proprietary technology. Please contact CPC to discuss your unique needs.

COLDER PRODUCTS COMPANY TRADEMARK STATEMENT: AseptiQuik®, BottleQuik®, BreakAway®, ChemQuik®, Colder Products®, Colder Products Company®, CPC®, DrumQuik®, FitQuik®, IdentiQuik®, MPU®, MPX®, Nu-Seal®, PLC®, Smart Fluid Handling to Take You Forward, Faster®, SnapQuik®, Steam-Thru®, and Softube® are registered trademarks with the U.S. Patent & Trademark office. Everis™, IntelliQuik™, MicroCNX™, MicroDNX™, MPC™, SaniQuik™, Sixtube™, Tentube™ and Twin Tube™ are trademarks of Colder Products Company. All other trademarks or service marks are property of their respective owners.

COPYRIGHT © 2021 COLDER PRODUCTS COMPANY. All rights reserved. Colder Products Company, Colder Products and CPC are registered trademarks with the US Patent & Trademark Office.

WARNING: Due to the wide variety of possible fluid media and operating conditions, unintended consequences may result from the use of this product, all of which are beyond the control of CPC. It is the user's responsibility to carefully determine and test for compatibility for use with their application. All such risks shall be assumed by the buyer.